

Fauna of
New Zealand

Editorial Advisory Group

Members at Entomology Division
Department of Scientific and Industrial Research
Mount Albert Research Centre
Private Bag, Auckland, New Zealand

Ex officio

Director – Mr J. F. Longworth
Group leader,* Systematics Section – Dr G. W. Ramsay

Co-opted from within Systematics Section

Dr T. K. Crosby, Dr B. A. Holloway

Universities representative*

Dr G. W. Gibbs
Zoology Department, Victoria University of Wellington
Private Bag, Wellington, New Zealand

Museums representative*

Dr J. C. Yaldwyn
Director, National Museum of New Zealand
Private Bag, Wellington, New Zealand

Overseas representative*

Dr J. F. Lawrence
CSIRO Division of Entomology
P.O. Box 1700, Canberra City, ACT 2601, Australia

*on a rotational basis

—⊗—

Series Editor

Mr C. T. Duval
Systematics Section, Entomology Division
Department of Scientific and Industrial Research
Mount Albert Research Centre
Private Bag, Auckland, New Zealand

Fauna of New Zealand

Number 12

Pompilidae

(Insecta: Hymenoptera)

A. C. Harris

Otago Museum

Great King Street, Dunedin, New Zealand

Cataloguing-in-publication citation

HARRIS, A. C.

Pompilidae (Insecta: Hymenoptera) / A. C. Harris – Wellington :
DSIR Science Information Publishing Centre, 1987.

(Fauna of New Zealand, ISSN 0111-5383; no. 12)

ISBN 0-477-02501-3

I. Title II. Series

UDC 595.794.23

Date of publication: see back cover of subsequent numbers

Suggested form of citation

Harris, A. C. 1987: Pompilidae (Insecta: Hymenoptera). *Fauna of New Zealand [no.] 12.*



This publication was produced by offset lithography. The author's typescript was transcribed by OCR scanning on to text processor diskette, and after editing and style coding was phototypeset at the N.Z. Government Printing Office. Times New Roman type is used for most of the text; major headings and figure labels are set in Univers; Garamond and Geneva are used in the titles.

The Editorial Advisory Group and the Series Editor acknowledge the following co-operation.

DSIR Research Orchard, Havelock North:

Mrs T. Crockford – assistance with word processor input

Mount Albert Research Centre, DSIR:

Mrs R.L. Harding – transcription of text

Mr D.W. Helmore – assistance with artwork

Mr M.B.B. Irwin – photoreduction of line figures

Mrs H.A. Whelan – computer file management

Science Information Publishing Centre, DSIR:

Dr N. Hawcroft – supervision of production and distribution

Mr C. Matthews – assistance with production and publicity

Science Mapping Unit, DSIR:

Mr T. Savage – assistance with artwork



Front cover: The insect depicted is *Sphictostethus nitidus* (Fabricius), ♀, dragging a prey spider, *Miturga frenata* Koch

© Crown Copyright

Published by Science Information Publishing Centre, DSIR
P.O. Box 9741, Wellington, New Zealand



Frontispiece *Prionemis* (*T.*) *monachus* third-instar larva on its host *Cantuaria allani*.

—❧—

*This study is dedicated to my mother
and to the memory of my father*

—❧—

ABSTRACT

Eleven species of Pompilidae are recognised from New Zealand, of which ten are endemic. The four genera belong to two subfamilies: Pepsinae – *Cryptocheilus* Panzer, *Priocnemis* Schiödte, *Sphictostethus* Kohl; and Pompilinae – *Epiompilus* Kohl. *Chrysocurgus* Haupt and *Trichocurgus* Haupt are removed from synonymy with *Chirodamus* Haliday. *Trichocurgus* is reinstated as a subgenus of *Priocnemis*, and *Chrysocurgus* is synonymised with *Sphictostethus*, which is restored to generic status within tribe Pepsini. Ten specific names are placed into synonymy. *Priocnemis* (*Trichocurgus*) *ordishi*, *Priocnemis* (*T.*) *crawi*, and *Sphictostethus calvus* are described as new. The sexes are correctly associated for all species, most for the first time. All previously known species are redescribed, morphological structures of adults and larvae are illustrated, and keys are given to tribes, genera, and species for adults (both sexes) and larvae. Taxonomic decisions are supported by data on biology, behaviour, and distribution. Behaviour, nesting cycles, life histories, and final-instar larvae are described for all species. Three species nest above ground. Of these, *Epiompilus insularis* Kohl oviposits directly on spiders, usually in situ within their retreats, without making nests; *Sphictostethus fugax* (Fabricius) is a mud-dauber favouring beetle pupal chambers in trees; and *Sphictostethus calvus* nests in rotting logs. *Priocnemis* (*Trichocurgus*) *nitidiventris* (Smith) makes single-celled nests exclusively in sand. The other species nest below ground in diverse habitats, making either single-celled nests or multi-celled nests which in some species may be used by many generations over a period of years. Geographical variation (including mimicry and parallel ecophenotypical colour variation) is described, and distributions of all species are indicated. In four species melanism varies clinally from Spirits Bay (34°27'S) to Port Pegasus, Stewart Island (47°14'S) in relation to climatic factors. Varying degrees of melanism were induced experimentally in some species (but not in others) by lowering the temperatures experienced by the pupa. Abrupt disruptions in the clines occur at the sites of past and present geographical barriers; hence seven subspecies or races can be recognised, but these are not named. Extralimital relationships of the New Zealand species are indicated. *Cryptocheilus australis* (Guérin) was introduced from Australia in the past three decades. *E. insularis* has strong Australian affinities, and the three *Sphictostethus* species are closely related to species in Tasmania and Chile. Extensive host records are given for all species.

CHECKLIST OF TAXA

(All species except *Cryptocheilus australis* (Guérin) are endemic to New Zealand.)

	Page
Subfamily PEPSINAE	25
Tribe Pepsini	25
Genus <i>Cryptocheilus</i> Panzer, 1806	25
<i>australis</i> (Guérin, 1830) new combination	25
Genus <i>Priocnemis</i> Schiödte, 1837	29
Subgenus <i>Trichocurgus</i> Haupt, 1837 new status	29
<i>monachus</i> (Smith, 1855) new combination	33
(= <i>monarchus</i> Hutton, 1874; lapsus calami)	
(= <i>triangularis</i> Cameron, 1898) new synonymy	
<i>conformis</i> Smith, 1876 new combination	38
(= <i>diligens</i> Smith, 1876) new synonymy	
(= <i>marginatus</i> Smith, 1876) new synonymy	
<i>nitidiventris</i> Smith, 1878 new combination	46
(= <i>carbonarius</i> Smith, 1885; misidentification)	
(= <i>huttoni</i> Cameron, 1898)	
<i>ordishi</i> new species	51
<i>carbonarius</i> (Smith, 1885) new combination ..	55
(= <i>nitidiventris</i> Smith, 1878; misidentification)	
<i>crawi</i> new species	59
Genus <i>Sphictostethus</i> Kohl, 1884	63
<i>nitidus</i> (Fabricius, 1775) new combination	66
(= <i>fugax</i> Fabricius, 1775; misidentification)	
(= <i>wakefieldii</i> Kirby, 1881)	
<i>calvus</i> new species	76
<i>fugax</i> (Fabricius, 1775) new combination	84
(= <i>maculipennis</i> Smith, 1876)	
(= <i>huttonii</i> Kirby, 1881; ♀ only – misidentification)	
(= <i>huttoni</i> Kirby, 1883) new synonymy	
(= <i>xenos</i> Kirby, 1883) new synonymy	
(= <i>fujax</i> Gourlay, 1927; lapsus calami)	
(= <i>brownii</i> Gribodo, 1884) new synonymy	
(= <i>browni</i> Hutton, 1904; lapsus calami)	

Subfamily POMPILINAE	93
Tribe Epipompilini	94
Genus <i>Epipompilus</i> Kohl, 1884	95
<i>insularis</i> Kohl, 1884	95
(= <i>epipompilus</i> Dalla Torre, 1897)	

CONTENTS

	Page
Acknowledgments	8
Introduction	9
Morphology	10
Adult	10
Final-instar larva	12
Geographical variation	13
Structural variations	13
Parallel colour variation	13
Geographically separated colour morphs	14
Mimicry	15
Mimicry complexes	15
Effects of thermal melanism	16
Nesting behaviour	16
Faunal relationships	17
Subfamily Pompilinae	17
Subfamily Pepsinae	17
Interpretation of characters and evolutionary relationships	18
Methods and conventions	21
Key to genera	22
Behavioural key to adult females	24
Descriptions (see 'Checklist of taxa')	24
References	102
Appendix 1: Measurements of adults of the endemic species of Pompilidae	108
Appendix 2: Host records for Pompilidae in New Zealand	112
Illustrations	115
Taxonomic index	150

ACKNOWLEDGMENTS

Many people helped me with this study. Mr E. W. Valentine was of great assistance, especially during the initial stages. Dr G. W. Gibbs and Professor J. A. F. Garrick (Victoria University of Wellington), Professor G. S. Satchell and Mr A. W. Don (Otago University) gave help at all stages. Without Dr T. K. Crosby's constant encouragement this account would not exist. Dr R. C. Craw gave many specimens, and much useful discussion and encouragement. Mr S. Smith (Ranger, Piano Flat), Mr F.

David (Ranger, Peel Forest), and Dr R. W. Ballentine (Director, Auckland University Marine Biological Laboratory, Leigh) gave me the use of facilities for rearing larvae through to the cocoon stage, when they could be transported. Mr Smith kindly kept his room at a more or less constant 22°C, even lighting log fires especially for that purpose. Mr R. G. Ordish (National Museum of New Zealand, Wellington) gave generous and invaluable assistance with various aspects of this work. Mr J. S. Dugdale and Mr E. W. Valentine identified several mimics. Dr B. J. Donovan identified the solitary bees whose burrows were used by pompilids for nests. Dr C. A. Fleming discussed some aspects of paleontology with me. Mr E. S. Gourlay showed me a number of unusually good pompilid sites around Nelson. Mr J. R. Grehan gave me valuable specimens and information. Ms D. Willis gave me several useful collections, including one from Bali.

Mr M.C. Day compared selected specimens of New Zealand species with primary type material held in the British Museum (Natural History), and sent me the type series of *Priocnemis wakefieldii* Kirby. Professor H. E. Evans (Harvard University, U.S.A.), Dr R. Wahis (Belgium), Dr A. S. Menke (Systematic Entomology Laboratory, USDA, U.S.A.), and Dr M. Fischer (Natural History Museum, Vienna, Austria) gave me much useful information. Overseas specimens related to the New Zealand fauna were given, exchanged, or loaned by Dr R. Fischer (Michigan State University, U.S.A.), Dr H. Wolf (Pleittenburg, Germany), Dr E. Riek (CSIRO, Australia), Mr J. Kojima (Ibaraki University, Japan), Dr A. R. Alsina (Museo Argentino de Ciencias Naturales, Argentina), Mr M. Monguillon (Paris, France), Dr K. Chang-Whan (College of Science and Engineering, Korea), and Miss A. Green (Tasmanian Museum, Australia).

Material from New Zealand institutions was loaned by Dr G. Kuschel (Entomology Division, DSIR), Mr K. A. J. Wise (Auckland Institute and Museum), Mr R. G. Ordish (National Museum), Dr D. R. Cowley (Auckland University), Mr P. M. Johns (Canterbury University), Professor R. A. Harrison (Lincoln College), Dr B. J. Donovan and Dr R. Macfarlane (Entomology Division, DSIR), and Dr R. R. Forster (Otago Museum). Additional specimens were given by Dr K. J. Fox, Mr J. Chambers, Mrs J. McLennan, and Professor J. Child, and later by Dr B. I. P. Barratt. Mr P. Salmon and Mr L. Morgan helped me in the field at Piano Flat and Peel Forest, and Mr J. Cox was of invaluable help at Dargaville. Miss R. Campbell gave valuable assistance. Mr A. Tomlinson (Meteorological Service, Wellington) gave me invaluable climatic data.

Mr D. Sanderson (Otago University) photographed cocoons and wings

Miss K. Buchan plotted localities on the distribution maps. For translations I am grateful to Mr D. B. Carrad and Dr A. Scobie (Victoria University of Wellington), Mr A. Gemmell (Hydatid Research Unit), Miss F. Kennedy, Mrs E. Collins, Professor R. G. Stone, and Professor J. A. Barsby (Otago University).

Dr R.R. Forster identified most prey species and gave me very useful information on the habits of spiders.

I also thank my parents, who have patiently supported this, and all my entomological activities for as long as I can remember.

INTRODUCTION

The family Pompilidae (spiderwasps) comprises long-legged, solitary wasps that provision their nest cells exclusively with spiders. The females can often be seen during summer running rapidly over the ground, with their wings periodically flicking, as they search for prey. Most will cease activity whenever a small cloud causes a shadow, for heliotaxis (requiring sunlight for movement) is a characteristic of the family.

Pompilidae characteristically use a single prey item to provision each nest cell; the paralysed spider is dragged backwards across the ground; the female uses the apex of her abdomen as a trowel and as a hammer during preparation of the nest burrow; and usually (and in contrast to most other wasps) the prey is caught before the nest is prepared. However, New Zealand species variously do not exhibit one or other of the last three traits, although the first one always applies. Some overseas species are said to be host-specific, but New Zealand's pompilids take a range of prey species and hunt by habitat.

Adult pompilids are distinguished from most other wasps by the presence of a single, straight, transverse groove that divides the mesopleuron into upper and lower halves (see Figure 8); the larvae differ from those of many other solitary wasps in having the second pair of thoracic spiracles greatly reduced.

The family has long been in need of revision. Hitherto, descriptions had been based either on single specimens or on very small series, and a number of nominal species had been erected without comparison with previously described species. As colour variation is very marked, involving both body pigmentation and banding and infuscation on the wings, it is not surprising that many synonyms have arisen.

This contribution is an abridgement of Harris (1974), which was a first attempt at revision of the New Zealand Pompilidae, based on three seasons' intensive collecting and observation in the field. From November 1971 to April 1972, and from September to April of 1972-73 and 1973-74, I collected some 30 500 pompilids around New Zealand, from Cape Reinga to southern Stewart Island. To these were added the relatively few specimens contained in the country's main insect collections. For transport I used a 180 cc motorscooter fitted with additional carrying bags. This enabled me to operate from a tent, servicing Malaise traps, observing adult wasps, and checking larvae developing in pots within improvised cages, over a radius of about 450 km. After 1-3 weeks in an area a new site would be selected. Routes taken and major collecting stations are mapped in Harris (1974, appendix figure 01).

It became apparent to me during this study that in the Pompilidae behaviour, morphology, and ecological niche are closely interrelated. For many taxa, consequently, behavioural studies have facilitated accurate taxonomic interpretation of morphology, especially where convergent evolution is involved. Similarly, comparative larval morphology has provided a check on the classification based on adults.

Three facts were fundamental to my assessment of the taxonomic standing of geographical isolates and colour forms, many of which had been named: (i) in four species melanism varies clinally from Spirits Bay (34°27'S) to southern Stewart Island (47°16'S) in relation to climatic factors; (ii) varying degrees of melanism can be induced in some species (but not in others) by lowering the temperatures experienced by the pupa; (iii) disruption in the clines occurs at the sites of past and present geographical barriers.

An understanding of mimicry complexes has provided a further insight into some patterns of geographical variation.

It has been deeply rewarding to discover for myself that a seemingly complex taxonomic picture is amenable to simplification by way of intensive, regionally representative study in the field. An holistic approach to insect systematics appears to offer insights that may not emerge from studies based on the narrower view of comparative morphology alone. Many professional systematists — perhaps most — are unable to spend months at a time in the field, from year to year, gathering study material and observations that will enable them to piece together a composite view of a taxonomic group. Probably this situation will not change much, and this highlights two very important needs: the need for meticulous recording of biological data in

support of specimens taken from the field; and the need for close co-operation between those who hold specimens and data and those wishing to study them.

Type specimens

Type specimens of almost all New Zealand species are in the British Museum (Natural History), where Mr M. C. Day has made comparisons between them and typical specimens sent to him. The holotype of *Sphex nitida* Fabricius, 1775 has been lost; the type material of *Agenia brownii* Gribodo and *Cryptocheilus australis* Halliday is in the Museo Civico di Storia Naturale "G. Doria", Genoa (in good condition); and the syntype series of *Epipompilus insularis* Kohl is in the Naturhistorisches Museum, Vienna.

MORPHOLOGY

ADULT. Salman (1929) provided a general discussion of the external morphology of an adult pompilid. A number of his interpretations are incorrect, and most later taxonomic studies have used additional terms, with the result that for many structures there has been a considerable proliferation of names. For these reasons the morphological features used here are discussed in some detail, and a list of synonyms in current use for the male genitalia is given.

Because sexual dimorphism is pronounced, many characters of taxonomic importance in females are not present on males, and vice versa.

Head (Figures 3 and 4). Many taxonomically important characters are found on the head. The mandibles have either one or two teeth on the inner margin, conditions termed "unidentate" and "bidentate" by Evans (1950), who — unlike other workers (e.g., Townes 1957) — does not consider the apex to be a tooth. Both the clypeus and the labrum are variable, and are useful taxonomically: for instance, a ratio derived by dividing the length of the clypeus by its width is used at the species level. The eyes, ocelli, frons, and vertex provide useful characters, many expressed in the form of ratios. The ratio POL:OOL is widely used, POL (post-ocellar line) representing the distance of the posterior ocelli from one another; this is divided into OOL (ocello-ocular line), the distance of one posterior ocellus from the nearest point of the compound eye. Evans (1950) measures as well the distance between the compound eyes at three places: the upper interocular distance (UID); the middle interocular distance (MID), which is the distance between the eyes at their greatest emargination; and the lower interocular distance (LID), between the

eyes at their point of closest convergence below. The maximum breadth of the head is termed the transfacial distance (TFD), and the height from clypeus to vertex is the facial distance (FD). The former divided into the latter gives another ratio (Figure 3).

The malar space, here regarded as the shortest distance between the lowest part of the compound eye and the mandible, is often useful to distinguish between closely related species. (I have followed Evans — e.g., 1950, 1973 — in dividing the malar space measurement into the length of the second antennal segment. This ratio is no less reliable than that obtained by dividing the malar space into the width of the jaw at its base. In 1974 it was my wish that the descriptions of New Zealand Pompilidae should be readily comparable with those of Evans, who has already described many of the Pompilidae of the Southern Hemisphere.)

The labium and maxilla (Figure 4) have characters useful at the specific and subgeneric level, such as the relative length of maxillary palp segments and the development of the premental bristles.

Male antennae have 13 segments, whereas female antennae have 12. A useful characteristic of specimens in collections is that the antennae of males are gently arched but those of females are more tightly curled.

Thorax. The transverse collar is separated from the rest of the pronotum by a sulcus, the streptaulus. The pronotal lobe is close to the tegulae. Ventrally the large propleuron faces the tempora, and the prosternum — situated between the coxae — is very reduced.

The mesothorax consists of a mesoscutum ("Mesonotum" of Evans 1950) and a posterior scutellum with a flat or rounded discoidal area and declivous sides. Anteriorly the prescutal sulci are minute or absent. Parapsidal sulci extend from the front half-way on either side of the mesoscutum, the area lateral to them being termed the parapsides. (In *Epipompilus insularis* they extend the full length of the mesopleuron.) A groove partially separates the mesepimeral and mesepisternal parts of the mesopleuron. The large mesopleura meet mid-ventrally, the mesosternum having been eliminated.

The metathorax has a raised metanotum and a depressed metapostnotum, the latter continuous with the metapleura.

The terminology for the thorax used here is illustrated in Figures 5 and 7 (*Priocnemis (Trichocurgus) conformis* — Pepsinae) and Figures 6 and 8 (*Epipompilus insularis* — Pompilinae).

Thorax plus propodeum. Students of aculeate Hymenoptera usually consider the first abdominal

segment in conjunction with the thorax. Thus, Haupt (1938) proposed the term *holmus* for thorax plus propodeum in Dryinidae, and Michener (1944) proposed the equivalent term *mesosoma* in bees. Alitrunk is often used for this region, especially in ants (e.g., by Bolton 1973), and *truncus* is sometimes used as well (e.g., by Brown & Kempf 1969). In descriptions earlier than 1914 the entire region is usually termed thorax. *Mesosoma* is most widely used today, and has been adopted here.

Wings. In Hymenoptera the wing venation is more removed from the generalised type than in any other order of insects. It is possibly for this reason that contemporary pompilid systematists use a varied terminology for wing and cell morphology. Many workers (e.g., Townes 1957) use the system of Rohwer & Gahan (1916), which is a modification of the Jurine system constructed over a hundred years ago. Though simple, it makes no attempt to homologise the venation with that of other insects.

Some European workers use a system devised especially for the Pompilidae by Haupt (1962). It differs from most others mainly in that the cell is always named according to the vein directly above it.

Ross (1936) advanced a system based on the research of workers in insect phylogeny, particularly on critical comparisons between the wings of Hymenoptera and Mecoptera. (Modern entomologists consider the Hymenoptera to have an ancient mecopteran origin, and to be the most primitive of the panorpoid group — e.g., Malyshev 1966.) Ross's system has been widely used, for instance by Evans (1950), Lanham (1951), Michener (1944), Richards (1956), Riegel (1949), and Riek (1970). Because it is arguably the most valid of the existing systems, and is "the most successful attempt to establish a universally applicable system" (Richards 1956), I have used it here as modified by Richards's interpretation. Its terminology is shown in Figures 9 and 10.

Legs. The legs are unusually long. Females often have a dorsal comb-row of teeth or tubercles on the hind tibia. The presence or absence of such teeth or tubercles, as well as the shape of the teeth, is of great importance for distinguishing between the New Zealand species. Legs of females may be smooth, or covered with spines and setae. The shape and position of the single tooth on the tarsal claw and the numerous setulae on the pulvillar pad of the tarsus are used taxonomically.

Metasoma. The remaining abdominal segments are variously termed the abdomen, gaster, or metasoma. The dorsal and ventral plates of each segment (tergum, sternum) are termed tergite and sternite by some authors. The male metasoma con-

sists of seven visible segments. The sixth is emarginate posteriorly, where it bears a pair of small processes on either side. The seventh apparent sternum — morphologically the ninth — forms the subgenital plate (Figure 11) and closes the genital chamber. It is taxonomically very useful at the species level. Across its basal part and entirely within the abdomen lie the basal sclerites, which constitute the true eighth segment.

Male genitalia: structure and synonymy. The male genitalia have proved to be very useful, both for distinguishing between the New Zealand species and as indicators of interspecific relationships. The external genitalia are attached to the hind margin of the ninth segment, and share a common plan with those of most hymenopteran groups. However, the parts are known by an extraordinary number of different names. Those of the early workers are partly listed in Boulangé's (1924) work on the Symphyta. Snodgrass (1941) devised a terminology which has been widely used because it provides the only survey of the structures in all families. However, like most workers who have studied the development of the male genitalia, Snodgrass denies that they include any abdominal appendages, claiming that the parts developed from the primordial penis by secondary sclerotisation in the wall. Conversely, studies based on the comparative anatomy of genitalia of different orders conclude that the parts arose from abdominal appendages, and that only the inner part corresponds to the aedeagus — e.g., Michener (1944a, b), Peck (1937), Smith (1970). The fact that the controversy has yet to be resolved probably accounts for the continued use of a great many terms. Because taxonomists working on Pompilidae over the past two decades have used up to eight different terms for the same structure, I have included a list of synonyms (p. 12). For this study I have used the terminology of Evans (1950), which is based on that of Snodgrass (1941), with minor modifications.

STRUCTURE (Figure 12). The basalmost part of the genitalia consists of a short, hollow cylinder, the basal ring. Beyond this the elongate, median aedeagus is attached to the phallobase by a pair of basal apodemes. On either side of the aedeagus are the parapenial lobes, which are always devoid of setae. External to those structures are the volsellae, of which the distal, elongate *digitus volsellaris* is very variable between species, both in general shape and in the number and type of sensillae it bears. Its expanded proximal part often bears setae. The outermost appendages are the parameres. These frequently have a raised, heavily pigmented area near the base. I have followed Evans (1950) in terming this area the *squama*, although Townes

(1957) uses this term for the entire paramere. A pair of laminae volsellares lie ventrally between the basal plates, and are produced into one or two sclerotised spines, the basal hooklets, which project towards the aedeagus.

SYNONYMY. The term used in this study is given in bold type, followed by its synonyms in normal type.

aedeagus (e.g., Evans 1950)
aedeagus (e.g., Priesner 1965, 1966)
penis (e.g., Haupt 1962, Arnold 1950, 1951)
spatha (e.g., Wolf 1960, Smith in Tuxen 1970)
valve peniala (e.g., Scobiola 1963)
penis valve (e.g., Richards 1956)
lamina aedeagales (e.g., Ford & Forbes 1980)
parapenial lobes (e.g., Evans 1950, Richards 1966, Townes 1957, Smith 1970)
lobi parapeniales (e.g., Priesner 1965, 1966)
forcipes intermediae (e.g., Haupt 1962)
sagitta (e.g., Wolf 1960)
lobe dorsal (e.g., Scobiola 1963)
inner or dorsal arm of the stipes (e.g., Arnold 1950, 1951)
digitus volsellaris (e.g., Evans 1950)
parameres interiores (e.g., Priesner 1965–66)
forcipes exteriores (e.g., Haupt 1962)
volsella (e.g., Wolf 1960)
digitus (e.g., Richards 1956)
inner paramere (e.g., Arnold 1950, 1951)
volselle (e.g., Scobiola 1963)
parameres (e.g., Evans 1950, Richards 1956)
squama (e.g., Townes 1957)
parameres exteriores (e.g., Priesner 1965–66)
Gonopoden des 9 Segmentes (e.g., Haupt 1962)
stipes (e.g., Wolf 1960)
outer or central arm of the stipes (e.g., Arnold 1950, 1951)
gonostyle (e.g., Scobiola 1963, Smith 1970)
basal hooklets (e.g., Evans 1950)
lamina volsellaris (e.g., Richards 1956)
cardo (e.g., Evans 1950)
gonobase (e.g., Scobiola 1963, Smith 1970)
basal ring (e.g., Snodgrass 1941, Richards 1956)
lamina annularis (e.g., Forbes & Hagopian 1965)
gonocardo (e.g., Priesner 1965–66)
basis volsellaris (e.g., Evans 1950)
gonocoxite (e.g., Scobiola 1963)
basis paramere (e.g., Richards 1956)
lamina parameralis (e.g., Forbes & Hagopian 1965)

FINAL-INSTAR LARVA. Evans (1959b) described the general characteristics of final-instar pompilid larvae. The following account is given in order to clarify the terminology used here.

Body. The body is white, almost fusiform, somewhat flattened ventrally, with segmental pleural

lobes, and on each segment except the ultimate one is a crease dividing the dorsum into a pair of annulets. The integument bears setae of varying size on the dorsum and pleura, and sometimes bears minute spicules, especially on the venter.

Ten pairs of spiracles are present; the second pair are much reduced. All are complex in structure (Figures 76 and 77).

The primary tracheal opening lies between the bowl-shaped atrium and the sub-atrium, which is often thrown into a large number of tubercles and extends proximally to a constriction in the trachea. Internally the walls of the atrium are lined with small ridges, many of which bear minute, blunt spines. The basal region of the atrium surrounding the primary tracheal opening is termed the collar, and atrial ridges on this part frequently bear larger collar spines. Spines are often borne by the internal walls of the distal part of the sub-atrium as well. The walls of the atrium protrude slightly above the general body surface to form a rim, from which a very narrow, transparent annulus, the peritreme, slightly constricts the atrial opening.

Head (Figure 78). The head is broader than it is high, giving it a subcircular outline in anterior view. The epistomal suture is very indistinct, and the coronal suture appears to be absent. To the front of the head capsule, on either side, lie a pair of pigmented lines, the parietal bands (Michener 1953, Evans 1959b) or "ocular lines" (Short 1953). A short antennal papilla tipped by three sensory cones arises from each unsclerotised, almost circular antennal orbit. The anterior tentorial arms are visible as thick, pigmented lines on either side of the clypeus, and are continuous with thickenings of the integument above each mandibular base, the pleurostomal thickenings. These latter are continuous with the hypostomal thickenings, which extend back from the posterior articulation of the mandible to the posterior tentorial arms. Head setae vary greatly in length and distribution.

Mouthparts. The labrum has two large lateral lobes and a smaller median lobe, and on the disc bears a marginal row of prominent sensory cones, a transverse band of setae, and non-setigerous punctures. The undersurface of the labrum, termed the epipharynx, is spinulose. The mandibles are strong, not more than twice as long as their maximum width, and heavily sclerotised apically; they have one or two setae, and usually bear three teeth. The maxillae (Figure 79) are setose and bear spicules on their lacinial areas, which extend towards the middle. Anteriorly are borne a pair of blunt, papillose projections of roughly the same size, the inner ones being the galeae and the outer ones the maxillary palpi. The labium comprises a large postmentum and a smaller prementum. The latter

bears the spinneret (or silk press), and lateral to it the labial palpi. Characteristic groups of setae on either side of the spinnerets are termed spinneret setae.

The following ratios are used in the descriptions: HW/HH – head width divided by head height (the latter measured without the labrum, because this is extensible);

ML/MW – mandibular length divided by its maximum width;

LS/OD – length of longest head setae divided by maximum diameter of antennal orbit.

GEOGRAPHICAL VARIATION

A detailed account of geographical variation, environmental melanism, mimicry, and biogeography, supported by experimental results, graphs, and illustrations, is given in Harris (1974). The following notes summarise the main points.

Most taxonomic problems have arisen from geographical variation, which is frequently clinal, with interruptions at sites of past and present topographical barriers.

Structural variations

Segments of antennae and palpi progressively shorten and thicken with increasing latitude in some species (e.g., *Priocnemis (Trichocurgus) monachus*, *P. (T.) conformis*).

P. (T.) carbonarius and *P. (T.) crawi* n.sp. both have distinctive populations in Otago in which the size of the malar space and the dorsal teeth on the hind tibial comb rows of females are significantly different.

Teratological abnormalities affecting the body, appendages, and wing venation are surprisingly frequent, and occur in all species.

Parallel colour variation

Four endemic species of Pompilidae show striking parallel clinal variations in the colour of the integument throughout New Zealand. In the north, both males and females of *Priocnemis (T.) conformis*, *Sphictostethus fugax*, and *S. calvus* n.sp. are bright red. In the upper half of the South Island the head and thorax may be black, but the metasoma is always bright red; south of latitude 44°S the entire body is usually shining jet black. In a fourth species, *Epipompilus insularis*, colour variation is restricted to females because sexual dimorphism is unusually marked, males always having the body and appendages black and the wings hyaline. Although colour variation of females parallels the three species listed above, it is less spectacular. Melanism increases regularly southwards from

North Cape (34°25'S) to southern Stewart Island (47°16'S). It occurs as black spots on otherwise red sclerites; there is very seldom a gradual increase in overall tone. Harris (1974) measured the degree of melanism of 2513 adult wasps, and showed that the parallel patterns of increasing melanism are strongly correlated with increasing latitude, cloudiness, and summer precipitation and with decreasing insolation and temperature. Moreover, specimens captured early in the season (e.g., September–November) are slightly darker than those taken late in the season (e.g., February–May).

Harris (1974) reared pupae at different temperatures. Pupae of *Sphictostethus calvus* n.sp. and *S. fugax* kept at 5°C produced black-bodied adults. Red-bodied adults emerged from pupae kept at 20°C regardless of the coloration of the parents. The degree of melanism in *S. fugax* and *S. calvus* was shown to be directly related to the temperature regime experienced by the pupa, whereas in *Priocnemis (T.) conformis* and *Epipompilus insularis* a genetic factor is involved also. Melanism could not be induced experimentally in *S. nitidus* (other than on the mesosoma, beneath the golden pile).

In summarising melanism in the New Zealand Pompilidae, Harris (1974) made the following points.

(1) Four species — *Sphictostethus fugax*, *S. calvus*, *Priocnemis (T.) conformis* (both sexes), and *Epipompilus insularis* (females only) — show gradual and parallel increases in melanism southwards from North Cape to southern Stewart Island.

(2) This corresponds very closely to a number of climatic factors, of which southward decline in temperature and insolation and increase in cloudiness are the most significant.

(3) Pompilidae are generally active only in direct sunlight.

(4) Black adults (*S. fugax*, *S. calvus*, *P. conformis*) were shown to warm up more rapidly and attain higher internal temperatures, higher metabolic rates, and greater activity when exposed to sunlight than red individuals of the same species from the same locality. Preliminary tests suggested that the range of internal temperatures supporting voluntary activity is the same for black and red individuals of the same species (Harris 1974).

(5) The degree of melanism of the adult probably adapts it to the range of temperature and amount of insolation characteristic of a given locality (latitude and altitude).

(6) The critical period for determining the degree of melanism of the adult occurs during pupal development in spring, after the prepupal moult, when pigment deposition in the cuticle begins.

(7) It was shown experimentally that the amount of black pigment in *S. fugax* and *S. calvus* is directly

related to temperature. For instance, offspring of both black and red females reared at pupal temperatures of 24°C were uniformly red, whereas those reared at 5°C were uniformly black. Intermediate pupal temperatures produced adults with predictable proportions of black and red. Experiments on *P. (T.) conformis* and *E. insularis* (females), on the other hand, revealed a greater genetic influence on the occurrence of melanism (Harris 1974).

(8) The experimental results (see (7), above) correlate with field conditions. In southern populations, female *E. insularis* legs and *P. conformis* bodies are uniformly black, unlike those of *S. fugax* and *S. calvus*, in which occasional red-bodied forms occur depending on local microclimates. Dunedin provides good examples of microclimatically induced colour variation in *S. fugax* and *S. calvus*. Both have the abdomen black north of Dunedin on Leith Saddle, which is frequently shrouded in orographic mist. At a comparable altitude on south-eastern Mt Maungatua (south of Dunedin) — which usually escapes orographic mist on days when Leith Saddle is clouded, as well as having higher spring air and ground temperatures — abdomens of *S. fugax* and *S. calvus* are completely red. The Otago Peninsula is sometimes misty, and there both species have the abdomen mostly red but striped with broad bands of black.

(9) Apart from colour-variable areas of mesosomal integument which are concealed beneath golden pile, *S. nitidus* remains uniformly red-bodied throughout its range, showed no increased cuticular melanism on experimental chilling other than on the mesosoma, and (significantly) does not occur in the far south.

Geographically separated colour morphs

Geographical barriers of the past (e.g., Pliocene Auckland Straits, Pleistocene glacial mid Canterbury between the contemporary Rangitata River and Waitaki River) and present (e.g., Cook Strait, Southern Alps) are marked by abrupt disjunctions between adjoining populations of the same species, or by hybrid-zones (Harris 1974). These disjunctions are at the root of many of the taxonomic problems. For example, several geographical isolates have some of the characteristics of subspecies, or even full species. I have adopted a lumping approach to their taxonomy, and regard them as polytypic species. For instance, *Sphictostethus nitidus* has three clear-cut forms, separated respectively by Cook Strait, where there is a complete disjunction, and by the former Auckland Straits, where there is a narrow hybrid zone. In *P. conformis*, distribution patterns and relative numbers of red and black forms, together with (unpublished) data from limited electrophoretic tests, suggest that

populations in the mid Canterbury hybrid-zone are not in panmixis. In this roughly 65-km-long band *P. conformis* populations occur in which roughly 47% of individuals have black abdomens, 47% have red abdomens, and the remainder form a complete gradation between the extremes. Within the hybrid-zone there are many areas in which the two colour morphs occur together (e.g., Mills Bush, Peel Forest). In other places the colour morphs are separated both spatially and temporally. In several valleys every individual on one side is black (usually a northeast-facing slope that receives only morning sunlight), whereas the opposite side supports wasps with red abdomens (e.g., at Kelsey's Bush, Waimate).

North of the hybrid-zone all individuals of *P. conformis* have red abdomens and south of it the abdomen is invariably black. Harris (1974) suggested that pre-Pleistocene populations throughout New Zealand formed north-south clines related directly to climate, similar to those of contemporary populations of *S. fugax* and *S. calvus*. A Pleistocene ice cap in the Mt Cook region extending westwards to the sea via piedmont glaciers, combined with periglacial conditions on the east, divided *P. conformis* into two allopatric populations. These would have converged during interglacials.

In New Zealand today insolation is greatest in Marlborough and least in Southland (the approximate positions of Pleistocene refugia), and Harris (1974) suggested that under Pleistocene conditions similar to today's but more extreme, melanism may have become partially genetically fixed in the southern population during one (or more) glacial advances, so that in some interglacials (including the present one) populations in the area of convergence showed many of the signs of secondary intergradation. The situation can just as well be regarded as a zone of balanced polymorphism between two roughly monomorphic populations with, overlain, an environmentally controlled variation of phenotype. Hence, I have regarded the name *diligens* given by Smith (1876) to the melanic form as a junior synonym of *conformis*, which has page priority in the same paper. (The holotype of *diligens*, moreover, is an incompletely melanic form from Peel Forest, at the northern limit of the hybrid-zone.)

Notwithstanding this, overall melanism in *P. conformis* increases fairly regularly southwards throughout its range.

Sphictostethus nitidus comprises three races. A South Island form is separated by Cook Strait from a southern and central North Island form, and this forms a cline between Auckland and Warkworth with a Northland form. The Southern Alps separ-

ate Westland and East Coast forms of *S. fugax*. In both species, geographical forms are distinguishable mainly by differences in wing coloration.

Characteristic forewing patterns of the colour-variable species are shown in Figures 220–236.

MIMICRY

The endemic Pompilidae throughout New Zealand are included in three well established mimicry associations, each having Müllerian and Batesian components. Female pompilids, ichneumonids, and other stinging insects comprise the Müllerian component, while male pompilids and ichneumonids together with sun-loving beetles and flies are Batesian mimics. Male pompilids will sometimes mimic females of another, more common, species. Mimicry in the colour-variable species is selectively less important than variable melanism. Thus, female pompilids switch from a red-and-gold complex to a black-and-yellow one south of latitude 45°S, where reduced insolation and temperature evidently induce the melanism that confers thermal advantage.

Mimicry complex 1: black body and clear wings

COLORATION. Body, legs, antennae, and palpi shining black; wings clear hyaline, or very lightly clouded.

MOVEMENTS. Heliotaxis, and walking in a characteristic jerky manner interspersed with short bursts of flight.

MÜLLERIAN COMPONENT. Females of *Priocnemis* (*Trichocurgus*) *nitidiventris*, *P. (T.) ordishi* n.sp., *P. (T.) carbonarius*, and *P. (T.) crawi* n.sp. (Pompilidae); also various endemic solitary bees, sphecids, and Ichneumonidae.

BATESIAN COMPONENT. Males of the above four species, *Priocnemis (T.) monachus* (males only), various Diptera such as *Pollenia pernix* (Hutton) (Calliphoridae), and elaterids.

REMARKS. This complex favours more open places than the other mimicry associations. Its pompilid elements do not show colour variation.

Mimicry complex 2: red body, yellow thorax, and amber wings

COLORATION. Body bright red except for hind part of thorax, propodeum, and sometimes part of first segment of metasoma, which are glistening yellow; wings tinted with amber; legs red; antennae black. **CHARACTERISTIC MOVEMENTS.** Heliotaxis (appearing almost exclusively in sunlight, and disappearing very rapidly when the sunlight fades). Walking in a bold, jerky manner, with the antennae held out in front, constantly moving, sometimes palpating

the ground (some dipterous mimics compensate for their short antennae by having the first pair of legs black but the other two pairs red, and waving the front legs about like antennae). Taking short flights interspersed with periods of jerky walking.

MÜLLERIAN MIMICRY ASSOCIATES. Ichneumonidae (females) – *Aucklandella utetes*, *A. thyellma*, *A. conspirator*, *A. sp. A*, *A. sp. B*, *Levansa decoratoria*, *L. leodacus*, *L. sp. A*, *Degithina davidi*, *D. exhilarata*, *D. hersilia*, *D. sp. A*, *D. sp. B*; Pompilidae (females) – *Sphictostethus nitidus*, *S. calvus*, *S. fugax*, *Priocnemis (T.) conformis*.

BATESIAN MIMICS. Ichneumonidae (males of above species); Pompilidae (males of above species); Proctotrupidae – *Proctotrupes maculipennis*; Tipulidae – *Gynoplistia cupreapercara*; Stratiomyiidae – *Benhamyia apicalis*; Asilidae – *Saropogon antipodus*, *S. extenuatus*; Cleridae – *Phymatophaea ignea*; Elateridae – *Sphaenelater lineicollis*; Cerambycidae – *Gastrosaris nigrocollis*.

REMARKS. The asilids function as Batesian mimics with respect to avian predation, and as aggressive mimics towards male ichneumonids and pompilids, which sometimes appear to mistake the asilids for females of their own species and fly towards them, when they are eaten. *Proctotrupes maculipennis* is a specific mimic of *Sphictostethus calvus*. The wing coloration, forewing fascia, and apical wing infuscation are strikingly similar, and the body changes from red to black southwards in a notably similar way. Both *Sphictostethus fugax* and *Priocnemis (T.) conformis* are models for *Saropogon extenuatus*.

Mimicry complex 3: black body, yellow abdominal base, amber wings

COLORATION. Head and thorax black; base of abdomen bright orange-yellow; apex of abdomen black; wings tinted with amber, their apices lightly infuscated; coxae and apical parts of tarsi black. (Abdomen always smooth, shining, and devoid of bristles, even in the tachinid mimic *Huttonobasseria verecunda* Hutton.)

CHARACTERISTIC MOVEMENTS. As for the previous mimicry complex.

MÜLLERIAN MIMICRY ASSOCIATES. Ichneumonidae (females) – *Aucklandella geiri*, *A. sp. A*, *A. sp. B*, *Degithina decepta*, *D. sp. A*, *D. sp. B*, *D. sp. C*; Pompilidae (females) (below latitude 43°30'S) – *Sphictostethus fugax*, *S. calvus*, *Priocnemis (T.) conformis*, *Epipompilus insularis*.

BATESIAN MIMICS. Ichneumonidae – males of species listed above; Pompilidae – males of species listed above; Proctotrupidae (below latitude 43°30'S) – *Proctotrupes maculipennis*; Stratiomyiidae – *Benhamyia straznitskii*; Tachinidae – *Huttonobasseria verecunda*.

AGGRESSIVE MIMIC. *Saropogon extenuatus* (Asilidae) is an excellent mimic of melanic *Priocnemis* (*T.*) *conformis* females, to which male pompilids are sometimes attracted, whereupon the asilid captures them.

REMARKS. Both Müllerian and Batesian components appear to be based on *Degithina decepta* females. This complex gains species south of latitude 44°S.

Effects of thermal melanism on mimicry

South of about latitude 44°30' S mimicry complex 2, dominant in northern districts, fades out and mimicry complex 3 gains new associates. This is especially true of species that are strongly subject to thermal melanism, such as *Priocnemis* (*T.*) *conformis*, *Sphictostethus fugax*, and *S. calvus* (Pompilidae), several *Degithina*, *Levansa*, and *Aucklandella* species (Ichneumonidae), *Proctotrupes maculipennis* (Proctotrupidae), *Benhamyia strazniiskii* (Stratiomyidae), *Gastrosarus nigrocollis* (Cerambycidae), and others, which become completely black-bodied and switch to the association with black body, yellow thorax, and amber wings. Several species (such as *Sphictostethus calvus* and *Priocnemis* (*T.*) *conformis*) have the body completely black, i.e., without orange-yellow on the propodeum and the base of the abdomen. The pompilids, however, hold the wings tightly over the back, so that the amber basal part resembles the orange base of the abdomen and the enlarged apical infuscation corresponds to the black abdominal apex. On Stewart Island some *Priocnemis* (*T.*) *conformis* males have the wings entirely infuscated, and the body and appendages are black as well. These resemble members of the black-bodied, clear-winged mimicry complex when running on the ground.

NESTING BEHAVIOUR

Morphology and behaviour are closely interrelated in Pompilidae, as they are in most aculeate Hymenoptera, and taxonomists ever since Linnaeus have sought to include ethological notes in their descriptions of wasps, bees, and ants. In an excellent study on the classification and phylogeny of the social Vespidae, Ducke (1914) made extensive use of nesting behaviour. Wheeler (1923, 1928) undertook similar studies on ants; Plath (1934) proposed a classification of bumblebees based on nesting behaviour; Duncan (1939) showed a close parallel between morphological and biological characters in defining the genera of Vespidae; Spooner (1948) found clear-cut generic and specific differences in the behaviour of the British Pseninae (Sphecidae);

Behavioural sequences (after Malyshev 1966)

A	hunting
ai	seeking the victim
aii	attacking and paralyzing it
aiii	transporting it to a particular place for temporary keeping
B	preparation of the nest
bi	seeking a place for the nest
bii	digging the nest, repairing, etc., usually combined with visiting the prey
C	transporting the prey to the nest and installing it
ci	dragging the prey to the nest
cii	inspecting the nest
ciii	dragging the prey into the nest
D	oviposition
E	closing the nest
ei	closing the cell
eii	closing the nest

and Michener has made comparable discoveries with solitary bees. Evans (1953) constructed a classification of Pompilidae based solely on their comparative ethology, and this very closely paralleled the existing morphological one. Hence, nidification cycles provide revealing taxonomic characters that should be used in classification to support conclusions derived from morphology.

Comparative ethologists of solitary wasps such as Iwata (1942), Arens (1948), Tsuneki (1957), Evans (e.g., 1958), Olberg (1959), Malyshev (1966), and Grandi (1971) have divided the nesting cycles into behavioural sequences which are denoted by letters and numbers. Harris (1974) applied the nesting formulae devised by Arens (1948), Malyshev (1966), and Evans & Eberhard (1970) to the New Zealand species. Nidification formulae based on such sequences are usually arranged in hierarchies ranging from simple to complex. It is frequently assumed that simple nidification formulae represent a lower stage of evolutionary development than more complex ones.

Priocnemis (*T.*) *monachus* usually performs the full set of sequences devised by Malyshev. Not all species do this, however, and many enact the steps in a different order. For example, a more derived species may dig a cell before it hunts a spider, whereas a primitive one often digs its cell after it has captured a spider.

Evans & Eberhard (1970, pp. 114–119) gave a simplified nesting hierarchy which is used in this account. Only the first four stages apply to Pompilidae, as follows:

(1) prey – egg

No nest made; egg laid directly on host – e.g., *Epipompilus insularis*.

FAUNAL RELATIONSHIPS

(2) prey – niche – egg – (closure)

Prey caught outside its own burrow and dragged back into its burrow – no New Zealand examples.

(3) prey – nest – egg – closure

Prey dragged into pre-existing hole which may subsequently be modified by the wasp; prey caught before nest is made or found – e.g., all species in New Zealand (except *E. insularis*); always in *Priocnemis nitidiventris*, which seemingly makes only single-celled nests exclusively in sand; sometimes only in the other species.

(4) nest – prey – egg – (cell) – closure

Multi-celled nests made in soil with cells branching from a main burrow, or a series of cells in wood, separated by mud partitions; nest made before prey is caught – e.g., all species in New Zealand (except *E. insularis* and *P. nitidiventris*), sometimes.

(4a) Prey caught before terminal spur enlarged into cell – e.g., *P. monachus* (sometimes), *P. conformis* (occasionally), *P. ordishi* n.sp., *P. carbonarius* (sometimes), *P. crawi* n.sp. (sometimes).

(4b) Nest cell prepared before prey caught – e.g., *Cryptocheilus australis*, sometimes.

Other aspects of the life cycle provide valuable taxonomic characters. For example, the manner of prey carriage (Figures 170–175) is sometimes of use at the specific and generic levels, and the position of the egg on the spider (shown, inter alia, in Figures 177–202) and the effects of the pompilid's venom are sometimes useful for distinguishing species. Similarly, the types of prey taken have taxonomic significance. Evans (1959b) found that the genera *Poecilopompilus*, *Batozonellus*, and *Episyron*, which are very similar in both adult and larval characters, all use Epeiridae as prey. Evans & Yoshimoto (1962) and Kurczewski & Kurczewski (1968a, b, 1972) found *Priocnemis* to take errant hunting spiders; the first-named authors used this fact in their ethological diagnosis of the genus. In this light it is interesting that two New Zealand *Priocnemis* (*Trichocurgus*) species, *monachus* and *conformis*, prey mainly on mygalomorph spiders.

The New Zealand Pompilidae are extremely varied in their nesting behaviour, ranging from a species that does not make nests (*Epipompilus insularis*) through mud-daubing, tree-nesting species (*Sphictostethus fugax*) to species that dig compound nests (e.g., *Priocnemis* (*T.*) *carbonarius*) which may be used by many generations over several years (e.g., *P.* (*T.*) *monachus*).

The terminology applied to nest structure is illustrated in Figure 176, and representative nests are shown, inter alia, in Figures 177–202.

Endemic Pompilidae belonging to both subfamilies have systematic affinities confined largely to the Southern Hemisphere. This conforms to a pattern which recurs throughout the Hymenoptera, for many diverse groups have a clear Holarctic element and a well defined Paleoaustrian component. For example, clear transantarctic relationships are found in Crabronidae (Leclercq 1952), Apoidea (e.g., tribe Paracolletini; Michener 1964), Diapriidae (Masner 1969), Proctotrupidae (Oglobin 1960), Scelionidae (Masner 1968), and other families and tribes.

Subfamily Pompilinae, tribe Epipompilini

Epipompilus has an essentially southern distribution, with extant species from South America (13; Evans 1967), the United States (1; Evans 1967), South Africa (“one or two”; M.C. Day, pers. comm.), New Guinea (at least 5; Evans 1972), Australia including Tasmania (33; Evans 1972), and New Zealand (1). In addition, Mr M.C. Day (pers. comm.) states that he has a specimen near *Epipompilus* from Malaysia that “widens the scope of the group considerably”. The range of the genus may formerly have been more extensive. For example, Evans (1962) states that species belonging to *Epipompilus* constitute half of the Pompilidae from the Baltic amber in the collection of the American Museum of Comparative Zoology. The genus attains its greatest (extant) diversity in Australia. Of the Australian species described and figured by Evans (1972), a number of eastern and Tasmanian species seem very similar to *E. insularis*. For example, in the male of *E. bushi* Evans (from eastern Australia) the aedeagus, parapenial lobe, digitus, and paramere are very similar in shape to those of *E. insularis*, except that in *bushi* the last-named is much shorter relative to the other lobes. Both the paramere and the digitus have very long, apically hooked setae similar to those of *insularis*. The remaining described aspects of the structure of *bushi* bear a close resemblance to the New Zealand species, and coloration is almost identical. Clearly, the sister-species of *E. insularis* occurs in eastern Australia and Tasmania.

Subfamily Pepsinae, tribe Pepsini

The endemic Pepsinae also have southern, transantarctic affinities. Genus *Sphictostethus* is virtually confined to Chile, New Caledonia, New Guinea, Tasmania, and New Zealand, paralleling the distribution of *Nothofagus*, the southern beeches. The three New Zealand species link the group around *S. gravesii* Haliday with that around *S. xanthopus* Spinola (Chile) plus *S. aliciae* Turner

and *S. xanthochrous* Turner (Tasmania); see Remarks under *Sphictostethus*, p. 63. The affinities of *Priocnemis* subgenus *Trichocurgus* are less clear. *Cryptocheilus australis*, a common Australian species, was accidentally introduced into New Zealand in the early 1960s. It does not occur outside Australia and New Zealand.

The species of Pompilidae native to New Zealand uniformly show evidence of long occupancy, for example by their disjunctive geographical races and the extensive series of Batesian mimics based on the females.

INTERPRETATION OF CHARACTERS AND EVOLUTIONARY RELATIONSHIPS

Interpretation of character-states in Pompilidae is often difficult, because there is a very close correlation between morphology of the adult female, larva, cocoon, and female nidification cycle. Because many characters in *Epipompilus* unrelated to nesting behaviour are assuredly primitive — for example the exerted labrum, the crenulate male antenna, and the form of the larval mandibular teeth — it at first may seem reasonable to conclude that other characteristics, such as the simple nidification cycle, also are primitive. The head of the female projects forwards as in Bethyliidae, and calls to mind a hypothetical bethyliid-like pompilid ancestor. However, this feature is probably derived, being related to the seeking of spiders in very concealed places; and it occurs in conjunction with related modifications such as the incrassate fore femur and short fore tarsus. These and other derived modifications are shared with unrelated species with similar habits. *Epipompilus* has sufficient characteristically pompiline features (e.g., most aspects of the male genitalia) to suggest that the absence of spine-like setae set in pits on the apical part of the female hind femora, and the uneven, splayed setae on the apex of the female hind tibiae — which are usually considered among the chief identifying characters of the subfamily Pompilinae — are secondary reductions relating to its non-fossorial habits. The absence of spines on the underside of the tarsi has a similar explanation.

The squat form, apically depressed metasoma, flat apical sternum, incrassate fore femur, and very short fore tarsus of *E. insularis* (females) are specialisations related to its crawling into crevices, holes, and the retreats of spiders, above the ground. (It is generally thought that the bethyliid- or scolioid-like ancestors of Pompilidae were ground-nesters.)

The cocoon of *E. insularis* is the pale buff colour usual in species nesting above ground; is very thick;

Assessment of the status of some key characters of *Epipompilus insularis*

Primitive

- anal lobe of hind wing very small
- labrum exerted
- antennae of male crenulate
- larva with several mandibular teeth
- larval mandibles lacking paired apical teeth

Either primitive or derived

- head produced forwards (as in Bethyliidae)
- nidification cycle simple — spiders oviposited on in situ, no nest or closing operations made
- paralysis temporary

Derived

- *fore femur and tibia in female short, thick
- *fore tarsus in female very short
- *absence of spurs and spines for digging
- *fore tibiae without spines
- *tarsi without ventral spines
- *absence of uneven, splayed setae on apex of hind tibiae
- *absence of spine-like setae set in pits on apical parts of femora
- *female metasoma depressed apically
- spiracles circular, not elliptical (larva)
- *absence of atrial and collar spines on spiracles (larva)
- antennal papilla long (larva)
- head and thoracic setae long (larva)
- *shape fusiform (larva)
- supra-anal lobe prominent, thick (larva)
- 2nd thoracic tergum with a shield-shaped, toothed structure (larva)
- cocoon exceptionally thick-walled

*associated with supraterrrestrial larvae in confined places

and has the fibres relatively loose, with much trapped air in between. Its thickness probably reflects the fact that the nest is never sealed, and that some cocoons are spun in relatively unprotected places such as curled leaves; occasionally even in places where the already parasitised host happens to stop moving.

Some of the larval characters, such as long antennal papillae and circular spiracles lacking atrial, collar, and subatrial spines, occur in specialised genera (e.g., *Auplopus*, *Dipogon*) and are probably derived. The curious shield-shaped structure on the dorsum of the second thoracic segment (see Figure 110) has not previously been recorded in larval Pompilidae, and may also be derived.

Many of the unusual morphological structures in *E. insularis* can probably be explained by interpreting it as an essentially primitive species, except that it exhibits many derived features through having become adapted to nesting above ground usually in the retreats of spiders that conceal themselves

in tight, enclosed crevices beneath bark, in rolled-up leaves, bag-moth cases, weevil holes in timber, and similar places (see table, above).

Genus *Sphictostethus*

The following shared characters are not obviously adaptive, and probably reflect phylogenetic affinity.

ADULT: forewing with 2nd radio-medial cross-vein slanting obliquely; cell *2Rs* very large, its shape characteristic (see Key-figure 6b), very much wider and longer than cell *1Rs*. Wings often amber-tinted, and frequently banded. (The origin of the long hairs on the underside of the head, viz the prementum, is also primitive in *Sphictostethus*). Propodeum with dense golden pubescence. Male metasoma usually with projections, laterally or medially, on 5th or 6th sternite. Male subgenital plate with a compressed lateral tubercle near its apical articulation with 8th sternum. Male genitalia often with digitus volsellaris complex, bilobed, often with apical part bent inwards at 90°. Parameres often with peg setae on outer margin.

LARVA: sparse, very short setae on head and thorax; clypeus without a median sulcus or impression; labrum with latero-apical angles angular, the median lobe with its apical margin sub-rectilinear; mesal epipharyngeal spicules blunt, uncrowded; cells between anastomosing ridges of spiracular atrium irregular, with vertical extensions.

BEHAVIOUR: hunting of errant, ground-nesting spiders; dragging spiders backwards, held by the base of a hind leg; failure to amputate legs; nests predominately single-celled.

Adaptive characters

S. nitidus. The following features are associated with subterranean nesting, usually in clay.

ADULT FEMALE: scale-like teeth on hind tibiae; ventral spines on 5th tarsal segments; well developed spines on tibiae; bristles well developed on apex of gaster; petiole of metasoma not notably produced.

COCOON: comparatively thick, rigid, opaque, dark brown.

LARVA: head bristles short; setae present (though small) in spiracular atrium and collar; absence of transverse rows of small setae on abdominal and thoracic segments.

S. fugax has the following adaptations to supra-terrestrial nesting and mud-daubing.

ADULT FEMALE: no teeth on hind tibiae, which are extremely smooth almost without spines; 5th tarsal segments without ventral spines; petiole of gaster very produced; epipygeum with reduced spines, and with a (mud-moulding) median, longitudinal carina.

COCOON: pallid, non-rigid, very thin, so prepupa sometimes faintly perceptible within.

LARVA: without atrial or collar spines in spiracles, and with a transverse row of small setae on abdominal and thoracic segments.

All the foregoing adaptations are shared by unrelated, convergently evolving, mud-daubing taxa of tribe Auplopodini (= Macromerini; Townes 1957) and the pepsine genus *Dipogon* (Williams 1919, Richards & Hamm 1939, Townes 1957, Evans & Mathews 1973). *S. fugax* larvae differ from other mud-using, above-ground nesters in lacking very long head and body setae.

While the fascicule of long bristles on the prementum is used by *fugax* to transport mud, it is present also in *calvus*, *nitidus*, and all the extralimital *Sphictostethus* species I have examined. A similar fascicule of long bristles is found in the exclusively mud-manipulating tribe Auplopodini, and in *Dipogon*, although in those species the long bristles arise from the mentum. Genus *Dipogon* and tribe Auplopodini include species nesting in beetle holes in trees, which they fill with mud held in the mental bristles.

Dense golden pile on the propodeum of *nitidus* and *fugax* is primitive in genus *Sphictostethus* and occurs in many extralimital species, including *S. gravesii*, the Chilean type-species of the genus. Hence, its absence in *calvus* is undoubtedly derived.

I regard *fugax* as having evolved from a ground-nesting species, and hence as being a more recent derivative than *nitidus*. *S. calvus* occupies an intermediate position.

The notable similarities of both subgenital plates and male genitalia in *calvus* and *fugax* (Figures 56 cf. 57, 65 cf. 66) attest to a high degree of kinship. *P. (C.) nitidus* is clearly more distantly related. This is shown as well in vein *3rm*, bent in *fugax* and *calvus* but almost straight in *nitidus*, and in the thickened, arc-shaped rim of the clypeus (visible from below) present in *fugax* and *calvus* but absent in *nitidus*. *S. calvus* females have very smooth legs, and faintly perceptible vestiges of the bases of scales on the hind tibiae.

Genus *Priocnemis*, subgenus *Trichocurgus*

Included species are all ground-nesters. The shared adult, larval, and behavioural characteristics (see taxonomic section, p. 00) almost certainly reflect phylogenetic affinity. The basic similarity of the male subgenital plates and genitalia (Figures 49–54, 60–63), which is paralleled by similarity of larval morphology, attests to a high degree of kinship among the species of this subgenus.

P. (T.) monachus has minor differences in wing venation such as elongation of cell *2Rs*. Its large

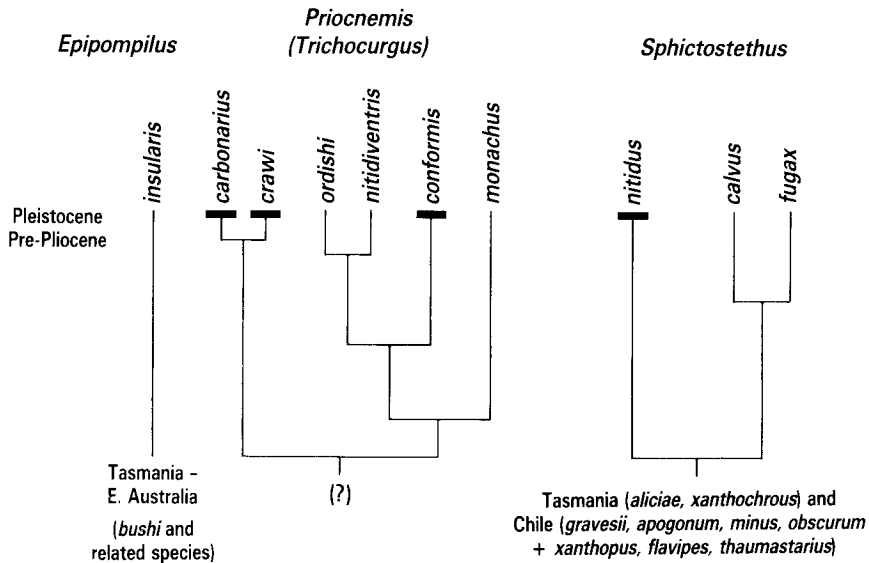

Text-fig. 1 Dendrogram of probable phyletic relationships within the endemic New Zealand Pompilidae (i.e., excluding *Cryptocheilus australis*).

size and hairiness superficially suggest a primitive and scolioid pompilid that would fit well at the base of a dendrogram, a suggestion that has been made (see, e.g., Townes 1957, p. 14). However, most features are highly characteristic of subgenus *Trichocurgus* (as conceived here), and the male genitalia and subgenital plate are very similar to those of the other species (except *carbonarius* and *crawi*), as is the morphology of the larva. Its nests are among the most sophisticated of the endemic species of Pompilidae. I therefore regard *monachus* as being relatively derived.

Amber-tinted wings, red coloration on the body (north of latitude 45°S), and bronzy-aeuneous pubescence distinguish *conformis* from all other *Trichocurgus* species. The male genitalia and subgenital plate, however, very closely resemble those of *nitidiventris* and *ordishi*, and are quite similar to those of *monachus*. Similarly, the frequent appetitive burrowing in loose soil characteristic of *conformis* females closely resembles that of *nitidiventris*. The hind tibia is very similar in *conformis* and *nitidiventris*, and females of both species bear small tumescences in the place of scale-like teeth on the hind tibia. Morphologically the larva of *conformis* is very similar to larvae of *nitidiventris*, *ordishi*, and *monachus*.

P. nitidiventris and *P. ordishi* are very closely related. Obligate psammophiles are rare in the Pep-

sinae, most sand-nesters being pompiline, probably because subfamily Pompilinae is pre-adapted to this niche through the (usual) presence of long setae on the fore tarsus. *P. nitidiventris* probably evolved as a sand-nester because New Zealand lacks ground-nesting Pompilinae. Although *P. ordishi* nests in clay, it pushes prey forward through grass, debris, etc., as a sand-nester does. I think it is recently derived from *P. nitidiventris*, perhaps in relation to the sudden appearance of large areas of clay following the large-scale melting of glacial ice.

In their male genitalia and subgenital plates *carbonarius* and *crawi* differ from the rest of subgenus *Trichocurgus*. The plate lacks the characteristic paired oval depressions at the base. The digitus volsellaris lacks sensillae basiconicae, characteristics of all other *Trichocurgus* species. Wing venation in *carbonarius* and *crawi* closely resembles that of the other *Trichocurgus* species except *monachus*. Throughout its range, *carbonarius* is the most variable and the most confusing. Nevertheless, I think it stands close to the base of subgenus *Trichocurgus*. In the female, the hind tibial scales (and other features) resemble those of *P. exaltata* Fabricius, type-species of genus *Priocnemis*. Of the New Zealand species, *P. carbonarius* and *P. crawi* most closely resemble subgenus *Priocnemis*, and indicate clearly that *Trichocurgus* belongs in that genus, as currently conceived.

My interpretation of the relationships between the endemic species of Pompilidae is shown in Text-figure 1 (more detailed information is given in the sections following each generic diagnosis).

METHODS AND CONVENTIONS

Collecting

Malaise traps made to the specifications of Townes (1972) were operated in patches of sunlight in insect flyways in vegetation. Smaller traps made to Oliver's specifications (Harris 1982) were placed over individual nest sites.

Plastic bags of about 30 × 15 cm were used to capture walking or stationary wasps. Half-pint preserving jars were used when wind prevented the use of plastic bags.

Wasps on the wing were caught in 45-cm-diameter sweep-nets.

Rearing

Larvae were reared in plastic pots measuring 5 cm (diameter) × 4 cm (height). Parasitised spiders were placed in small depressions in compacted, sterile soil, and a small section of leaf, changed each day, was added to maintain the desired humidity.

Experimental crosses between allopatric populations were performed in the field in 2m × 2m × 3m cages lined with fine terylene spray-painted black. Female cocoons from a distant site were placed in the container in early summer. Adult males from a nearby site were introduced after the first female hatched.

Storage of material

Adults were kept in 75% ethanol until they could be pinned, normally after my return from the field. Larvae and host spiders were fixed using van Ermden's method (1942) and then kept in 75% ethanol.

Examination of preserved material

LARVAE. Head capsules were removed and drawn under the microscope. They were then cleared in 10% potassium hydroxide solution and drawn again. Skin and spiracle preparations were similarly cleared and mounted. Larvae of *Priocnemis* (*T.*) *carbonarius*, *Sphictostethus nitidus*, *S. fugax*, and *Epipompilus insularis* were freeze-dried and examined with a Cambridge Mk 2a scanning electron microscope.

ADULTS. Adults were examined with a Zeiss stereomicroscope. Genitalia and subgenital plates were viewed with a Zeiss Standard Junior compound microscope.

Illustrations

Line drawings were made on paper squared to a 1 cm grid, with the aid of a squared lens graticule. Omission of scale lines from the published illustrations is deliberate, owing to the great variability in size of individuals within and between species.

Distance ratios

For descriptive purposes it is convenient to indicate positions and relative areas on a structure as proportions of (usually) its median or maximum length. Hence, "tubercle at 0.63 from ocellus" locates a tubercle at 63% of the distance down the frontal midline from the ocellus; and "frons gibbous on ocellar 0.6 of its length" defines a gibbous area on the upper 60% (by median length) of the frons.

Repository abbreviations

The 32 309 adult New Zealand pompilids examined are deposited in the collections of the following institutions, which are referred to throughout the text by the abbreviations proposed by Watt (1979):

AMNZ	Auckland Institute and Museum, Auckland, N.Z.
BMNH	British Museum (Natural History), London, England
CMNZ	Canterbury Museum, Christchurch, N.Z.
FRNZ	Forest Research Institute, Rotorua, N.Z.
MCSN	Museo Civico de Storia Naturale "G. Doria", Genoa, Italy
NHMW	Naturhistorisches Museum, Wien (Vienna), Austria
NMNZ	National Museum of New Zealand, Wellington, N.Z.
OMNZ	Otago Museum, Dunedin, N.Z.
UCNZ	University of Canterbury (Zoology Department), Christchurch, N.Z.

In addition, over 2600 wasps representing 321 extralimital species having affinities with the endemic species and genera were studied. Regions of origin included North and South America, England, central and southern Europe, Korea, Japan, and Australia (including Tasmania).

Two-letter codes used to denote species distributions are those proposed by Crosby *et al.* (1976).

**KEY TO GENERA OF POMPILIDAE
OCCURRING IN NEW ZEALAND**

ADULTS

01 FEMALE: metasoma without a transverse groove on 2nd sternum and without a lateral incised line on 1st tergum (Key-fig. 1a); labrum extensively visible, appearing almost continuous with clypeus (Key-fig. 2a); fore femora greatly swollen, and segments of fore tarsus unusually short (Key-fig. 3a). MALE: antenna crenulate in lateral profile (Key-fig. 4a)
... (p. 95) .. POMPILINAE, *Epipompilini*,

Epipompilus

— FEMALE: metasoma with a transverse groove on 2nd sternum and a lateral incised line on 1st tergum (Key-fig. 1b); labrum mostly hidden, well removed from clypeus (Key-fig. 2b); fore femora not greatly swollen, and segments of fore tarsus long (Key-fig. 3b). MALE: antenna not crenulate in lateral profile (Key-fig. 4b)
... (p. 25) PEPSINAE, *Pepsini* .. 02

02(01) BOTH SEXES: propodeum with prominent transverse rugae (Key-fig. 5); 5th tarsal segments clearly with 2 distinct rows of regular, strong, ventral sublateral spines, the submedian spines scattered and much smaller
... (p. 25) .. *Cryptocheilus*

— Propodeum without prominent transverse rugae (e.g., Fig. 44); 5th tarsal segments usually without ventral sublateral spines, but if present, smaller than the median and submedian ones and not forming 2 distinct rows ... 03

03(02) Forewing with 2nd radiomedial cross-vein more or less vertical, never slanting more than 10° from vertical relative to wing axis (Key-fig. 6a); wings usually clear hyaline or lightly and unevenly tinted with brown (yellow in one species only); 1st segment of metasoma usually declivous above (strongly so in females), never petiolate (e.g., Fig. 38); propodeum never covered with dense, brassy pubescence; prementum of females without a fascicule of long, apically curved bristles (e.g., Fig. 13)

... (p. 29) .. *Priocnemis*

— Forewing with 2nd radiomedial cross-vein slanting more than 24° from vertical, relative to wing axis (Key-fig. 6b); wings always yellow; 1st segment of metasoma never strongly declivous above, the tergum usually evenly or gently rounded in lateral view, usually petiolate or subpetiolate (e.g., Fig. 41); propodeum sometimes covered with dense, brassy pubescence; prementum of females with a fascicule of very long, apically curved bristles (e.g., Fig. 17)

... (p. 63) .. *Sphictostethus*

LARVAE

01 Mesothorax with a raised, dorsal, shield-shaped structure bearing several sclerotised teeth or tubercles (Fig. 110); mandible with 2nd tooth widely separated from apex (Fig. 158d)
... (p. 95) .. POMPILINAE, *Epipompilini*,

Epipompilus

— Mesothorax without a raised, dorsal, shield-shaped structure bearing several sclerotised teeth or tubercles; mandible with 2nd tooth very close to apex (e.g., Fig. 152)
... (p. 25) PEPSINAE, *Pepsini* .. 02

02(01) Spiracle vertically elliptical; atrium so densely crowded with spines as to totally obscure anastomosing ridges on inner walls (Fig. 101)
... (p. 25) .. *Cryptocheilus*

— Spiracles circular; atrial spines absent or small, never obscuring atrial ridges (e.g., Fig. 102) ... 03

03(02) Head with moderately long setae, LS/OD 0.49–0.73 (e.g., Fig. 113); clypeus usually with a median impression ... (p. 29) .. *Priocnemis*

— Head with sparse, very short setae, LS/OD 0.26–0.36 (e.g., Fig. 119); clypeus without a median sulcus or impression (p. 63) .. *Sphictostethus*

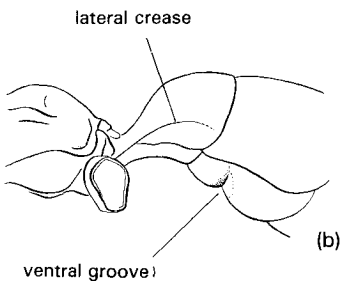
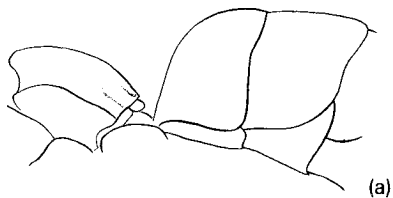

Key-fig. 1 Metasoma, lateral, ♀: (a) *Epipompilus insularis*; (b) *Sphictostethus nitidus*.

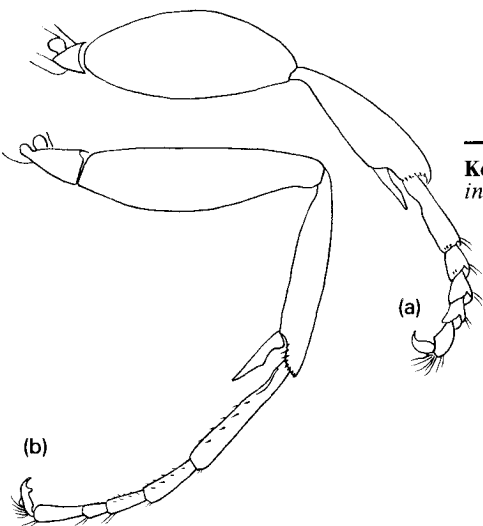

Key-fig. 3 Foreleg, ♀: (a) *Epipompilus insularis*; (b) *Sphictostethus fugax*.

Key-fig. 6 Forewing apex: (a) *Priocnemis conformis*; (b) *Sphictostethus calvus*.

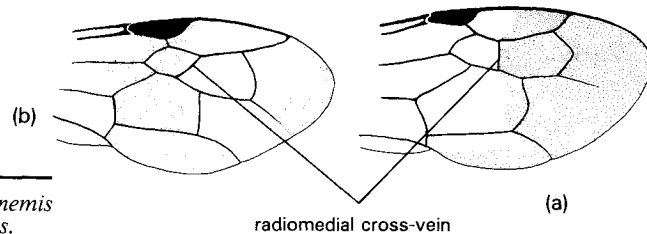

Key-fig. 4 Antenna, lateral, ♂: (a) *Epipompilus insularis*; (b) *Priocnemis nitidiventris*.

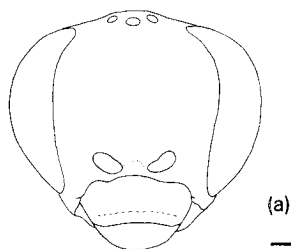
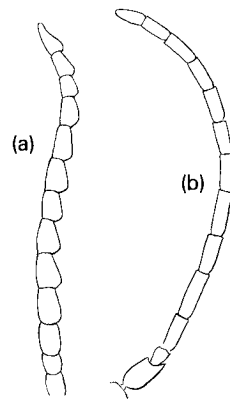

Key-fig. 2 Face, ♀: (a) *Epipompilus insularis*; (b) *Sphictostethus calvus*.

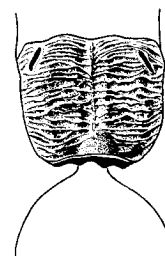
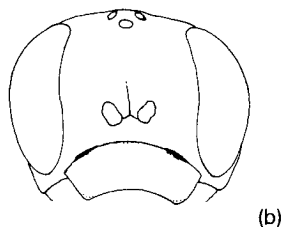

Key-fig. 5 Propodeum, dorsal, ♀, *Cryptochelilus australis*.

**KEY TO NESTING BEHAVIOUR
IN THE NEW ZEALAND POMPILIDAE**

- 01 Spider not moved, but oviposited on
in situ (Fig. 201, 202)
... (p. 95) .. *Epipompilus insularis*
— Spider moved by wasp before
oviposition ... 02
- 02(01) Spider taken to hole in tree, post, log,
or rotten log ... 03
— Spider taken to underground nest ... 04
- 03(02) Spider taken to cell in rotten log; cell
entrance not blocked with plug of
moulded mud (Fig. 197)
... (p. 76) .. *Sphictostethus calvus*
— Spider taken to vacated wood-boring
beetle gallery in standing tree or post;
cell entrance sealed with plug of
moulded mud (Fig. 198–200)
... (p. 84) .. *Sphictostethus fugax*
- 04(02) Large spider (at least size of wasp)
pushed forwards, the wasp walking
mostly forwards (Fig. 172) ... 05
— Large spider dragged backwards, the
wasp walking mostly backwards (Fig.
174) ... 06
- (NOTE: all N.Z. Pepsinae run forwards with
smaller spiders)
- 05(04) Wasp's nest in loose, shifting,
exposed sand (Fig. 184, 185)
... (p. 46) .. *Priocnemis (T.) nitidiventris*
— Wasp's nest in clay soil, never in
sand (Fig. 187)
... (p. 51) .. *Priocnemis (T.) ordishi*
- 06(04) Spider dragged prone (dorsum upper-
most), often grasped by chelicerae
(Fig. 170)
... (p. 25) .. *Cryptocheilus australis*
— Spider dragged supine (venter upper-
most), held usually by a leg base (Fig.
171) ... 07
- 07(06) Egg laid mid-dorsally on abdomen of
prey (Fig. 183)
... (p. 38) .. *Priocnemis (T.) conformis*
— Egg laid on prey laterally or ventrally,
never on mid-dorsum of abdomen
(e.g., Fig. 178) ... 08
- 08(07) Nest usually deep, generally with a
conspicuous mound of soil at

- entrance; prey mainly large mygalo-
morph spiders (Fig. 179)
... (p. 33) .. *Priocnemis (T.) monachus*
— Nest not obviously deep, usually
without a conspicuous mound of soil
at entrance; prey seldom large mygalo-
morph spiders ... 09
- 09(08) Nest seldom under stones or con-
crete; cells often well formed and
branching off an obvious main bur-
row (but sometimes single), often
branching off upper part of solitary
bee burrow (Fig. 191) ... (pp. 55, 59) ..
Priocnemis (T.) carbonarius, *P. (T.) crawi*
— Nest often under stones or concrete,
sometimes in abandoned pupal cham-
bers, etc., in soil; cells seldom
branching off an obvious main bur-
row, not numerous, not branching off
upper part of solitary bee burrow
(Fig. 194)
... (p. 66) .. *Sphictostethus nitidus*

DESCRIPTIONS

Family POMPILIDAE

Diagnosis. ADULT (both sexes). Mesopleuron divided into upper and lower halves by a single, straight, transverse groove (Figure 8). Legs long; hind tibiae extending well beyond apex of abdomen. Middle and hind legs with long, paired, apical spurs. Wings not folded longitudinally when at rest. Antennae long; scape short; flagellum (apically) gradually attenuated.

FEMALE. Antenna with 12 segments, in pinned specimens usually tightly coiled. Apex of abdomen smoothly pointed, with a retractile sting, without an obvious subgenital plate below.

MALE. Antenna with 13 segments, in pinned specimens often gently arched (usually not coiled). Apex of abdomen with a subgenital plate below.

LARVA vespoid; spiracles on 2nd segment greatly reduced.

BEHAVIOUR. Spiders exclusively used as hosts by all species. Nest cells each provisioned with a single spider only. Adults strongly heliotactic.

Remarks. Represented in New Zealand by species of the subfamilies Pepsinae (10) and Pompilinae (1). The subfamily Ceropalinae does not occur in New Zealand.

Subfamily PEPSINAE

Diagnosis. Female metasoma with a large, transverse groove on 2nd sternum and a lateral incised line on 1st tergum (Key-figure. 1b). Wing without a pocket in lower basal corner of 3rd discoidal cell. Female hind tibiae with apical, spine-like bristles (when present) of roughly uniform length, not splayed out.

Tribe Pepsini

The following diagnostic characters are in addition to those listed in the key.

ADULT. First tergum of metasoma in dorsal view with sides straight or slightly convex, never very distinctly concave, and in lateral outline with dorsum curved. Hind tibiae of female usually with a dorsal row of teeth.

LARVA. Head setae relatively short, LS/OD less than 0.80.

Genus *Cryptocheilus* Panzer

Salius Fabricius, 1804, p. 124. Type-species *Sphex sexpunctata* Fabricius, 1794, p. 457 (= *Sphex versicolor* Scopoli, 1763, p. 295), by subsequent designation (Anon. in d'Orbigny, 1848, p. 316). Junior homonym of *Salius* Schrank, 1798. Europe.

Cryptocheilus Panzer, 1806, p. 120. Type-species *Sphex annulata* Fabricius, 1798 (junior primary homonym of *Sphex annulata* Lichtenstein, 1796) (= *Pompilus comparatus* Smith, 1855, p. 134), by subsequent designation (Westwood, 1840, p. 82). Southern Europe, North Africa.

Additional synonymies are given in Day (1984, p. 89).

Diagnosis. Medium-sized to large species.

ADULT (both sexes) with clypeus comparatively large; propodeum with prominent, transverse rugae (Key-figure 5); marginal cell notably rounded at apex, not ending in a sharp, straight-sided angle (vein *Rs* distally in a wide curve); lobulus auriculate, about 0.65× as long as 1st anal vein; 5th tarsal segments in ventral aspect with 2 distinct rows of regular, strong, sublateral spines and with scattered, much smaller submedian spines. Male subgenital plate in the form of a wide, flat palette (Figure 48).

LARVA. Spiracles elliptical in outline; atrium crowded with spines which obscure the anastomosing ridges lining its internal wall. (This distinction does not apply outside New Zealand.)

Remarks. *C. australis* (Guérin), accidentally introduced from Australia in the 1960s, is the only New Zealand species of *Cryptocheilus*, which is best represented in the tropics.

Cryptocheilus australis (Guérin) new combination

australis Guérin-Ménéville, 1830, p. 260 (*Pompilus*).
Guiglia, 1948, p. 178; 1961, p. 19.
bicolor not of Fabricius, 1775, p. 352, no. 36 (*Sphex*).
Gourlay, 1964, pp. 48–49 (*Salius*). Valentine, 1967,
p. 1143 (*Salius*). Miller, 1971, p. 26, pl. 4 fig. 5
(*Salius*). [Misidentifications; see Remarks.]

ADULT

Diagnosis (both sexes). Propodeum without tubercles or denticles. Second tergum of metasoma with a very narrow, black apical band; 3rd tergum without a basal infuscation. Head of female with face and vertex fulvous yellow-orange, except for a black band as wide as ocellar triangle passing through ocelli and reaching compound eyes. Head of male with vertex and disc of frons black. Male subgenital plate and genitalia as in Figures 48 and 59.

By the foregoing characteristics this species can be distinguished from its Australian congeners. It differs from other Pompilidae in New Zealand in having prominent transverse rugae on the propodeum (Key-figure 5), the marginal cell with a notably rounded apex, and 2 rows of strong sublateral spines on the underside of the 5th tarsal segments.

Description. Female. Length 16.0–22.0 mm; forewing 13.0–17.0 mm.

COLOUR. Head with antennae, maxillary palpi, and labial palpi entirely fulvous yellow-orange. Mandibles fulvous yellow-orange, their apices infuscated. Frons, clypeus, labrum, and upper parts of genae fulvous yellow-orange. Vertex yellow-orange except for a black, transverse band about as wide as ocellar triangle passing through ocellar triangle and reaching compound eyes. Occipital region, basal parts of genae, and malar space black. Mesosoma, coxae, and trochanters black. Tegulae varying from fulvous to blackish. Legs with tibiae and tarsi fulvous; femora black basally, their apices fulvous. Wings deep yellow-orange, with a narrow apical infuscation; veins fulvous yellow-orange. Metasoma with dorsum of 1st tergum black, 2nd fulvous yellow-orange; lateral and apical margins infuscated, producing a narrow, dark dorsal band across middle of gaster; remaining terga entirely fulvous yellow-orange; venter with first 4 sterna black, 5th fulvous yellow-orange, infuscated basally, remainder yellow-orange.

VESTITURE of head and thorax so light as not to obscure surface texture of cuticle. Head and mesosoma with sparse, brassy pubescence, very sparse, brassy hairs, and a few dark hairs. Metasoma except apex with sparse, brassy hairs and very light pubescence; 6th tergum and sternum with dense golden hairs.

STRUCTURE. Head. Frons with minute punctures, these almost contiguous, and scattered larger punctures. Labrum with apical margin rectilinear. Clypeus large, 2.35× as wide as high; disc strongly gibbous, emarginate; apical margin concave. Malar space very short, 0.14× length of antennal segment 2. Front angle of ocellar triangle approximating a right angle; POL:OOL approximately 3:4. Mesosoma: dorsum with almost contiguous minute punctures. Metanotum of moderate size. Metapleura, metapostnotum, and propodeum with prominent transverse rugae, those below the pronotal declivity curved towards a median point. Propodeum without prominent denticulate tubercles lateral to the spines, there being a small, depressed tumescence — a mere raised area — only. Legs slender, spinose; metatibiae with dorsal comb-row comprising a double row of prominent scales; 5th tarsal segments ventrally with 2 distinct rows of regular, strong sublateral spines; tarsal claws dentate. Forewing venation as in Figure 21. Metasoma with very small, almost contiguous punctures and scattered large punctures; transverse groove on 2nd sternum large; lateral crease on 1st tergum distinct.

Male. Length 11.6–18.5 mm; forewing 8.0–15.0 mm.

COLOUR. Similar to female, differing mainly in having the vertex and most of the frons black. Head with vertex entirely black; frons with disc black, lateral and apical areas yellow-orange; clypeus, labrum, labial palpi, maxillary palpi, and genae yellow-orange; antennae (especially in live individuals) vivid yellow-orange; mandibles yellow-orange, apically infuscated; occipital area black. Mesosoma (except tegulae), coxae, trochanters, and bases of femora black. Tegulae varying from mostly orange to mostly black. Legs yellow-orange, except pulvillae and tarsal claws, which are dark fulvous. Wings yellow-orange, infuscated on apex, base, and anal margin. Gaster fulvous yellow-orange, except sterna 1–4 and 1st tergum, which are black; 2nd tergum mostly fulvous yellow-orange, with a narrow infuscation along its basal, lateral, and apical margins, forming a very narrow, black, transverse band midway along dorsum; 3rd tergum without basal infuscation.

VESTITURE. Body sparsely hirsute; hairs and pubescence fulvous.

STRUCTURE. Body mostly with very small, almost contiguous punctures and sparsely scattered large punctures. Clypeus relatively large, strongly and evenly gibbous, 0.5× as wide as high, apically emarginate, the apical margin rectilinear. Malar space minute, 0.03× as long as antennal segment 2. Front angle of ocellar triangle approximately a

right angle; POL:OOL approximately 1:1. Propleuron with about 8 parallel rugae. Postnotum without a median tubercle. Metapleuron and propodeum with very prominent transverse rugae (those on propodeum entirely transverse, not curved towards midline posterior to declivity); propodeum without tubercles or denticles. Femora with very small spines at apex; tibiae with larger spines at apex; 5th tarsal segments beneath with 2 distinct rows of large, sublateral spines. Forewing venation as in Figure 21; marginal cell notably rounded at apex. Subgenital plate and genitalia as in Figures 48 and 59; subgenital plate very broad and flat.

Variation. Structure, vestiture, and coloration show very limited variation. In females the width of the black, transverse band on the vertex is variable. It may be as wide as a single ocellus, in which case the area enclosed by the ocellar triangle contains some yellow pigment (e.g., on many Spirits Bay specimens), or it may be broader than the ocellar triangle, when the black area extends along a median line on the frons (e.g., on Waipoua specimens). The tegulae in both sexes vary from entirely yellow-orange to almost black, and fulvous areas occur on the humeral angles of the pronota of some Waipoua males, but the coloration of the legs and metasoma is constant in both sexes. This minor colour variation, probably related to temperature, cannot be correlated with geography on the material available.

FINAL-INSTAR LARVA

Diagnosis. Spiracles elliptical; atrium densely lined with large spines that obscure the atrial ridges. Clypeus with 20 setae; labrum with 22 setae; spinneret with 2 groups of 6 setae. (*C. australis* final-instar larvae can be distinguished from any other pompilid in New Zealand by any one of these characters.)

Description (based on a specimen, “no. 1”, from Waipoua Forest, ND, 19 Dec 1972). Length 18.3 mm; maximum width 5.5 mm.

Body (Figure 68) fusiform-cylindrical, stout, the venter unusually convex; pleural lobes weakly developed; supra-anal and suranal lobes developed equally. Anus situated in about mid segment. Ventral integument of thorax and abdomen with spinules approximately 5.2 μm long, more or less evenly spaced (Figure 80). Body setae sparse.

Spiracles vertically elliptical. First thoracic spiracle (Figure 90a,b) with greatest diameter of outer atrial rim 80.6 μm and least diameter 54.6 μm. Walls of atrium (Figure 101) lined with massive, non-branching teeth of varying shape and size, some sharp, others blunt, which completely conceal anastomosing ridges. Opening into subatrium

lined with very large, branching spines. Subatrium 80.6 μm across, immediately beneath atrium, dilating to about 90 μm , then gradually and evenly narrowing until it merges with rest of trachea. Second thoracic spiracle very reduced, proportionately much narrower than the others, obovate; rim very sharply rounded below. Atrium somewhat expanded beneath outer atrial rim, its vertical diameter at surface 40.3 μm , its greatest longitudinal diameter 16.12 μm .

Head (Figure 112) 2.7 mm wide, 2.14 mm high. Parietal bands moderately pigmented, 0.73 mm long. Antennal papilla (Figure 123) comparatively short, 41 μm long (including the 3 apical sensillae); diameter of antennal orbits 0.17 μm . Head setae sparse, the longest (on gena) 56 μm . Labrum (Figure 130) 0.73 mm wide, bearing 22 setae (the 7 mesalmost setae on each lateral lobe forming 2 rows); 18 large, pigmented sensory cones present, with 4 small additional ones on left lateral margin and 3 on right; median lobe comparatively weakly developed. Epipharynx (Figure 141a) covered with small scales and spinules, those on median lobe acicular and much larger and sharper than elsewhere (although relatively much smaller and less crowded than in *P. monachus* and *P. diligens*; a few spinules projecting beyond apical margin. Mandibles (Figure 152) 0.82 mm long, 0.56 mm wide at base, with 3 lateral setae plus a pore bearing a fine structure that projects above surface. Labium and maxillae as in Figure 159. Maxillae with lacinial area strongly and angularly produced, forming a distinct lobe; maxillary palpi 120 μm long, 61 μm wide at base, noticeably stouter than galeae, which are 114 μm long and 47 μm wide at base. Labial palpi 74 μm long; spinneret 230 μm wide, with a group of 6 setae set very close together on either side, and 2 others somewhat removed (6 spinneret setae).

Variation. Apart from overall size differences, variation in larvae examined was minor. All specimens had the same number of setae on the clypeus, labrum, mandible, and beside the spinneret on the labium. All had 18 large, pigmented sensory cones on the labrum, though these differed somewhat in arrangement, as did orientation and distribution of sensillae on the epipharynx. For instance, specimen no. 2 from Waipoua, although larger than no. 1 (labrum 0.85 mm wide, vs 0.73 mm), had only one small, pigmented sensory cone, on the left lateral lobe. The position of sensillae on the epipharynx of no. 2 also differed (Figure 141b).

Type data. **Syntypes:** 1 female, 1 male, "Port Ja[c]kson, Nouvelle-Hollande" (MCSN). Guérin-Ménéville did not designate a holotype. Guiglia

(1948, p. 178; 1961, p. 19) listed 2 syntypes (a male and a female) in MCSN, clearly the two described by Guérin (1830, p. 260). "Card labels beneath both specimens bear the legend 'Voy. Coquille. Port Jacks' without the caption 'type'" (Guiglia 1961, p. 19). Both syntypes are in a "remarkable state of preservation" (Guiglia 1948, p. 175).

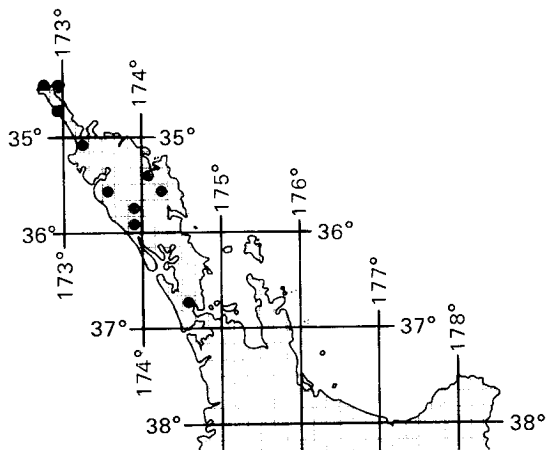

Text-fig. 2 Distribution of collection localities, *Cryptotheilus australis*.

Material examined. 300 non-type adults (134 females, 166 males) from Spirits Bay; Te Warahi Track, North Cape; Moerewa, Bay of Islands; Waitangi; Waipoua; Whangarei; and Massey, Auckland. Also 8 larvae from Spirits Bay and Waipoua Kauri Forest. Collection localities: see Text-figure 2.

ND, AK / —.

Collected from sea level to at least 120 m (east of Waipoua Forest).

Adult females and males were recorded from November to May, and were most abundant in January–March.

Biology. **HUNTING.** Searching females use vision (mostly) and antennal chemoreception. The pisaurid spider is chased until it stops and cowers, when the wasp rushes at it, stinging first the abdominal venter and then the prosomal venter (46 observations). Sometimes large spiders pursued by small wasps stop and raise themselves on the tips of their legs. The wasp examines several legs before jumping up and stinging the abdominal venter. The spider collapses, dorsum up, whereupon the wasp slowly curves its abdomen beneath the spider's prosoma and carefully stabs the prosomal venter, examines

the pedipalps, walks all over the spider, then stings it again on the prosomal venter (34 observations).

PARALYSIS is strong; host spiders do not subsequently regain movement of legs.

PREY CARRIAGE (Figure 170). The female wasp grasps the paralysed spider by the chelicerae and walks backwards, dragging it dorsum uppermost (no other New Zealand pompilid transports prey dorsum uppermost). When a female carrying prey periodically leaves the spider to inspect its nest, the spider is left exposed, dorsum uppermost, and is not taken to a place of temporary concealment. Unlike any other New Zealand pepsine, *C. australis* does not usually drag spiders into nest cells by the spinnerets.

NIDIFICATION FORMULA. Nest (= cell) – prey – egg – (cell) – closure (terminology of Evans & Eberhard 1970).

NEST (Figure 177). Of 137 nests examined, 10 were made under stones, 112 in cracks in exposed, compacted clay, 8 in unmodified clay, and 7 beside stumps, posts, etc. Where there was a main burrow it was 8.0–19.0 (16.0) mm wide; from this branched 5–17 (14) cells. Individual cells were pyriform, 25–64 (32) mm long by 17–33 (28) mm high, and connected to the main burrow by a cylindrical passage 8–15 mm, but typically around 15 mm in diameter and 20–62 (36) mm long. A complete cell and cell-passage is constructed before the female begins hunting. Host spiders are placed in the cells facing away from the cell entrance. After oviposition the female fills a 20–27 mm length of the cell-passage with compacted earth, which stops short of the spider in the cell. The main burrow and the external entrance of the nest are kept open throughout the cycle.

LIFE HISTORY (from 67 observations). The white, obovate egg, 3.5 mm long by 1.0 mm wide, is laid ventrolaterally on the host spider's abdomen (Figure 178). At around 28°C eclosion occurs after 73 hours, and after 240 hours the larva moults into the 5th instar. The entire spider is consumed after about 264 hours have elapsed; the larva then re-masticates a small mass of chewed spider chitin on its own abdominal sterna. Cocoon-spinning commences at about 300 hours, and is finished at about 334 hours. Prepupal diapause in the cocoon lasts approximately 7 months. The cocoon (Figure 203) is pyriform-obovate, terracotta-coloured, and 16–25 (18) mm long. The pupa (Figure 218) has 'handles' on the metasomal pleura and very large hind-tibial scales.

EMERGENCE AND COPULATION. Males emerge 3–8 days before females. At first 20–30 males (5–9 each from the previous season's nests) fly close to the ground, repeatedly crossing the nest area. Males

often enter nests and remove the compacted earth blocking female cell-passages. Copulation (6 observations) frequently occurs underground, sometimes between siblings. In captivity males often 'assist' emerging females, mating before they are completely free of the cocoon. A few seconds after a female has emerged from its cocoon, a male will often grab the docile female with his mandibles and pull at her wings and legs, meanwhile twisting his abdomen about. He grabs her wings and twists them while the female remains motionless. The male then clambers on top of the female, placing his forelegs on her wings and middle femora, middle legs on her hind legs, and hind legs on the ground. The tips of the abdomens then engage, and remain so for 54 seconds. The male then disengages and rapidly exits. Females begin hunting 24–50 hours after mating. Until they die, most males continue to fly in and out of the old nest and frequently interact with females carrying prey. Old nests are frequently re-used by females, but fresh cells are usually bitten out of moist clay in the walls of the (old) brood-chamber.

ADULT FEEDING. Females occasionally feed from wounds on paralysed prey (12 observations), but more usually from nectar (70). At Spirits Bay and North Cape 25 males and 14 females were observed on *Leptospermum scoparium* flowers. Between Waipoua and Dargaville males (78 observations) and females (46) were seen to feed from umbelliferous inflorescences; the sweet exudate on young seeds of parsnip (*Pastinaca sativa*) was a favoured site.

Remarks. *Cryptocheilus australis* apparently occurs only between North Cape and Auckland. Gourlay (1964) stated that B. Ashby found the first New Zealand specimen at Tokerau Beach, Doubtless Bay, on 28 April 1963. G. B. Rawlings of Kerikeri is quoted as saying that, in the same year, "*S. bicolor*" was the only species of Pompilidae to be seen in the district. However, from December 1972 to January 1973 and from November 1979 to February 1980 I found most endemic pompilid species to be abundant throughout Northland in forest. North of Te Kao *C. australis* was the only species longer than 12 mm observed in open areas, and near Spirits Bay it was very common. It did not occur in forest, e.g., on Mt Unuwahao's southern slopes, near the summit, where *Priocnemis monachus*, *P. conformis*, and *Sphictostethus fugax* were abundant.

It has been repeatedly claimed that this species is a cicada parasitoid. Although Gourlay (1964) suggested that it preyed on "funnel web spiders", Valentine (1967) thought it more probable that it

should prey on cicadas. Miller (1971) stated that its burrow resembles a mouse-hole of considerable depth with a mound of earth at the entrance, and that in Australia it fills it up with cicadas. The error arose from Froggatt (1907), who illustrated his section on Pompilidae with a nyssonine sphecid, probably *Exeirius lateritus* Shuckard, which according to McKeown (1963) is known in Australia as the 'cicada killer'. Froggatt's uncoloured drawing (p. 105, fig. 53) shows wings with sphecid venation and lacking apical infuscation, and short, sphecoid hind legs. He labelled it "*Salius bicolor*" and described it as preying on cicadas. Both species are Müllerian mimics, and examination of a large series of Australian pompilids, eumenids, sphecids, vespids, bees, etc. with notably similar coloration suggests that they belong to an extensive mimicry ring.

Froggatt's mistake was noted by Williams (1919, p. 79) and by Evans (1966) and Evans & Matthews (1973), who did not mention Williams's correction, presumably having arrived at this conclusion independently, as I did. The misidentification occurs in both directions: McKeown (1963, p. 227) stated "occasionally the large black and orange cicada killer (*Exeirius lateritus*) stocks her underground catacomb with the paralysed bodies of huntsman spiders, apparently in the absence of her customary prey, the cicada".

Evans (1959b) proposed diagnostic characters for larvae of genus *Cryptocheilus*, based entirely on Maneval's (1936) description of *C. affinis*. *C. australis* differs markedly from that species: it is not slender; it does not taper posteriorly to a slender, conical apex; the pleural lobes are unusually weak (strong in *affinis*), and the spiracles are of average size and elliptical (small and circular in *affinis*). The parietal bands are not longer than in other New Zealand Pepsinae; the labrum is not notably broad, and lacks a crenulate border on an apical emargination; and the teeth differ in no significant way from those of other New Zealand Pepsinae.

Genus *Priocnemis* Schiödte

Priocnemis Schiödte, 1837, p. 324. Type-species *Sphex exaltata* Fabricius, 1775, by subsequent designation (Westwood 1840); "Habitat in Europa".

Diagnosis. Medium-sized to small species. Related to *Cryptocheilus* Panzer, but adults readily distinguishable by having the marginal cell apically tapered and ending in a sharp, straight-sided angle towards the wing apex (apical end of vein *Rs* straight) (Key-fig. 6a); lobulus elliptical, 0.35–1.55× as long as first anal vein; propodeum without

prominent transverse ridges; 5th tarsal segments beneath without 2 distinct rows of sublateral spines; clypeus proportionately small. Larvae with spiracles circular; atrial spines small; anastomosing ridges lining internal wall of atrium clearly visible (this distinction does not apply outside New Zealand).

Remarks. The six New Zealand species referable to this genus are here placed in subgenus *Trichocurgus* Haupt **new status**. *Priocnemis* is best represented in temperate latitudes.

Subgenus *Trichocurgus* Haupt

Trichocurgus Haupt, 1937, pp. 127 and 134 (as genus). Type-species *Pompilus monachus* Smith, 1855, by original designation.

Chirodamus Haliday, 1837 (in part) per pro Townes, 1957, pp. 11 and 14 [not accepted for New Zealand species; see Remarks, below].

Diagnosis. ADULT (both sexes). Body and legs black, except in *P. (T.) conformis* (Smith), which ranges to uniformly reddish-brown. Wings hyaline or subhyaline, usually clear or lightly tinted with fuscous, but in *conformis* evenly tinted with yellow. Females with clypeus and labrum unspecialised, apically sharp and truncated; labium also unspecialised, the prementum never with a fasciculus of long, apically curved bristles. Forewing with 2nd radio-medial cross-vein more or less vertical, never slanting more than 10° from vertical relative to wing axis. Anal lobe of hind wing elliptical. Female hind tibia always with a serrated edge, the dorsal row of teeth variable in expression, ranging from a series of large, erect, sharp, scale-shaped chevrons, through somewhat reduced, slanting scales, to a series of very small, rounded tubercles. Fifth tarsal segment of females always with subapical spines below. First segment of metasoma usually declivous above (strongly so in females), never petiolate. Male genitalia with digitus volsellaris simple, its apex inwardly barbed, the distal half usually with sensillae basiconicae on outer margin. Paramere without peg setae. Male subgenital plate broadly ligulate, without a lateral, sub-depressed tubercle.

LARVA. Head with moderately long setae on vertex and temples (LS/OD 0.49–0.73); clypeus usually with a median impression; labrum with latero-apical angles very broadly rounded. Median epipharyngeal lobe with spinules sharp, acicular (except in some specimens of *P. (T.) ordishi*). Thoracic setae similar to those on vertex of head. Spiracles with spines lining subatrial ridges.

BEHAVIOUR. Prey spiders always paralysed; paralysis temporary (one species) or permanent.

Prey dragged backwards, or pushed forwards (two species). Nests single or multi-celled, always subterranean in sandy, clay, rocky, or intermediate soils. Some multi-celled subterranean nests have inner cell closures and a terminal spur. Two species make compound nests in upper parts of solitary bee burrows. Some species re-use nests over a period of several years.

NIDIFICATION FORMULA. Prey – nest – egg – closure and nest – prey – egg – closure.

Remarks. That there is a high degree of kinship among the members of this subgenus is suggested by the basic similarity of a great many shared characters; compare, for example, the male genitalia (e.g., the shape of the digitus volsellaris, its sensillae basiconicae, the parameres, the base), the male subgenital plate, the apical femoral spines of females, most aspects of the head and propodeum, and the wing venation. This resemblance is especially apparent in *monachus*, *conformis*, *nitidiventris*, and *ordishi*; *carbonarius* and *crawi* are marginally less closely related (for example, compare the male genitalia and subgenital plates with those of the other four species).

Of all the New Zealand Pompilidae, *carbonarius* most clearly resembles *Priocnemis* (*Priocnemis*) *exaltata* Fabricius of Europe, the type-species of the genus. This is reflected in the form of the marginal and submarginal cells, the extent to which the nervulus exceeds the basal vein, the form of the dorsal row of teeth on the hind tibia, and many other characters. When the subgenus is regarded in this light, *monachus* is seen to be somewhat specialised.

This view is opposite to that of Henry Townes, the last person to allude to the phylogeny of the New Zealand Pompilidae. Townes (1957, p. 11) assigned *monachus* to *Chirodamus* Halliday, stating (p. 12) that "The genus *Chirodamus* appears to be one of the most primitive of the family, as evidenced by the lack of specialisation in venation and leg bristles, and by the general scolioid habitus". He considered the *albopilosus* group to be the most primitive in *Chirodamus*, and stated (p. 14) that "The New Zealand *Pompilus monachus* Smith, 1855, seems the nearest relative of this species group". However, in *Chirodamus* Townes also placed *Sphex nitida* Fabricius (from New Zealand), which is a typical *Sphictostethus* with specialised premental bristles — indicating that he had not examined New Zealand species closely.

KEY TO SPECIES OF *PRIOCNEMIS* (SUBGENUS *TRICHOCURGUS*)

ADULTS

- 01 Antenna with 12 segments; apex of metasoma without a prominent subgenital plate below, and with a sting which may be retracted ... FEMALES .. 02
 — Antenna with 13 segments; apex of metasoma with a prominent subgenital plate below ... MALES .. 07

FEMALES

- 02(01) Wings evenly tinted with bright yellow, the apices brownish-black; body reddish-brown to black; if body black, at least some parts of legs reddish-brown ... (p. 38) .. *conformis*
 — Wings clear hyaline or variably tinted with brown, never evenly tinted with bright yellow; body and legs entirely black ... 03
- 03(02) Body, especially head and antennal scape, densely covered with long, black hairs; pubescence black, including paraoccipital patch between eye and antennal socket; hind tibia with dorsal teeth scale-like, nos 3–12 (counting from basal end) large and similar in size and shape (Fig. 32) ... (p. 33) .. *monachus*
 — Body hair relatively sparse; pubescence whitish, including that on front of head ... 04
- 04(03) Hind tibia with dorsal row of teeth scale-shaped, very well developed; malar space variously absent to moderately well developed ... 05
 — Hind tibia without well developed, dorsal scale-like teeth, instead with small, rounded tubercles; malar space always well developed ... 06
- 05(04) Ocelli relatively widely spaced (Key-fig. 7a); OOL usually less than twice POL; hind tibia with dorsal teeth scale-like, but comparatively low and narrow, and usually with a single series of small scales basally (Key-fig. 8a) ... (p. 55) .. *carbonarius*
 — Ocelli closely grouped, well separated from compound eyes (Key-fig. 7b); OOL usually more than twice as long as POL; hind tibia with dorsal teeth

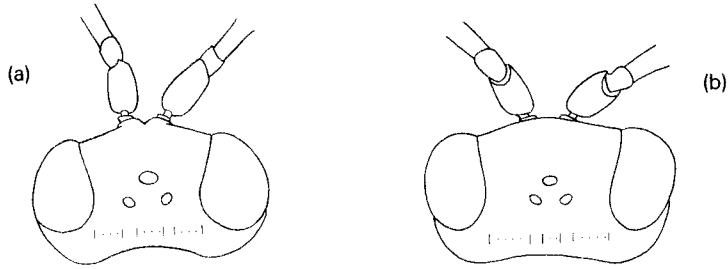

Key-fig. 7 Vertex of head, ♀: (a) *P. carbonarius*; (b) *P. crawi*.

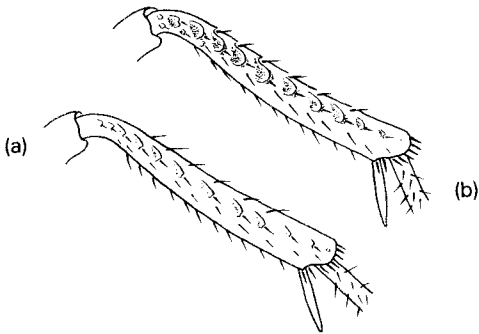

Key-fig. 8 Hind tibia, dorsal, ♀: (a) *P. carbonarius*; (b) *P. crawi*.

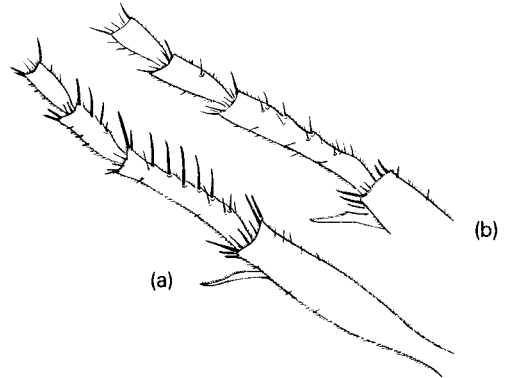

Key-fig. 9 Fore tarsus, ♀: (a) *P. nitidiventris*; (b) *P. ordishi*.

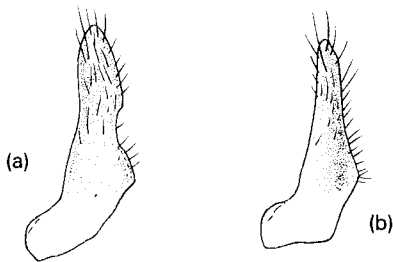

Key-fig. 10 Paramere, lateral, ♂: (a) *P. carbonarius*; (b) *P. crawi*.

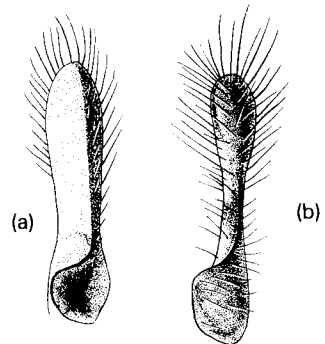

Key-fig. 11 Paramere, ventral, ♂: (a) *P. nitidiventris*; (b) *P. ordishi*.

scale-like, semilunar, very broad, usually with a double series of small scales basally (Key-fig. 8b)

... (p. 59) .. *crawi*

- 06(04) Fore tarsus with a definite comb, its first segment bearing 5 or 6 long setae (slightly longer than tarsal width) which project laterally on outer side (Key-fig. 9a); confined to sand (of beaches, dunes, rivers, and streams) ... (p. 46) .. *nitidiventris*
- Fore tarsus without a definite comb, its first segment without an obvious row of long lateral setae (Key-fig. 9b); never nesting in sand ... (p. 51) .. *ordishi*

MALES

- 07(01) Wing bases evenly tinted with bright yellow, the apices brownish-black; body uniformly black to reddish-brown, legs usually at least partly reddish-brown ... (p. 38) .. *conformis*
- Wings clear hyaline, or variably tinted with brown, never evenly tinted with bright yellow; body and legs black ... 08
- 08(07) Body hair black, dense; length of longest hairs on antennal scape at least 0.75× maximum width of scape; pubescence sparse, black; 1st tergum of metasoma steeply declivous, produced medially into a strong, compressed tubercle ... (p. 33) .. *monachus*
- Antennal scape not densely covered with long, black hairs; pubescence silvery-white; 1st metasomal tergum rounded in lateral profile ... 09
- 09(08) Apical part of subgenital plate broadly tapered, wedge-shaped or deflected downwards, without a lateral fringe of long setae (Fig. 53, 54) ... 10
- Apical part of subgenital plate not tapered, with a fringe of long setae projecting well beyond its lateral margin (Fig. 51, 52) ... 11
- 10(09) Subgenital plate long, wedge-shaped, apically rounded (Fig. 53); parameres massive in lateral view, with a semi-circular notch on ventral margin abutted on either side by prominent humps (Key-fig. 10a) ... (p. 55) .. *carbonarius*

— Subgenital plate short, squat, apically decurved, medially notched (Fig. 54); parameres in lateral profile evenly attenuated, with neither a notch nor humps below (Key-fig. 10b)

... (p. 59) .. *crawi*

- 11(09) Parameres (when not deflected outwards) with a broad, flat ventral surface, rather parallel-sided, never clavate apically; basal keel short, oblique (Key-fig. 11a). Confined to sand of beaches, dunes, streams, and rivers ... (p. 46) .. *nitidiventris*
- Detached genitalia in ventral view with parameres slender, apically clavate, without a broad, flat ventral surface, the sharp ventral ridge basally squamiform, rising to a thin, very prominent, deltoid ridge (Key-fig. 11b). Not on sand ... (p. 51) .. *ordishi*

FINAL-INSTAR LARVAE AND DIAPAUSING PREPUPAE

- 01 Labrum with 16–18 setae (e.g., Fig. 131); apex of median lobe of epipharynx with long, acicular spicules projecting well beyond labral margin (e.g., Fig. 142); anterior spiracle with subatrium greatly dilated, its maximum diameter greatly exceeding that of atrium (e.g., Fig. 91) ... 02
- Labrum with fewer than 16 setae (e.g., Fig. 134); spicules on apex of median lobe of epipharynx not projecting much beyond labral margin (e.g., Fig. 144); anterior spiracle with subatrium not greatly dilated, its maximum diameter less than 1.5× that of atrium (e.g., Fig. 96) ... 03
- 02(01) Maximum diameter of spiracular subatrium almost twice that of atrium (Fig. 91); internal atrial ridges bearing comparatively large, spicule-like spines (Fig. 102); setae closest to spinneret paired (Fig. 160). Larvae in all but the final instar on ventrolateral aspect of host spider's abdomen. Cell floor without spider-web; nest with a well formed main burrow ... (p. 33) .. *monachus*
- Maximum diameter of spiracular subatrium much less than twice that

of atrium (Fig. 92); spines on innermost ridges of atrium not appearing distinctly as spicules at $\times 200$ (Fig. 103); setae closest to spinneret single (Fig. 161). Larvae in all but the final instar transversely across dorsum of host spider's abdomen. Cell floor with a mat of spider-web; nest without a well formed main burrow

... (p. 38) *conformis*

03(01) Labrum with 12 submarginal, pigmented sensory cones; anterior spiracle with small spines (visible at $\times 200$) on all ridges lining interior of atrium ... 04

— Labrum with 10 submarginal, pigmented sensory cones; anterior spiracle with small spines only on ridges lining outer half of atrium ... 05

04(03) At least 18 setae between tentorial arms, below level of antennal orbits but well basad of setae near apical margin of clypeus; median epipharyngeal lobe with small, sharp spicules. Nest single-celled, in sand ... (p. 46) .. *nitidiventris*

— Fewer than 18 setae between tentorial arms, below level of antennal orbits and basad of setae near apical margin of clypeus; median epipharyngeal lobe with small, blunt spicules. Nest multi-celled, in soils other than sand ... (p. 51) .. *ordishi*

05(03) Mandible with 2 lateral setae; apical margin of median labral lobe evenly convex, not produced medially into a point ... (p. 55) .. *carbonarius*

— Mandible with only 1 lateral seta; apical margin of median labral lobe produced medially into a point ... (p. 59) .. *crawi*

Priocnemis (Trichocurgus) monachus (Smith) new combination

monachus Smith, 1855, p. 164 (*Pompilus*). Hutton, 1881, p. 107 (*Pompilus*); 1904, p. 97 (*Salius*). Kirby, 1881, p. 38; 1884a, p. 68 (*Priocnemis*). Waterhouse, 1883, pl. 137 (*Priocnemis*). Dalla Torre, 1897, p. 234 (*Salius*). Cameron, 1898, p. 48; 1900, p. 119; 1903, p. 297 (*Salius*). Quail, 1902, p. 256 (*Salius*). Tilliard, 1926, p. 292 (*Salius*). Haupt, 1937, p. 134 (*Trichocurgus*). Miller, 1956, p. 35; 1971 (1984) p. 26 (*Salius*). Townes, 1957, pp. 11 and 14 (*Chiro-*

damus). Gibbs & Ramsay, 1962, pp. 1–3 (*Salius*). Valentine, 1967, p. 1143 (*Salius*); 1974, p. 1234 (*Chirodamus*). Sharell, 1971, p. 182 (*Salius*). Fox, 1974, pp. 138 and 141 (*Salius*). Laing, 1978, pp. 75–78; 1979, pp. 1–21 (*Salius*).

monarchus Smith. Hutton, 1874, p. 165 [mis-spelling].
triangularis Cameron, 1898, p. 48; 1903, p. 297 (*Salius*).
Hutton, 1904, p. 97 (*Salius*). **New synonymy.**

ADULT

Diagnosis. Female. Large (length 9.0–26.0 mm). Body shining, black. Wings subhyaline, unevenly tinged with fuscous shot with mauve and blue iridescence. Veins and stigma black, opaque. Body — especially head and antennal scape — densely covered with long, black hairs. All pubescence — including paraocular patch between eye, antennal sclerite, and frontoclypeal suture — infusate. Declivity of first metasomal tergum very steep, hairy (Figure 38). Middle femur with 2 apical spines; hind femur with 4 small apical spines low on outer side. Hind tibia with a dorsal row of 12 scales, of which scales 3–12 (numbered from base) are uniformly very well developed.

Male. Large (length 9.6–19.1 mm). Body shining, black. Head, scape, mesosoma, and 1st segment of metasoma densely covered with long, black hairs. Antennal scape with some hairs at least three-quarters as long as its maximum width. Frons very shiny, without pubescence. Pubescence infusate, very sparse, mostly confined to appendages. Wings subhyaline, unevenly tinged with fuscous, shot with mauve and steel-blue iridescence. Hind ocelli bordered laterally by distinct sulci. Middle and hind femora each with 2 small, very stout apical bristles. First tergum of metasoma very steeply declivous in front, produced medially into a strong, compressed tubercle.

Description. Female. Length 9.0–26.00 mm; forewing 8.0–22.5 mm.

COLOUR AND VESTITURE. Shining, black; apical halves of mandibles and tarsal claws rufous. Wings subhyaline, unevenly tinged with fuscous (particularly near veins), shot with purple and ultramarine iridescence. Veins dark brownish-black, opaque; stigma black, opaque. Body densely covered with long, black hairs, particularly on head, antennal scape, coxae, trochanters, and femora. Mesosomal hairs dense, but shorter than the foregoing. Metasoma with dense hairs on apical 4 segments and on declivity of first tergite, more sparsely hairy elsewhere. Pubescence very fine, scattered, entirely infusate, on head confined to paraocular patches between eye, antennal sclerite, and frontoclypeal suture.

STRUCTURE. Head with labium unspecialised; submental bristles short, straight. Apical segment

of maxillary palp notably bowed. Mandibles basically unidentate, though with an incipient 2nd tooth. Malar space relatively long, $0.24-0.41\times$ as long as antennal segment 2. Clypeus unspecialised. Frons shining, with scattered large punctures at hair bases and small punctures densely interspersed. Median frontal sulcus continuous between ocellus and antennal sclerites, deep on lower half, obsolete on upper half. Front angle of ocellar triangle approximately 90° ; each hind ocellus bordered laterally by a deep sulcus; POL:OOL often about 7.5:17.2. Pronotum comparatively small, its hind margin widely angulate. Propodeum (Figure 38) without a median sulcus, its disc raised near middle, and with a prominent lateral tumescence behind spiracles. Fore femur without apical spines; middle femur usually with 2 minute peg spines apically; hind femur usually with 4 small apical spines grouped close together low on outer side. Hind tibia with a dorsal row of 12 scales, entire, all but the basal 2 uniformly very well developed (Figure 32). Tarsi with 5th segments bearing ventral bristles; claws dentate. Forewing marginal cell removed from wing-tip by about $0.8\times$ its own length; 3rd submarginal cell usually about $1.3\times$ longer than the 2nd, both cells elongate parallel to wing axis; 2nd radio-medial cross-vein vertical, straight.

Measurements: see Appendix 1, Table 2.

Male. Length 9.6–19.1 mm; forewing 8.5–17.0 mm.

COLOUR AND VESTITURE. Shining, black; apical halves of mandibles and tarsal claws rufous. Wings subhyaline, unevenly tinted with fuscous (particularly near veins), shot with iridescent mauve and steel blue. Veins dark brownish-black, opaque; stigma black, opaque. Pubescence almost confined to appendages. Body densely covered with long, black hairs, especially on frons, clypeus, genae, and antennal scape, dorsally. Dense but shorter hair covering mesosoma, coxae, and 1st segment of metasoma, especially the declivous basal half of its tergum. Pygidial hairs very dense.

STRUCTURE. Head: mandibles basically unidentate, but with an incipient 2nd tooth. Apical segment of maxillary palp notably bowed. Malar space long, about $0.24-0.41\times$ length of antennal segment 2. Frons very shining, with distinct, relatively widely spaced punctures. Front angle of ocellar triangle approximately 90° ; hind ocelli bounded laterally by a distinct sulcus; POL:OOL about 1:2. Propodeum with a longitudinal tumescence behind spiracle. Fore femur usually without apical spines; middle and hind femora usually each with 2 apical spines. Hind tibia lacking obvious teeth or scales; claws dentate. Forewing marginal cell removed from wing-tip by about half its own length; 3rd submarginal cell usually about $1.3\times$ as long as the

2nd; 2nd radio-medial cross-vein vertical, straight. First tergum of metasoma very sharply declivous, produced medially into a well developed tubercle. Subgenital plate (Figure 49) long, ligulate, subrectilinear, with long, straight bristles. Genitalia (Figure 60) simple; parameres rod-like, bearing long setae, and with a strong, transverse basal ridge. Digitus volsellaris apically narrowed, barbed inwardly, and bearing sensillae basiconicae on its outer apical 0.2. Aedeagus, parapenial lobes, and parameres extending to an approximately equal distance. Basal hooklets double.

Measurements: see Appendix 1, Table 2.

Variation. **COLOUR AND VESTITURE.** In both sexes the colour of the body and appendages is almost constant, but wing infuscation is slightly variable. Its intensity is not positively correlated with increasing latitude — in general, South Island specimens have paler wings than North Island specimens. Southern forms, however, often have fewer hairs on wing veins such as the costa, and on the stigma.

STRUCTURE. FEMALE. There is some variation in proportions. For example, some Akatarawa Saddle (WN) specimens have the penultimate maxillary palp segment shorter than the last, while in others the usual, reverse, condition obtains. The apical spines on the middle and hind femora are variable, smaller individuals frequently having fewer than three and four respectively. Old individuals often lose one or two, probably as a result of digging. **MALE.** The genitalia and subgenital plate show little variation. Frequently fewer than two apical spines on the middle and hind femora are encountered. Abrasion accounts for their absence in some specimens, but not all.

TERATOLOGICAL ABNORMALITIES. Two Trotter's Gorge (DN) females collected on 17 Jan 1973 had the following features: specimen 1 — propodeum rugose; specimen 2 — forewing with medial vein extending almost to wing margin, and an additional longitudinal vein present, running from middle of third radio-medial cross-vein towards wing margin. In another abnormality the median frontal sulcus was unusually shallow, and obsolete medially.

FINAL-INSTAR LARVA

Diagnosis. (1) Larvae large (length usually exceeding 15 mm, often exceeding 24 mm). (2) Spinneret setae paired (the 2 setae closest to the spinneret are set very close together, forming a pair on either side). (3) Spiracle with subatrium greatly dilated, very much wider than atrium in maximum (transverse) diameter. (4) Atrium with well defined, irregular spines on all the internal, anastomosing ridges, which nevertheless are clearly visible. (5)

Apex of middle lobe of epipharynx with very long, acicular spicules projecting beyond labral margin. (6) Spicules on margins of outer lobes of epipharynx comparatively small. (7) Labrum with 14 large, submarginal, pigmented sensory cones, and (8) with 17 or 18 discoidal setae. (9) Spicules projecting from lateral margins of labrum proportionately very much smaller than those of related species such as *P. conformis*.

Description (drawn from specimen no. 1 from Lee Bay, Stewart Island, 1972). Length 21 mm; maximum width 6.3 mm.

Body (Figure 69) with posterior 0.7 very swollen; pleural lobes rounded; supra-anal lobe larger than suranal lobe. Anus situated lower than midway on anal segment. Pleura and dorsum with small setae, especially on lobes and near spiracles, and on thorax. Venter and lower parts of pleura, especially near spiracles, bearing small spinules mostly about 12 μm long.

Spiracles small, round. First thoracic spiracle (Figure 91) 66 μm in diameter; internal anastomosing ridges lining atrium (Figure 102a) with distinct, sharp spines of different lengths; atrial collar almost circular, with scattered, projecting spines. Subatrium (Figure 102b) oblong-ovate in transverse section, very large and expanded, its greatest diameter (126.5 μm) greatly exceeding that of atrium, lined internally with long spines bearing 5–7 points on the swollen tips. Second thoracic spiracle (Figure 107) very reduced, circular, 33 μm in diameter; atrium without anastomosing ridges or spines; subatrium without spines, 13.6 μm wide, no wider than the reduced trachea to which it is connected, and hence almost indistinguishable.

Head as in Figure 113; width 2.37 mm, height 1.75 mm. Parietal bands 1.12 mm long, broad, deeply pigmented vandyke brown, extending on to genae beyond antennal orbits. Antennal orbits 110 μm in diameter; papilla 44 μm long. Setae sparse on vertex and upper regions of head, more numerous on genae. Longest head seta (on gena) 58.3 μm ; LS/OD 0.53. Labrum (Figure 131) 825 μm wide, with 18 discoidal setae and 13 large, subapical, pigmented sensory cones; 2 additional cone-shaped sensillae lateral to large cones, and less than half their size, on right lateral lobe. Epipharynx (Figure 142) covered with rows of spicules; median lobe bearing apically very long, acicular spicules which project well beyond margin; lateral marginal and submarginal spicules relatively small. Mandibles (see Figure 113) 48 μm long, 473 μm wide at base, with 2 lateral setae 33 μm long, and a 9- μm -long sensory filament. Labium and maxillae as in Figure 160; lacinial area of maxillae strongly, angularly produced; maxillary palp 129.8 μm long, 49.5 μm

wide at base; galeae of similar length but stouter, 124.3 μm long, 66 μm wide at base; labial palpi 55 μm long; spinneret 220 μm wide, with 2 subequal spinneret setae, their bases almost contiguous, forming a pair on either side of spinneret, the more mesal seta distinctly the longer.

Variation. Minor differences were noted in the number and arrangement of some sensillae. Some specimens had 14 large, pigmented sensory cones on the labrum. Parietal bands were much darker on specimens from Stewart Island than from elsewhere.

Type data. **Holotype** of *monachus* Smith: female, New Zealand, J. D. Hooker (BMNH, Banks Collection). Authorship of *monachus* attributed in error to White by Smith (1855); see Remarks, p. 37.

Holotype of *triangularis* Cameron: male, Grey-mouth (BR), P. Helms (BMNH, Banks Collection).

Material examined. 1026 non-type adults (531 adult females, 495 adult males) taken throughout New Zealand, from Mt Unuwhao (ND; latitude 34°26' S) to Port Pegasus (SI; 47°14' S). Also 12 final-instar larvae from Lee Bay (SI; 6), Horseshoe Bay (SI; 4), and Wainuiomata (WN; 2); all dissected. Collection localities: see Text-figure 3.

Collected from sea level to at least 2518 m (Mt Egmont summit, TK).

Adult females were recorded from November to May, and were most abundant in December–February. Adult males were recorded from November to March, and were most abundant in December and January.

Biology. **HUNTING.** Host species are frequently funnel-web and trapdoor spiders whose burrows lack lids. When hunting mygalomorph spiders (e.g., *Porrhothele antipodiana*), this wasp often enters the cylindrical webs and chases the spiders out. This also happens with *Hexathele*, and with *Cantuarina* species that make vertical, lidless burrows in soil. Fleeing *P. antipodiana* often turn to meet the pursuing wasp with the first four legs raised. They grapple. The wasp stings the spider in the abdomen, producing immediate paralysis, and then in the mid-prosomal venter. After examining the chelicerae, it stings the spider again in the prosomal venter.

PARALYSIS. Spiders do not recover from paralysis.

PREY CARRIAGE (Figure 171). *P. monachus* drags spiders venter uppermost, by a leg base, usually the coxa of the third leg, and walks backwards. When periodically the wasp inspects the nest, the spider is left exposed, venter uppermost; it is never concealed, or taken to a place of temporary storage.

When the spider is about 48 mm from the nest entrance, it is often righted and left there. The wasp enlarges the cell, then drags in the spider by its spinnerets.

NIDIFICATION FORMULA. Usually nest (= cell) - prey - egg - (cell) - closure, but also prey - nest - egg - closure.

NEST (Figure 179). To start nests, *P. monachus* digs with the apex of its abdomen, then bites at the soil and claws at it with the fore tarsi; it functions as a "puller" in the rough terminology of Olberg (1959). When nests are made in captivity against glass, females are seen to gather spoil into a lump held between the head and the forelegs. The middle legs also help hold the mass of spoil. The wasp drags itself backwards out of the burrow by means of the hind legs and the apex of the abdomen, which is curled under and dug into the ground. As the wasp forces itself backwards its abdominal apex is raised, and then reapplied to the ground. Periodically it pauses to scuffle with the fore tarsi to keep the lump of spoil together. Spoil taken out of the burrow is spread out in a flat, oval area. Stones are carried out by means of the mandibles; large stones project beyond the abdomen, and are carried back-

Text-fig. 3 Distribution of collection localities, *Priocnemis monachus*.

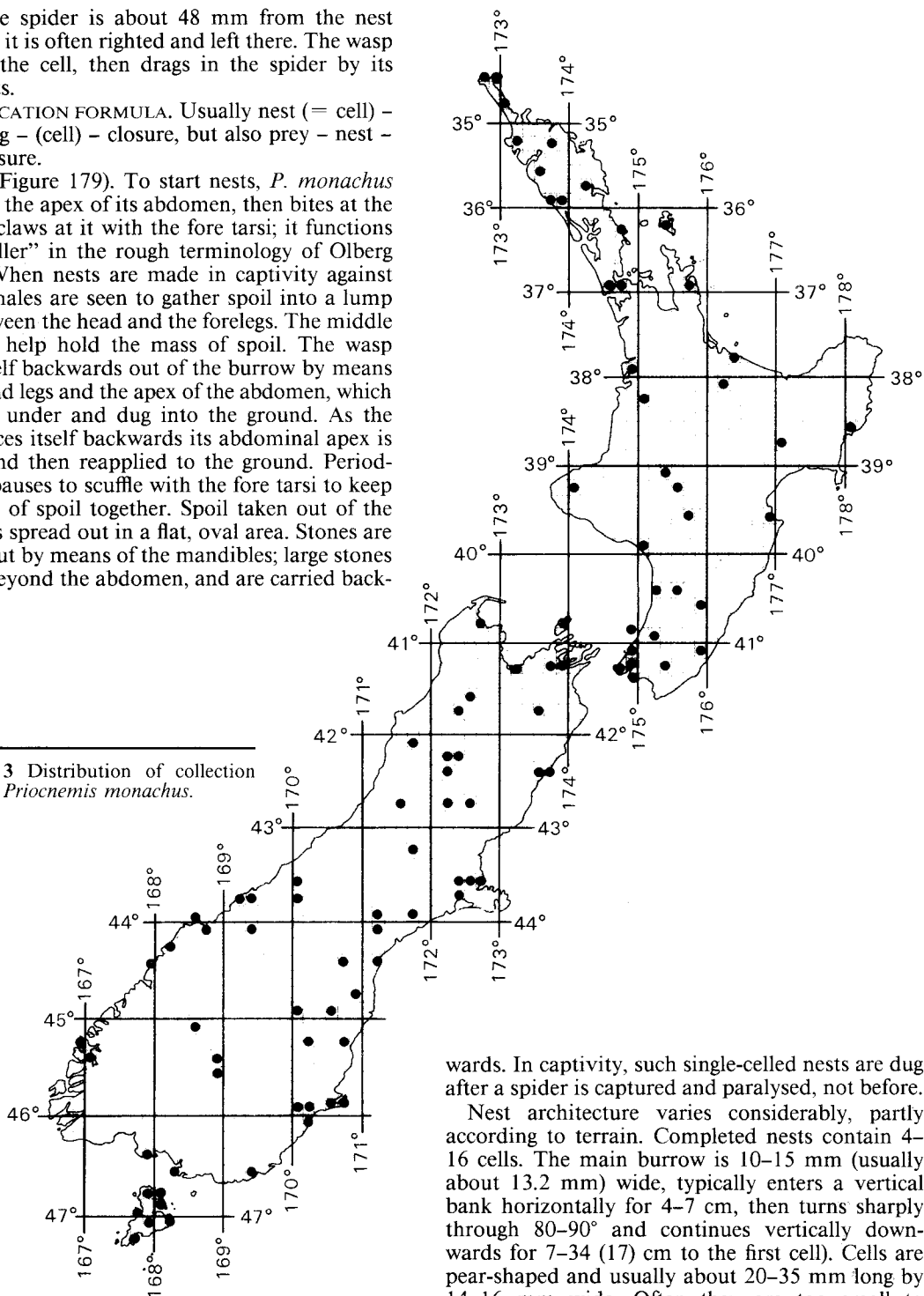

wards. In captivity, such single-celled nests are dug after a spider is captured and paralysed, not before.

Nest architecture varies considerably, partly according to terrain. Completed nests contain 4-16 cells. The main burrow is 10-15 mm (usually about 13.2 mm) wide, typically enters a vertical bank horizontally for 4-7 cm, then turns sharply through 80-90° and continues vertically downwards for 7-34 (17) cm to the first cell). Cells are pear-shaped and usually about 20-35 mm long by 14-16 mm wide. Often they are too small to accommodate the entire host spider, so that much

of the prosoma protrudes into the cell passage. The side-shafts to cells are usually almost horizontal, and 1.0–4.5 cm long. A spur is constructed before females begin hunting. Such spurs are as long as completed cells, but are not widened until after a paralysed spider is brought almost to the nest, at which time the female brings much additional spoil to the surface as the cell is widened and enlarged for the spider. Spiders are placed in the cells almost upright and facing the cell entrance. After oviposition the female fills a 9–40-mm length of cell passage with compacted earth, which completely encases the legs of the spider (these extend forwards in front of the spider along the cell-passage, sometimes almost to the main burrow), and encases as well 75% — occasionally all — of the prosoma. Old nests are frequently re-used several seasons in succession, sometimes many seasons, the old cell passages being filled in with compacted clay by the new owner. Fresh cells and side passages seem always to be made if an old main burrow is re-used. The entrance to the main burrow is left open continuously for 3–4 months, then often closed at the end of the season with a plug of compacted clay 14–17 (15) mm long. The open entrance to the nest is frequently associated with a conspicuous oval area of spoil covering 60 × 40 cm or more.

Of 379 nests located 33 (8.7%) occurred in coastal sand in foredunes 1 m above HWL; 277 (73.1%) were in clay, typically near the base of a clay bank beside a path in a partially sunny place in forest; 42 (11.1%) were between rocks or in piled rocks; and 27 (7.1%) occurred on rocky mountain crests and summits (e.g., Mt Egmont summit — 2518 m).

LIFE HISTORY. The opalescent to creamy white, obovate, slightly curved egg, 2.8–3.0 mm long by 1.1 mm wide, is laid ventrolaterally, slightly posterior to midway and almost vertically on the host's abdomen (Figure 180) (54 observations). In the field (Stewart Island, 38 specimens) eclosion occurred from 7.5 to 9 days later. After 22–23 days the larva had moulted into the fifth instar, and the entire spider had been consumed after 31–33 days. The larva then re-masticated a small mound of chewed spider chitin on its abdominal sterna for 11–26 hours before commencing cocoon spinning on the 33rd to 35th day. Prepupal diapause lasted about 7 months.

The cocoon (Figure 204) is pyriform-obovate, terracotta to burnt sienna in colour, occasionally grey-buff or olive-grey, and 17–31 (24) mm long by 6.4–9.5 (8.5) mm wide (20 cocoons). A typical cocoon measured 24.6 mm long by 8.6 mm wide at the middle. The thickness of the cocoon wall (Figure 214) divided by its width at the middle is approximately 0.01.

EMERGENCE AND COPULATION. Males emerge 3–9 days before females, and fly about the nest area. Copulation frequently occurs underground, but sometimes happens on the surface. It resembles that described for *C. australis* but is often of longer duration — pairs occasionally couple for over 5 minutes. On such occasions male and female face in opposite directions, and when the female walks the male walks backwards, making upward movements with the hind legs. Throughout their lives males fly in and out of the nest in which they pupated, shelter in it, and often die there.

ADULT FEEDING. Both sexes feed from ripe fruit and nectar: e.g., *Leptospermum scoparium* flowers — 47 males, 21 females, Tararua Range (WN); ripe drupes of *Pennantia corymbosa* — 38 males, 24 females, Tararua Range (WN), Ruahina Range (RI). Females occasionally feed from wounds on paralysed spiders (8 observations, all main islands) and from the mouthparts of prey (many observations).

Remarks. Kirby (1884b) noted that a number of New Zealand insects were “named, but not described by Adam White, which, though quoted by Walker as about to appear in the ‘Voyage of the Erebus and Terror’, were never published in that work”. That would account for Smith (1855) having attributed authorship of *monachus* to White.

Larval diagnostic characters (2), (5), and (8) distinguish *P. monachus* from *P. conformis*, to which it is similar in some respects. Spiracles of these species are superficially similar, but *monachus* has a much more expanded subatrium and proportionately much larger spines on the ridges that line the internal walls of the atrium.

The two species are easily separated in the field. *P. monachus* burrows are very large, and are often not closed at all; if they are closed, this happens only at the end of the season. *P. conformis* burrows, in contrast, are closed after each cell is completed. *P. monachus* larvae lie alongside the host spider, whereas *conformis* larvae straddle the mid-dorsum of the spider's abdomen. *P. monachus* host-spiders are immobile, owing mostly to deep paralysis but also to the fact that the prosoma is usually covered with the soil which seals the individual cells. *P. conformis* host-spiders normally recover from paralysis and move about within the cells, spinning a mat of web beneath themselves and the larva.

P. monachus is the largest endemic species of Pompilidae.

***Priocnemis (Trichocurgus) conformis* (Smith)
new combination**

conformis Smith, 1876, p. 482 (*Priocnemis*). Hutton, 1881, p. 107 (*Priocnemis*); 1904, p. 97 (*Salius*). Waterhouse, 1883, pl. 137 (*Priocnemis*). Kirby, 1881, p. 39; 1884b, p. 69 (*Priocnemis*). Dalla Torre, 1897, p. 817 (*Salius*). Cameron, 1903, p. 297 (*Salius*). Gourlay, 1927, p. 692 (*Salius*).

diligens Smith, 1876, p. 483, pl. IV fig. 3 (*Priocnemis*). Kirby, 1881, p. 38; 1884b, p. 68 (*Priocnemis*). Hutton, 1881, p. 108 (*Priocnemis*); 1904, p. 97 (*Salius*). Dalla Torre, 1897, p. 219 (*Salius*). Cameron, 1903, p. 297 (*Salius*). Tillyard, 1926, p. 292 (*Salius*). **New synonymy.**

marginatus Smith, 1876, p. 483, pl. IV fig. 2 (*Priocnemis*). Kirby, 1881, p. 39; 1884b, p. 68 (*Priocnemis*). Hutton, 1881, p. 108 (*Priocnemis*); 1904, p. 97 (*Salius*). Dalla Torre, 1897, p. 281 (*Salius*). Cameron, 1898, p. 47; 1903, p. 297 (*Salius*). Tillyard, 1926, p. 292 (*Salius*). **New synonymy.**

ADULT

Diagnosis. Female. Wings subhyaline, tinted with yellow. Head with vertex, frons, and genae black. Fifth tarsal segments black. Colour of metasoma variable: reddish above latitude 43°42'S, black below 45°30'S, and between these latitudes black, reddish, or diversely banded or spotted with reddish and black. Reddish specimens with bronzy-gold pubescence on head, thorax, and propodeum. Mentum unspecialised, with short, erect bristles. Hind tibia relatively smooth; setae reduced in size and number, the dorsal comb row reduced to a series of very small, obtuse, rounded swellings. Middle and hind femora with 3 minute, peg-like apical spines. First tergum of metasoma (Figure 39) with a very steep, hairy basal declivity. (See also Remarks, p. 45.)

Male. Coloration variable; wings subhyaline, yellow-tinted; metasoma castaneo-rufous above latitude 43°42'S, black below latitude 45°30'S, and between these latitudes black, reddish, or diversely banded or spotted with red or black. Entire body and legs and most of wings black in some southern forms. First segment of metasoma short, not petiolate, its tergum with a steep basal declivity. All metasomal sterna without carinae or other raised structures. Genitalia with the parameres sinuous when viewed from below.

Description. Female. Length 7.5–19.0 mm; forewing 6.5–14.6 mm.

COLOUR AND VESTITURE. Head with clypeus and mandible (except apex) red or black; antennal scape reddish-brown or black, flagellum brownish-black; palpi fulvous or black; remainder of head black. Legs mostly reddish-brown, mostly black, or variously marked with black and reddish-brown; 5th tarsal segments black. Wings subhyaline, tinted with

yellow; forewing apical infuscation dark, of variable width; stigma very variable; veins amber, infuscated on apical part of wing. Mesosoma and metasoma red, black, or variously patterned with reddish-brown and black. Head (including clypeus and basal third of mandibles), pronotum, mesepisternum, metapleuron, and propodeum densely pubescent, the hairs bronzy-gold on all reddish specimens and infuscate on most black ones. Head (clypeus, frons, vertex, genae), mesosoma, and coxae with moderately long, erect, fuscous hairs. Metasoma with apical hair-tuft confined to last 2 segments.

STRUCTURE. Head with labrum unspecialised, bearing short, erect bristles on prementum. Malar space moderately long, about 0.16–0.25× as long as antennal segment 2. Mandible partially bidentate, the incipient 2nd tooth usually better developed than in other New Zealand Pepsinae. Frons with a median swelling extending to the somewhat elevated antennal sclerites. Median frontal sulcus continuous between antennal sclerites and anterior ocellus, deeply incised throughout. Head and mesosoma pitted with small, contiguous punctures. Pronotum short. Propodeum (Figure 39) uneven; midline furrowed on disc, carinate posteriorly; discolateral tumescence obtuse, extending from above inner side of spiracle almost to posterior rim of propodeum. Fore femur without apical spines; middle and hind femora each usually with 3 small, stout, peg-like spines surrounded by hairs and grouped in a triangle very low on outer side at apex. Hind tibia without teeth but with small, rounded swellings at base of dorsal setae (Figure 33). Fifth tarsal segments with weak ventral spines, 3 medially and 2 near sides; claws dentate. Forewing: stigma very small, about 0.4–0.5× as long as marginal cell, which is removed from wing-tip by about 0.61–0.91× its own length. First tergum of metasoma with a very steep basal declivity.

Measurements: see Appendix 1, Table 2.

Male. Length 5.0–14.0 mm; forewing 6.5–14.6 mm.

COLOUR AND VESTITURE. Head with apex of clypeus, mandible except base, first 2 antennal segments, and palpi reddish-castaneous or black. Mesosoma with tegulae and anterolateral margin of pronotum castaneous or black; head, thorax, and propodeum otherwise black. Legs with bases of coxae and 5th tarsal segments brownish or black, remainder reddish-brown or black. Metasoma except apex reddish-brown or black. Head, mesosoma except metapostnotum, and coxae with dense, decumbent pubescence; metasoma with finer, sparser pubescence; hairs bronzy-gold on reddish specimens and usually dark on melanics (cf.

Sphictostethus calvus and *S. fugax*, on which it is golden). Head with many long, erect, fuscous setae; setae shorter, finer, and more sparse on mesosoma, and finer though fairly dense on basal declivity of 1st tergum of metasoma. Wings subhyaline, tinted with yellow; at least apical third of forewing infuscated; stigma variable.

STRUCTURE. Head with malar space about 0.16–0.25× as long as antennal segment 2. Median frontal sulcus shallow, entire from antennal sclerites to median ocellus. Front angle of ocellar triangle slightly less than 90°; POL:OOL about 1:2. Head and mesosoma with small, contiguous punctures. Pronotum moderately short. Metapostnotum comparatively wide, sloping evenly, without a median sulcus. Propodeum with discolateral tumescence obtuse, slanting obliquely mesad above and behind spiracle. Femora without spines; tibiae with apical spines; hind tibiae smooth. Claws dentate. Forewing with stigma moderately short. First segment of metasoma short, not petiolate, its tergum with a very steep basal declivity. Metasomal sternites smooth, without carinae or projections. Subgenital plate broadly ligulate, apically truncated, its bristles of moderate length (Figure 50a,b). Genitalia (Figure 61a,b) with all valves of similar length. Parameres sinuous in ventral view.

Measurements: see Appendix 1, Table 2.

Variation (Text-figure 4). **COLOUR AND VESTITURE.** The forewing stigma may be very pale testaceous and semi-translucent, fulvous and semi-translucent, opaque black, or intermediate between any of these. There is no direct relationship between stigmal coloration and the extent of wing infuscation, and all variants occur on both red-bodied specimens and melanics. The apical infuscation too is variable, the size of the infuscated area showing a clear general correlation with increasing latitude. Nevertheless, most samples of over 30 specimens from south of Auckland contain some individuals with the infuscation terminating well above the level of the stigma, and others in which it extends basad of it. In Northland specimens the infuscation is often confined to the extreme apex, although in some from Spirits Bay it extends almost to the stigma. No two individuals are alike, even in a sample of 45 specimens taken in an area of 50 square metres. Notwithstanding this, a collection from an area of that size will be readily distinguishable from a similar collection taken a few kilometres away — for example, individuals in Wellington samples from Wainui Ridge, Karori, and Akatarawa Saddle are distinguishable.

Very distinctive and highly localised forms occur frequently. For example, out of 22 females taken at Trotter's Gorge (45°24'S) on 17 Jan 1973, 18

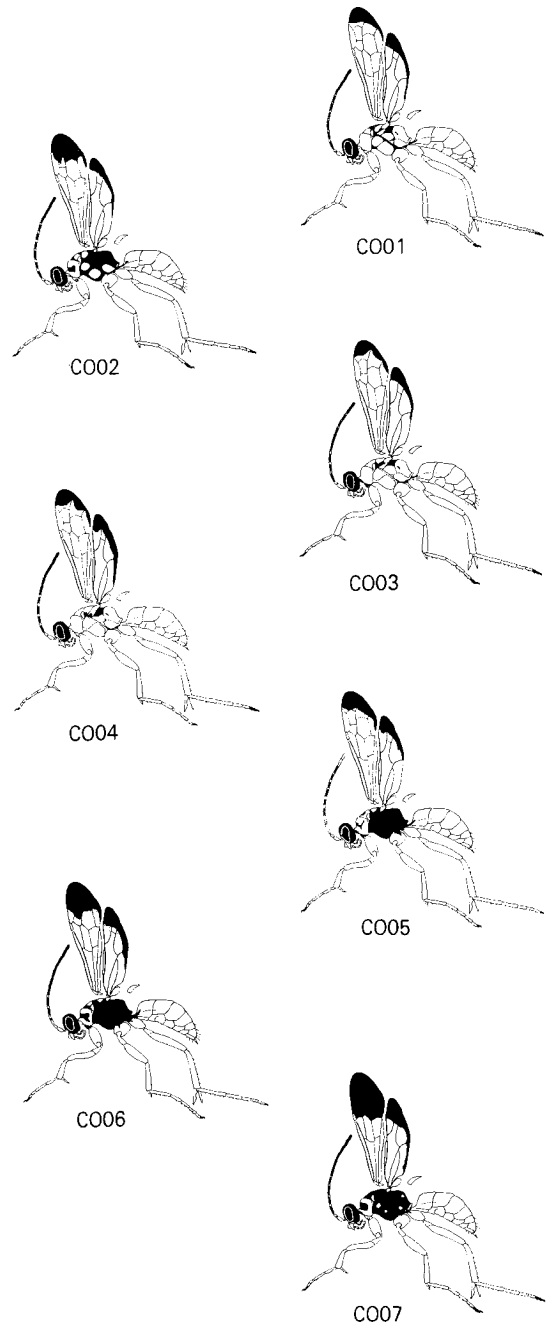

Text-fig. 4 (part) Selected, locally representative females of *Prionemism conformis*; see map on p. 42

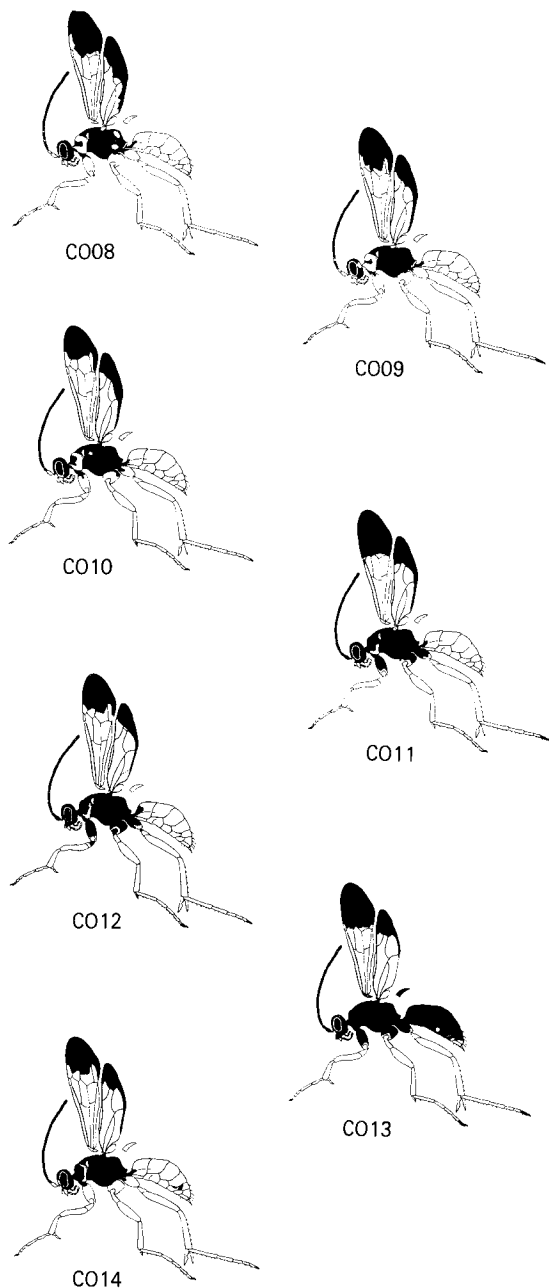

Text-fig. 4 (part) Selected, locally representative females of *Priocnemis conformis*; see map on p. 42

had more than twice the usual amount of infuscation. This had a distinctive pattern; infuscation covered the entire costal cell, the medial cell, and all cells with bases distal to the median cell's base, and extended along the subcostal margin of the radial cell to its base. I have seen but a single specimen of this form outside Trotter's Gorge, in a sample from Hook Bush (44°39'S), out of a total of 134 wasps from Hook Bush and Kelsey's Bush, Waimate. (Trotter's Gorge and Waimate are about 80 km apart in a direct line.)

Another highly distinctive form occurs in southern Southland. Twenty specimens from Colac Bay (46°22'S) and Waipati River mouth (46°37'S) have a distinct fascia across the wing at the level of the cubito-anal vein, resulting from infuscation of both the membrane and the wing setae. It is variable, and in some specimens the wing membrane at the site of the fascia is incompletely infuscated.

The apical infuscation of the forewing is proportionately larger in North Island males than in females. In some Stewart Island specimens the infuscation extends almost to the base of the wing, and a few even have both pairs of wings entirely dark. Nevertheless, the characteristic wing types of distinctive local forms — such as those from Trotter's Gorge and Colac Bay / Waipati River — are common to both sexes.

In females the head is always black — with the exception of the clypeus, which is at least partly red, and the mandibles, which are castaneous and infuscated apically — on all North Island specimens examined. The antennal flagellum is black, and the scape and pedicel are castaneous, on all North Island females. All fifth tarsal segments are invariably infuscated throughout New Zealand. Below the latitude of Auckland, the propodeum is black. Although the mesosoma is typically black, the thorax can have small reddish areas on it as far south as Christchurch. The mesosoma of Northland specimens is typically variegated, with usually a majority of areas black, and the remainder rufo-castaneous. A specimen typical of the sample from Spirits Bay (34°27'S) has the head, thorax, and propodeum black except for the clypeus, posterior pronotal disc, and pronotal tubercle, which are reddish.

The largest and most enigmatic range of variation within small populations occurs between latitudes 43°45'S and 45°30'S, east of the main divide of the Southern Alps. There, a typical sample will often consist mostly of reddish and blackish specimens in roughly equal numbers, and a very small number of intermediates. Small pockets of mostly black and mostly reddish wasps occur as well. The black form has the head and all its appendages, the mesosoma, coxae, trochanters, and metasoma

black. Pubescence is sparse, and is always completely infuscate. The 'red' form has the metasoma, trochanters, and most of the coxae reddish. Patches of fulvous red occur on the antennal scape, the clypeus, and the thorax, while the pubescence is bronzy-aeueous. The infrequent intermediate forms have the metasoma banded or spotted with black and reddish in a great variety of ways, and the pygidium sometimes castaneo-rufous. The pubescence may be bronzy-aeueous or black. The general pattern there suggests secondary intergradation following disruption of part of a cline; this impression is quite striking when my 5544 specimens (males and females) are viewed, arranged latitudinally in a series of 22 store boxes. (The situation is discussed more fully under 'Parallel ecophenotypic colour variation' in Harris 1974). South of latitude 45°30'S all females lack both reddish pigment and bronzy-aeueous pubescence. The proportion of black on the legs increases with latitude, so that Colac Bay and Stewart Island specimens typically have the femora mostly black.

In the male, changes in body colour parallel those of the female, although males tend to be darker. Thus, the apical four segments of the metasoma may be black even in Spirits Bay specimens, while in others those segments are rufo-castaneous. Below latitude 43°45'S all males have at least the apical four segments of the metasoma infuscate. Many Stewart Island specimens have the entire body, legs, and appendages black.

STRUCTURAL VARIATION. In females the apical spines on the middle and hind femora vary in number from 0 to 3. The presence of fewer than 3 can usually be ascribed to abrasion.

In males the median frontal sulcus is variable. In Pureora (TO) specimens it is deep medially, but becomes obsolete and vanishes well above the antennal sclerites. In those from Spirits Bay (ND) it is obsolete medially and resumes just apical of midway as a very distinct, narrow scratch between the antennal sclerites. Nelson (NN) specimens are similar, save that the frontal area carrying the groove is raised just below midway. On specimens from Stewart Island (SI) the median sulcus is continuous but becomes fine medially, where it crosses a small, very rounded tumescence. Specimens from The Remarkables (CO) are similar, except that the depressed tubercle is smaller and situated lower on the face, at 0.63 from the ocellus. The frons is gibbous on the ocellar 0.6 of its length. In Beaumont (CO-SL) specimens the continuous sulcus is surrounded on either side by frontal swellings.

As in *P. monachus*, the maxillary palp becomes regularly shorter with increasing latitude. This may indicate a reduction in surface area in relation to decreasing mean annual temperature. The ratios

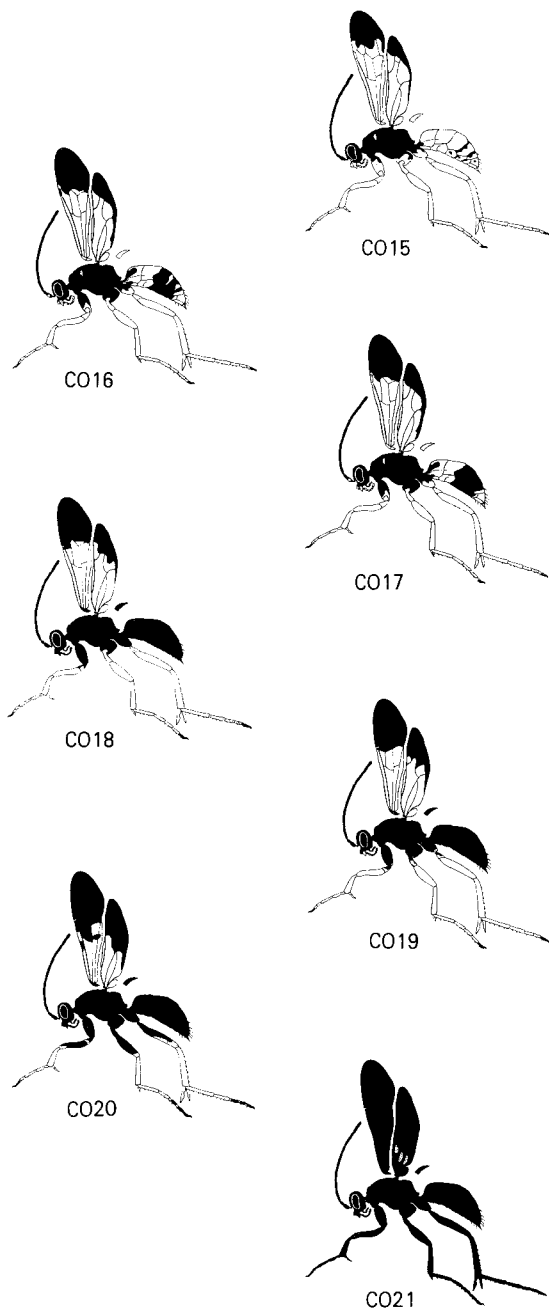

Text-fig. 4 (part) Selected, locally representative females of *Priocnemis conformis*; see map on p. 42

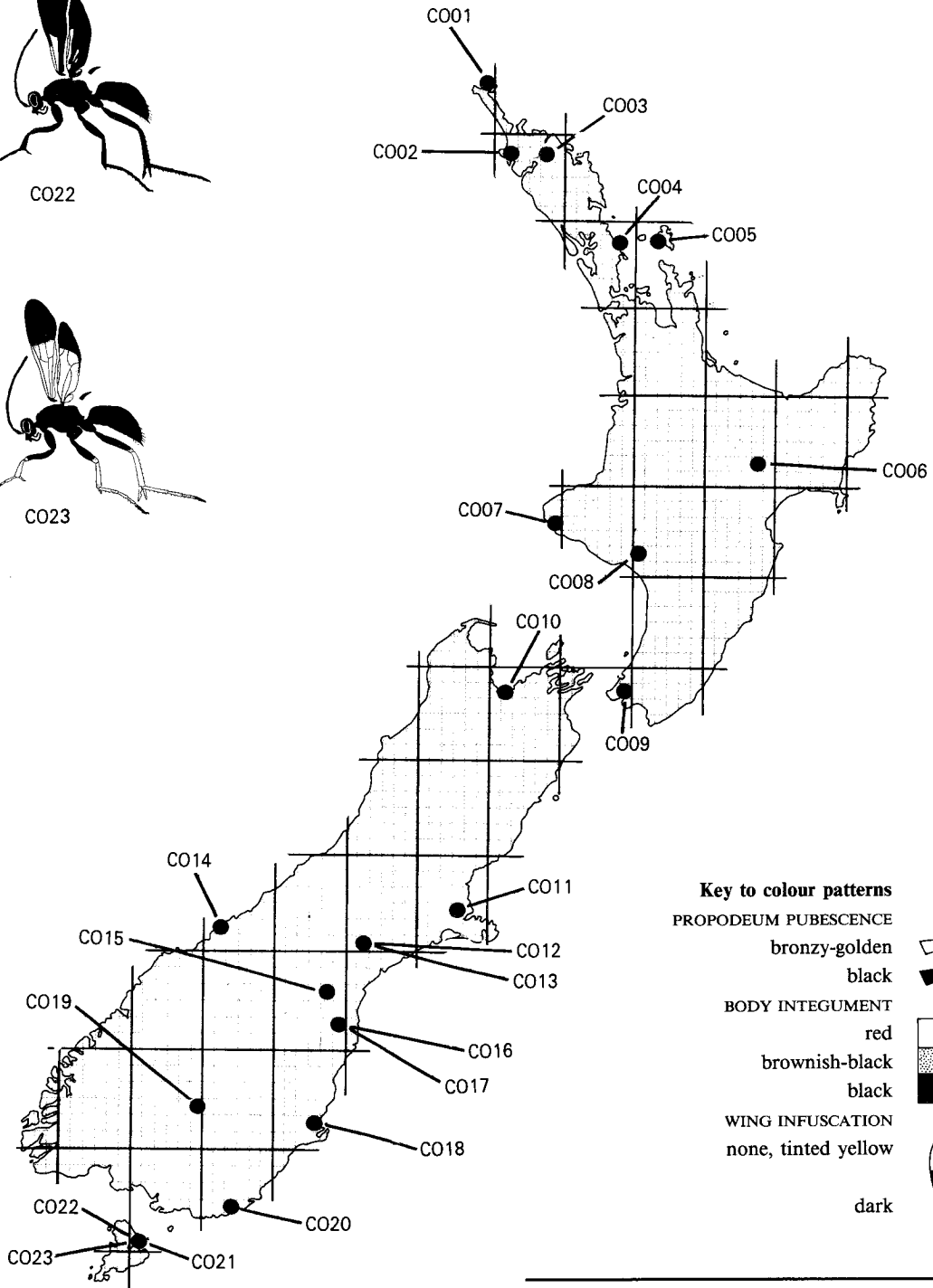
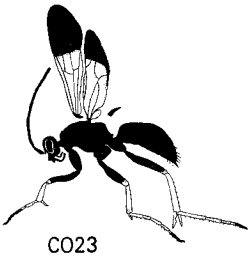
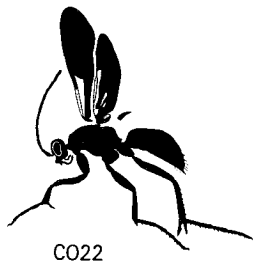

Key to colour patterns

PROPODEUM PUBESCENCE

bronzy-golden

black

BODY INTEGUMENT

red

brownish-black

black

WING INFUSCATION

none, tinted yellow

dark



Text-fig. 4 (part) Selected, locally representative females of *Priocnemis conformis* and their place of origin.

TFD:FD and MID:TFD also decrease southwards in a regular manner.

TERATOLOGICAL ABNORMALITY. A female from Cashmere, Christchurch (MC) has an additional longitudinal vein projecting into the third submarginal cell from the middle of the third radiomedial cross-vein.

FINAL-INSTAR LARVA

Diagnosis. Head with setae of vertex and temples moderately long — longest head seta about 57 μm ; LS/OD 0.65–0.73. Labrum with 16–18 setae and 12–14 large, submarginal pigmented sensory cones; apical margin of median lobe very convex. Epipharynx: meso-apical area with long, regularly arranged, sharply acicular spinules projecting well beyond apical margin. First thoracic spiracle with distinct spines on all internal ridges of atrium, those on innermost ridges weak; maximum transverse diameter of subatrium much greater than that of atrium.

The first four instars of the ground-dwelling larva are unusual in their position transversely across the dorsal surface of the host's abdomen. This, and the fact that the spider recovers from paralysis and moves around the cell, spinning a mat of web which persists after the spider has been devoured, sometimes assists field identification.

Description (based on a specimen from Piano Flat, SL, Mar 1972). Length 11 mm; maximum width 3.3 mm.

Body (Figure 70) much swollen posteriorly; pleural lobes small; supra-anal lobe much larger than suranal lobe; anus situated lower than midway on anal segment. Prothorax dorsally with small setae 28–48 μm long. Venter with short spinules, 10 μm wide at base and 6 μm high, closely and regularly arranged anteriorly and pleuroventrally, sparsely scattered elsewhere (Figure 81).

Spiracles pale yellow, round. First thoracic spiracle (Figure 92) 54 μm in diameter. Internal ridges of atrium (Figure 103) with distinct spines, those on innermost ridges weak. Atrial cells enclosed by anastomosing ridges, large, elongate, more or less even. Atrial collar ovoid, 29 μm in maximum diameter, unevenly lined with spines; collar spines variable — some long (6 μm) and apically truncate or bifurcate, others smaller and acicular. Subatrium ovoid to oblong-ovate in cross-section, its walls thrown into 7 or 8 rows of folds; folded distal region lined internally with large, grouped spines. Greatest diameter of subatrium clearly exceeding that of atrium; lumen proximally beyond folds constricting evenly to much smaller diameter of remainder of trachea.

Head (Figure 114): maximum width 1.28 mm; height (excluding labrum) 1.0 mm; HW/HH 1.28 mm. Face with a somewhat rectangular outline; 4 shallow depressions transversely between parietal bands above level of antennal orbits. Parietal bands moderately short, comparatively broad, yellow, weakly pigmented, 429 μm long, not extending beyond lower level of antennal orbits. Antennal papillae (Figure 124) 34.7 μm long (excluding the 3 apical sensillae), 0.44 \times maximum diameter of antennal orbits (78 μm). Setae of vertex and temples relatively slightly longer than in other species (except *E. insularis*); longest head seta 57 μm ; LS/OD 0.73. Clypeus with a shallow median impression and 6 setae arranged in evenly spaced rows of 3 on either side. Labrum (Figure 132) 493 μm wide, 193 μm in median height, with 18 setae and 12 large, submarginal pigmented sensory cones. Lateral lobes well separated medially, their outer apical angles very broadly rounded. Median lobe very sharply convex; projecting aciculate spicules of meso-apical area of epipharynx visible beyond apical margin of median labral lobe. Apical margins of lateral lobes markedly spinulose. Epipharynx (Figure 143) covered mesally with long, acicular spicules, very evenly arranged, which become finer, longer, and sharper towards apex and project well beyond it. Mandibles (Figure 153) with 2 apical teeth and 2 lateral setae, 561 μm long by 416 μm in maximum width; ML/MW 1.35. Labium and maxillae (Figure 161): lacinial area of maxillae angularly produced; maxillary palpi 85 μm long, 51 μm wide at base; galeae 80 μm long, 38 μm wide at base; labial palpi 50 μm long, 34 μm wide at base; spinneret 187 μm wide; 1 or 2 spinneret setae present.

Variation. Parietal bands pale yellow in most specimens. All Stewart Island specimens (9 from Lee Bay) with parietal bands stained strongly Vandyke brown, and with a weak, wide area of pigment extending beyond lower level of antennal orbits. Longest head seta 60 μm in 3 Stewart Island specimens of 9, 10, and 10.5 mm long total length; diameter of antennal orbits totalling 95 μm ; LS/OD 0.65. Slight differences in positions of setae on maxillae and labium apparent in 1 Stewart Island specimen.

Type data. **Holotype** female and **allotype** of *conformis* Smith: Peel Forest (SC), C.M. Wakefield (BMNH, Banks Collection). **Holotype** of *diligens* Smith: female, Peel Forest (SC), C.M. Wakefield (BMNH, Banks Collection). **Holotype female** and **allotype** of *marginatus* Smith: West Coast, South Island (WD), C.M. Wakefield (BMNH, Banks Collection).

Material examined. 4719 non-type adults (2550 females, 2169 males) from all coded collection areas between Mt Unuwaho (latitude 34°26'S) and southern Stewart Island (47°15'S). Also 43 larvae; dissected larvae from Renata Hut, Tararua Range (WN), Piano Flat and Tautuku (SL), and Lee Bay (SI). Collection localities: see Text-figure 5.

Collected from sea level to at least 1829 m (The Remarkables, CO).

Adult females were recorded from October to May, and were most abundant from December to March. Adult males were also present from October to May, but were most abundant in December and January only.

Biology. HUNTING. Immature and smaller mygalomorph species (females) are often hunted, usually on the ground. *Cantuarina* species, which construct vertical, lidless burrows, are chased out of their burrows before being stung, or are paralysed underground, dragged out the burrow, and interred elsewhere.

PARALYSIS of spiders is temporary. The host spider recovers from paralysis after 3–14 hours, and is then capable of almost normal movement. It

Text-fig. 5 Distribution of collection localities, *Priocnemis conformis*.

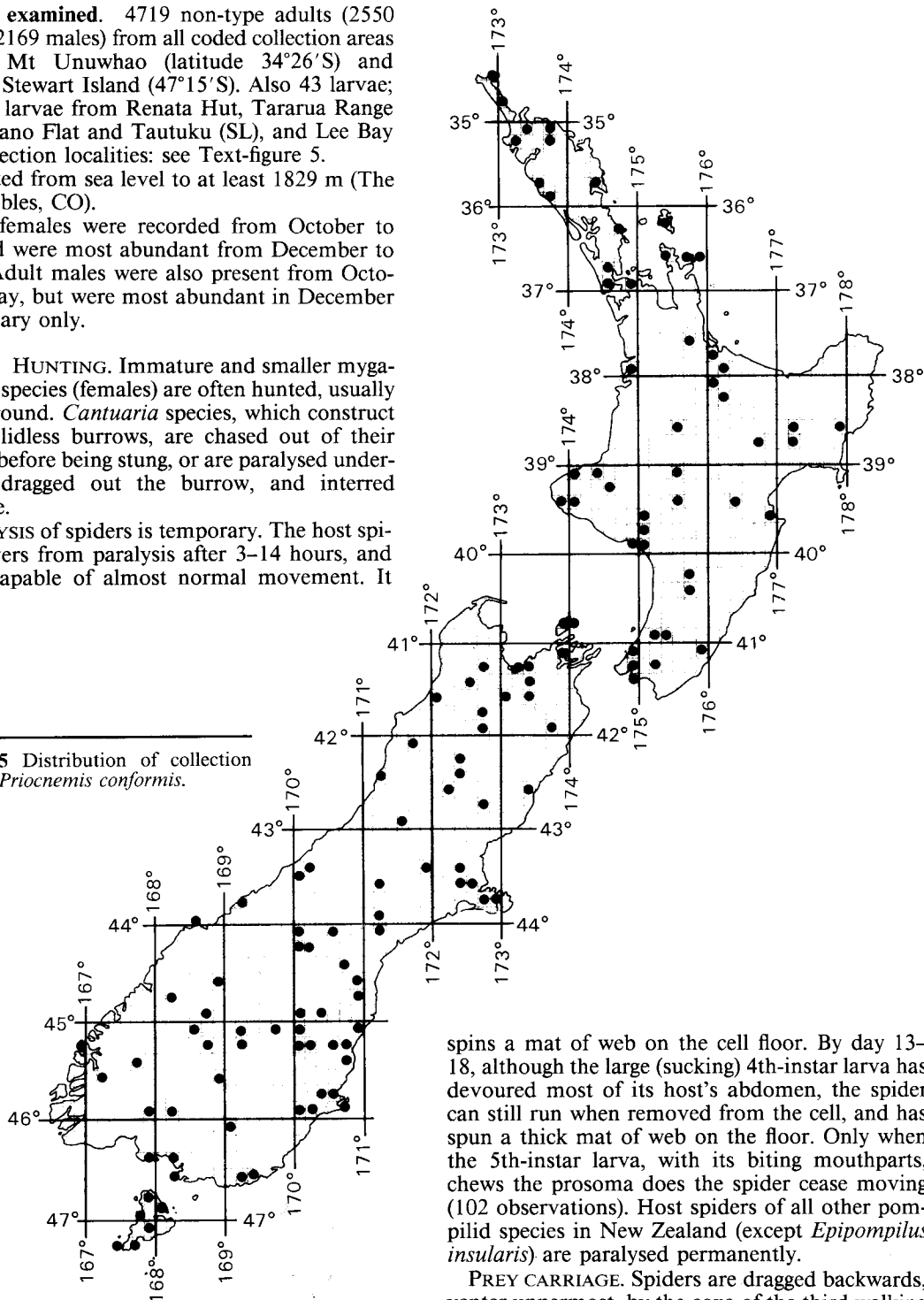

spins a mat of web on the cell floor. By day 13–18, although the large (sucking) 4th-instar larva has devoured most of its host's abdomen, the spider can still run when removed from the cell, and has spun a thick mat of web on the floor. Only when the 5th-instar larva, with its biting mouthparts, chews the prosoma does the spider cease moving (102 observations). Host spiders of all other pompid species in New Zealand (except *Epipompilus insularis*) are paralysed permanently.

PREY CARRIAGE. Spiders are dragged backwards, venter uppermost, by the coxa of the third walking leg. After paralysis sets in, the wasp examines the

spider for 10–18 minutes, appearing to feed from its mouthparts. Spiders are usually hidden (e.g., pushed under a log or twig, or between a leaf a twig) while a nest is dug. The wasp returns to the spider, drags it venter-up by a third coxa to within 25 mm of the nest entrance, leaves it to examine the cell, then drags it in by a spinneret.

NIDIFICATION FORMULA. Usually prey – nest – egg – closure; occasionally nest – prey – egg – (cell) – closure.

NEST (Figure 181). Sites range from high water spring tide level to at least 2600 m, and include coastal sand-dunes, forest margins, open forest, snow tussock, and bare paddocks. A sunny, north-west-facing bank in native forest will often contain many nests.

As it digs the nest, *conformis* periodically breaks away to dig 3–9 (usually 4 or 5) additional burrows, or false nests, which are often arranged in an arc about the true nest (Figure 182).

Of 231 nests examined, 208 were single-celled, 7 were 2-celled, and 14 had 3–10 cells; 164 were in loose, friable humus in dry, sunny places, 28 were in sand, and 39 were in pre-existing cavities, e.g., abandoned cicada burrows in clay. (Many shallow ‘multi-celled’ nests in friable soil may really have been single-celled nests closely grouped, each with an independent surface connection.)

Seven nests in abandoned cicada burrows extended horizontally in vertical banks for 25–39 cm, were 5–9 mm wide, and were filled to the surface with berries, small leaves, soil, etc. Twenty-three nests dug by *conformis* in friable earth sloped at 75–88° to a depth of 22–27 (25) mm. The passage, approximately 10 mm long by 3–9 mm wide, opened out to a 6–14-mm-wide cell.

Host spiders were orientated upright, as though naturally occurring on the surface, dorsum uppermost but with the legs brought in. (Other New Zealand Pepsinae position spiders venter-up, or on the side.) Spiders often moved, and spun mats of web on the floor of the cell. The mat of spun web, the manner of cell closure, the single-celled nests, and the position of the egg and early larva readily distinguish *conformis* nests.

Nests are not left open, but are almost always filled right to the surface 1–6 hours after oviposition with clumps of earth, twigs, berries, small leaves, and other fragments, carried in the mandibles and rammed into place with the apex of the abdomen.

The nest entrance is always disguised. Small leaves, berries, twigs, and particles of earth are dropped over the nest entrance, and other pieces are dragged away. Fragments are gathered from up to 40 cm away from the nest and dropped anywhere within a 30-cm radius from the entrance.

Larger leaves are pulled around also to further disguise the nest. Periodically the wasp breaks off to ‘disguise’ 3–9 further sites that (my examination has revealed) are not nests.

This species frequently engages in ‘appetitive’ digging outside the nidification cycle. Both sexes also dig ‘sleeping burrows’ sometimes.

LIFE HISTORY. The white, oblong-ovate, slightly curved egg, 1.86–2.00 mm long by 0.80 mm wide, is laid mid-dorsally across the host’s opisthosoma, the head end inclined slightly to one side (Figure 183). After moulting into instar 5 (day 13–18) the larva begins biting and chewing in the usual way, and comes to lie with its abdomen beneath the host’s prosoma. Feeding stops on day 15–22, depending on ambient temperature. Cocoon-spinning, begun on day 16–23, finishes on day 17–24 (102 observations).

Thirty-four cocoons (Figure 205) were sub-pyriiform, rigid, truncate at the narrow (meconial) end, 8–27 mm long, and burnt sienna to cinnamon-brown in colour. The thickness of the cocoon wall divided by its width at the middle was 0.01.

EMERGENCE AND COPULATION. Males emerge 4–10 days before females. Copulation frequently occurs above ground, often far from nests, typically in a sunny place, on the ground or on low vegetation. After facing the female, antennae touching, the male mounts from behind, its forelegs on her forewing, thorax, or fore femora, middle legs on her fore femora, and hind legs on the ground. The male’s abdominal apex curves sideways over the female’s, twists around, and then engages. Copulation lasts 54–114 seconds (14 observations).

Remarks. Small female melanics have a very superficial resemblance to *Epipompilus insularis* females, but can at once be distinguished by the concealed labrum, the long first segment of the fore tarsus, the transverse groove on the second metasomal sternum, and other features (see p. 38).

Larger collections from Peel Forest (type locality of both *conformis* and *diligens*) would have revealed a slender range of intermediates between the reddish *diligens* and *conformis*, its southern melanic form. In fact Smith (1876) described a “*diligens*, type B – the abdomen with irregular ferruginous stains” from Peel Forest, and stated that the *diligens* holotype had “the extreme apex of the abdomen ferruginous”. Their relatedness had not hitherto been suspected. Peel Forest is at the northern limit of an approximately 70-km-wide ‘hybrid band’ in which *conformis* populations separate into reddish and blackish colour morphs. North of this zone specimens have the metasoma red; south of it they are black. The location of the hybrid band, the low number of intermediates in it, electropho-

retic tests, and experiments I have conducted suggest that *conformis* (red metasoma) and *diligens* (black metasoma) are not in panmixis, a situation which may date from separation and post-glacial convergence in the area of a pre-glacial cline. This complex situation is discussed more fully on p. 14 and in Harris 1974 ("Geographical variation", "Biogeography", and "Parallel ecophenotypical colour variation").

NITIDIVENTRIS GROUP

Diagnosis. ADULT medium-sized. Wings clear hyaline, sometimes variably tinted with pale fuscous. Body and appendages black. Female malar space long. Female hind tibia with a dorsal series of small, rounded tubercles (but never with large, squamiform, chevron-shaped, or ridge-shaped teeth). Postocellar line almost always exceeding ocular-ocellar line. Male subgenital plate broadly ligulate, fringed with very long, erect setae.

LARVA. Head setae of moderate length (LS/OD) approximately 0.59). Spiracles with small spines visible at $\times 200$ on all internal ridges lining atrium; maximum diameter of subatrium not greatly exceeding that of atrium (usually the same, or less). Labrum with 10–14 setae and 12 large, submarginal, pigmented sensory cones. Spicules on median epipharyngeal lobe not extending far beyond its apical margin.

BEHAVIOUR. During prey carriage, spiders are pushed forwards. Even very large spiders of much greater bulk and weight than the wasp are straddled and transported forwards, venter uppermost, grasped (often in the middle of the prosomal venter) by the base of a second or third leg coxa.

Remarks. The two species in this group — *P. (T.) nitidiventris*, which is exclusively sand-nesting, and *P. (T.) ordishi*, which nests in clay — are very closely related. They nevertheless show consistent differences in both sexes throughout their range, from Spirits Bay (34°27'S) to southern Stewart Island (47°14'S); for example, in male genitalia, the male subgenital plate, and the parallel series of long setae on the first segment of the foretarsus of *nitidiventris* females (absent in *ordishi*). There is no overlap or intergrading of these structures, even in places where the two species occur in close proximity. At Green Lake (FD), for instance, *nitidiventris* occurs on a small strip of sand fringing this tiny lake, and *ordishi* is abundant on the clay banks, 0.5–1 m high, behind the sand.

The habit of pushing even very large spiders forwards in front of the wasp occurs in unrelated obli-

gate psammophiles such as *Pompilus plumbius* (Fabricius) from Europe. The fact that *ordishi* also pushes large spiders forwards — unusual in a species that nests in clay, where prey is transported through grass and other obstacles — lends support to the idea that it is comparatively recently derived from *nitidiventris*.

Despite the great differences in coloration of the body, appendages, and wings, *ordishi* and *nitidiventris* have many structural similarities to *P. (T.) conformis* (e.g., in the male genitalia and subgenital plates, wing venation, and female hind tibiae with dorsal series of small, rounded tubercles rather than large, squamiform teeth).

Priocnemis (Trichocurgus) nitidiventris (Smith) new combination

nitidiventris Smith, 1878, p. 6 (*Priocnemis*). Kirby, 1881, p. 38; 1884a, p. 68 (*Priocnemis*). Hutton, 1881, p. 109 (*Priocnemis*); 1904, p. 97 (*Salius*). Dalla Torre, 1897, p. 223 (*Salius*). Cameron, 1903, p. 297 (*Salius*). Tillyard, 1926, p. 292 (*Salius*). Miller, 1971 (and 1984), p. 26 (*Salius*).

carbonarius Smith, 1855, p. 162 (*Pompilus*). Cameron, 1898, p. 49 (*Salius*); double misidentification with *nitidiventris* Smith).

huttoni Cameron, 1898, p. 49 (*Agenia*). Cameron, 1903, p. 297 (*Pseudagenia*). Dalla Torre, 1897, p. 199 (*Pseudagenia*). Hutton, 1904, p. 97 (*Pseudagenia*).
New synonymy.

ADULT

Diagnosis. FEMALE medium-sized (6–14 mm long). Body black; wings hyaline, or lightly tinted with pale fuscous. Malar space long. Fore tarsus with a comb, its 1st segment bearing 5 or 6 long, parallel setae (usually slightly longer than the tarsal width) which project laterally on the outer side (cf. *ordishi* — such setae absent). Dorsal row of teeth on hind tibia vestigial, comprising 7 very small, rounded tubercles, none of them squamiform. Middle femur with 1 apical spine; hind femur with 1 apical spine, rarely 2.

MALE. Body black; wings hyaline, or lightly tinted with pale fuscous. Malar space long. Subgenital plate never constricted medially, never panduriform (cf. *ordishi*, which is so constricted), fringed with long setae somewhat shorter than those of *ordishi*. Detached genitalia in ventral view with paramere stout, rather parallel-sided, never apically clavate; ventral surface appearing broad and flat (cf. *ordishi*, in which paramere ventrally never broad and flat) (Figure 62; Key-figure 11a, cf. 11b).

Description. Female. Length 6.8–12.0 mm; forewing 6.0–11.3 mm.

COLOUR AND VESTITURE. Body and appendages usually entirely black; distal half of mandibles and tarsal claws sometimes reddish. Wings hyaline, sometimes with fuscous tinting, sometimes without; stigma and veins *C+Sc*, *R*, *M+Cu1*, and *1A* black, opaque, remaining veins pale fuscous-black, translucent (Figure 24). Head, mesosoma, fore coxae, and metasomal sternite moderately covered with erect, white hairs; declivity of 1st tergum of metasoma with very few hairs; pygidial tuft relatively sparse. Head with a patch of dense, silvery-white pubescence between eye, antennal sclerite, and frontoclypeal suture. Finer, more sparse white pubescence on mesosoma, legs, and metasoma except pygidium, where it is pale ferruginous.

STRUCTURE. Head with mentum unspecialised, submental bristles short, erect. Malar space long (0.26–0.39× as long as antennal segment 2) Clypeus about 2.60× as wide as high, weakly emarginate, with a subapical series of about 28 coarse, uneven punctures bearing erect setae. Clypeus and apical half of frons with small punctures, these often contiguous. Basal part of frons and vertex with small, distinct punctures. POL:OOL about 3:2, variable. Large punctures from which arise erect setae widely spaced on head. Propodeum evenly rounded, minutely granular (colliculate); lateral tumescence behind spiracle very obtuse. Middle and hind femora each with 1 apical spine, less often with 2. Tibiae with both dorsal and lateral spines. Dorsal row of teeth on hind tibia reduced to a series of 8 small tubercles, each immediately behind its associated seta, diminishing apically, the basalmost one largest. (Nevertheless, even the first 4 tubercles are rounded — none is squamiform.) Fore-tarsus with a well developed comb, its 1st segment bearing 5 or 6 long setae (often slightly longer than tarsal width) which project laterally on outer side. Hind tarsus with 3 median and 2 lateral pairs of spines on 5th segment.

Measurements: see Appendix 1, Table 2.

Male. Length 4.5–9.0 mm; forewing 3.8–8.0 mm.

COLOUR AND VESTITURE. Body and appendages black, shining, at times tending to dark reddish-brown. Apex of mandibles reddish-fuscous. Wings hyaline, completely clear or lightly infuscated (see Variation, below). Veins *C+Sc*, *R*, *M+Cu1*, and sometimes *1A* black, opaque; remainder brown, translucent. Stigma fuscous, faintly translucent. Head and thorax with erect, hoary hairs. Propodeum with sparse, erect, fine, white hairs, mostly on sides. Metasoma with erect, fine, white hairs beneath, grading to pale ferruginous on pygidium. Dense, silvery-white pubescence between eye and antennal sclerite, and on clypeus and gena, abraded on vertex. Finer white pubescence elsewhere on legs and body, except metapostnotum. Dense, white

pubescence on thoracic venter. Pubescence on metasomal tergites silvery, decumbent, aligned with body axis except on decurved apical 0.14 of each segment, where it is sharply inclined laterally and more dense. This often lends to the metasoma a characteristic cinereous banding when viewed dorsally with the unaided eye.

STRUCTURE. Head with clypeus about 2.8× as wide as high. Malar space long, about 0.21–0.33× as long as antennal segment 2. Frons moderately shining, with small, contiguous, minutely colliculate punctures and larger, scattered punctures at bases of erect hairs; median frontal sulcus entire, obsolete, or absent (see Variation, below). Propodeum evenly rounded, without a median impressed line; spiracle prominent; lateral tumescence behind spiracle very depressed, although slightly more defined than in female. Middle and hind femora sometimes with a single, subapical, lateral spine. Apices of tibiae with spines laterally and above. Fifth tarsal segments without pre-apical spines; claws dentate. Forewing with marginal cell removed from wing-tip by about 0.65× its own length. First segment of metasoma with dorsal declivity moderately steep. Sixth sternum apically with a pair of very faint carinae. Apex of subgenital plate, *in situ*, projecting as a distinctive, very broadly ligulate structure bordered with a fringe of long setae, their length less than three-quarters maximum width of plate; other setae — e.g., on disc — very much smaller. Subgenital plate (dissected) not constricted medially or panduriform (Figure 51). Genitalia (Figure 62) with aedeagus, parapepial lobe, and digitus of roughly equal length; paramere projecting much further. Apex of digitus volsellaris barbed inwardly, bearing laterally on its apical quarter relatively large sensillae basiconicae. Parameres (Key-figure 11a) broad, rather parallel-sided in ventral aspect, not clavate apically, each appearing to have a broad, flat, horizontal ventral surface when viewed directly from beneath (detached); basal, oblique, squaliform keel moderately short (not notably raised as in *ordishi*).

Measurements: see Appendix 1, Table 2.

Variation. **COLOUR AND VESTITURE.** In most samples from throughout New Zealand about 55% of either sex have the forewings clear hyaline. In the remainder they are to a varying extent tinted with pale fuscous. Such tinting affects the membrane in the centre of the cells, and leaves a clear margin near the vein. The density of both hairs and pubescence is variable, particularly on the frons. Differential abrasion and age possibly account for some of the variation in pubescence.

STRUCTURE. In either sex there is considerable variation in such ratios as POL:OOL, and the

second and third submarginal cells may be of equal length or either one exceed the other. Variation occurs in most of the ratios used, for example by Evans (1962) (see Appendix 1, Table 2; Harris 1974, tables 21–24).

In females the malar space is noticeably longer in some localities. In specimens from the Bealey–Waimakariri river junction (NC) it is slightly incurved below. The clypeus of some specimens bears two pairs of symmetrical, semilunar impressions, and this character is common in the south-western Tararua Range (WN). The metapostnotum is variably sculptured; for example, specimens from Ahipara Bay, Kaitaia (ND) have three transverse carinae across the middle, Paekakariki (WN) specimens have two, and Waioatauru River specimens (Otaki Forks, Tararua Range, WN) have one. Most individuals have only one apical spine on the hind femur. In those that have two spines, both the position and shape of the spines vary.

In males the median frontal sulcus is sometimes entire, extending as a narrow impression from clypeus to anterior ocellus (e.g., many specimens from Paekakariki Beach and Waioatauru River (WN), and Pines Beach, Christchurch (MC)), or is completely absent (e.g., many specimens from Ahipara Beach, Kaitaia (ND), and Ocean Beach (SI)). The subgenital plate is relatively constant, and the digitus volsellaris and paramere show minor variation only. The paramere always presents a flat, almost horizontal ventral surface when the genitalia are removed and viewed directly from below. It usually appears parallel-sided below, with a blunt apex; however, in specimens from the central east coast of the South Island its ventral outline is somewhat wedge-shaped, though flat.

TERATOLOGICAL ABNORMALITIES. Two females from Mt Ruapehu (TO) have the face very wrinkled, and deep rugae occur on the thorax and propeum as well. A female from South Waioatauru Creek (WN) has deep rugae on the head and mesosoma, and a male from that locality has the head and metasoma deeply rugose.

FINAL-INSTAR LARVA

Diagnosis. Head setae of moderate length (longest 44 μm); LS/OD 0.59. Spiracles with small spines visible on all atrial ridges at $\times 200$. Subatrium shaped as a laterally compressed cone with an attenuated portion leading from base, its diameter not greatly exceeding that of atrium (and usually less). Labrum with 14 setae and 12 large, pigmented sensory cones. Hypopharynx with small, sharp, acicular spinules on median lobe projecting beyond apical margin. (These characters must be taken together, and probably do not take account

of the full range of variation.) Larva found only in sand.

Description (based on a specimen (no. 1) from sandy delta of Matukituki River, L. Wanaka, OL, 4 Apr 1972). Length 12.0 mm; maximum width 3.72 mm.

Body (Figure 71) fusiform, more swollen posteriorly; pleural lobes rounded; anus situated lower than midway on anal segment; supra-anal lobe slightly larger than suranal lobe. Integument of thorax, particularly pleura and prothoracic dorsum, with scattered setae. Prothoracic venter with minute spinules 5.0–11.3 μm long and of several different shapes (Figure 82).

Spiracles (Figure 93) circular. Anastomosing ridges lining inside of atrium very weakly spinose (Figure 104). Opening into subatrium lined with 4–8 large, blunt-ending or bifid spines. Walls of subatrium thrown into 6 or 7 rows of irregular pockets, lined internally with groups of spines. Subatrium almost as wide as atrium, followed by a narrow, attenuated section connecting it to remainder of trachea.

Head (Figure 115): width 1.40 mm; height 1.19 mm. Frons with 4 shallow impressions between parietal bands, above level of antennal orbits. Antennal orbits 74 μm in diameter. Antennal papilla (Figure 125) 44 μm long (including apical sensillae). Longest head seta 44 μm long; LS/OD 0.59. Labrum (Figure 133) 418 μm wide, bearing 14 setae, 12 large, pigmented sensory cones, and 14 scattered sensillae; lateral lobes rather rounded in outline; median lobe large, gently convex. Epipharynx (Figure 144) with dense, large, sharply acicular spinules apically on median lobe. Conspicuous sensillae include 2 paired apical structures, and 4 cones mesad on each outer lobe, grouped in asymmetrical configurations very similar to those of other *Trichocurgus* species. (Note: the spicules on the apical margin of the median lobe of the epipharynx are shorter and less sharp than those of *P. diligens*.) Mandibles (Figure 154) 506 μm long, 330 μm wide at base, bearing 2 lateral setae and a sensory hair grouped together. Labium and maxillae (Figure 162): lacinial area of maxillae angulate, strongly produced; maxillary palp 96.8 μm long; galea 91.3 μm long; labial palp 60 μm long; spinneret 154 μm wide, with 1 or 2 spinneret setae. (The characteristic setae which partly encircle the labial palp are conspicuous. The aboral aspect presents 3 of these setae in a distinct row, of which the mesalmost on either side abuts the spinneret.) Ratios: HW/HH 1.18; ML/MW 53.

Variation. Only minor differences were noticed. Specimen 2 from Lake Wanaka had three lateral setae on the mandible, whereas all other specimens

had only two. There was some variation in the position of the setae and pigmented sensory cones on the labrum, and of the sensillae on the epipharynx.

Type data. **Holotype** female of *nitidiventris* Smith: Otago, F.W. Hutton (BMNH, Banks Collection). **Holotype** female of *huttoni* Cameron: Greymouth (BR), R. Helms (BMNH, Banks Collection). In 1972 Mr M.C. Day (BMNH) compared with the holotype of *nitidiventris* six adult females collected by me at Paekakariki Beach (WN) in November 1971.

Material examined. 1372 non-type adults (763 females, 609 males) from all coded collection areas between North Cape (latitude 34°25'S) and southern Stewart Island (47°15'S). Also 23 final-instar larvae (dissected) from Matukituki River mouth, L. Wanaka (OL, 4 Apr 1972; 8) and Castlecliff Beach (WI, 4 Jan 1972; 3), and 14 pupae. Collection localities: see Text-figure 6.

Collected from sea level to at least 1400 m (Mangaturuturu Stream, Mt Ruapehu, TO).

Adults of both sexes occur in almost equal numbers throughout October–April, and are most abundant during November–March.

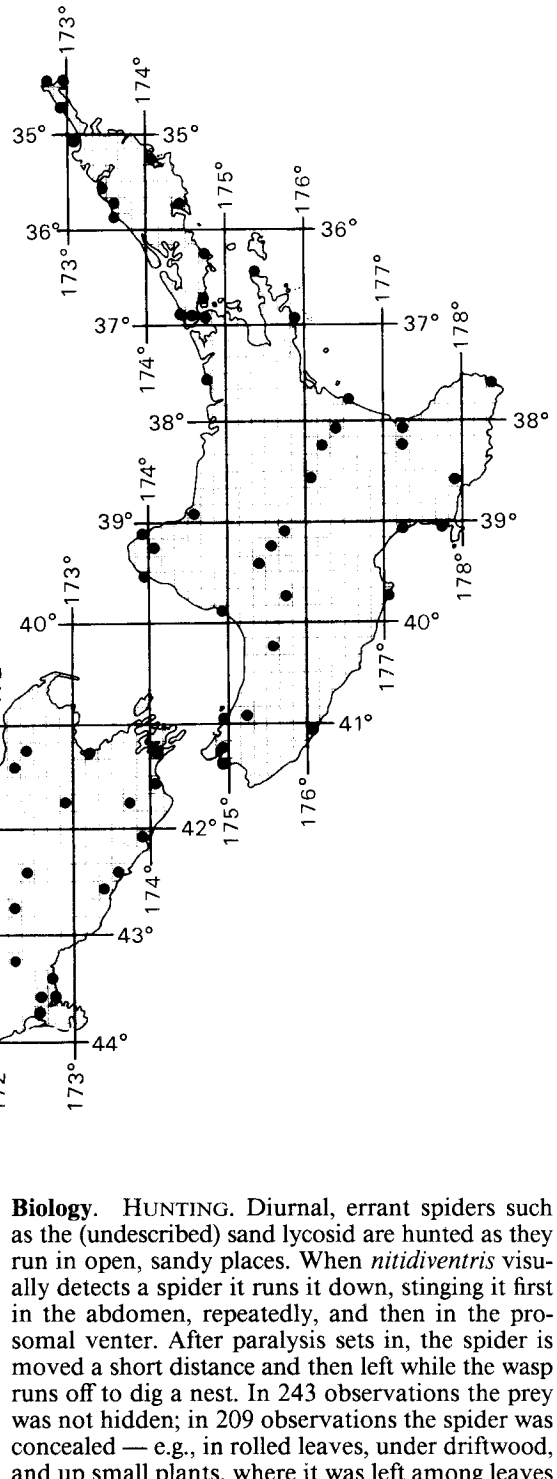

Text-fig. 6 Distribution of collection localities, *Priocnemis nitidiventris*.

Biology. **HUNTING.** Diurnal, errant spiders such as the (undescribed) sand lycosid are hunted as they run in open, sandy places. When *nitidiventris* visually detects a spider it runs it down, stinging it first in the abdomen, repeatedly, and then in the prosomal venter. After paralysis sets in, the spider is moved a short distance and then left while the wasp runs off to dig a nest. In 243 observations the prey was not hidden; in 209 observations the spider was concealed — e.g., in rolled leaves, under driftwood, and up small plants, where it was left among leaves at the crown — until the nest was dug.

Theft of prey occurs mainly where large numbers of females nest in a small stretch of sand. In all observed instances the stolen spider had been paralysed by another female of the same population.

PARALYSIS. Spiders do not recover from paralysis.

PREY CARRIAGE (Figure 172). Spiders are pushed forwards in front of the wasp. Small spiders are held by a leg base. The wasp straddles very large spiders, holds them venter uppermost by the extreme base of the third or second leg, and attempts to run forwards. Occasionally prey with the dorsum uppermost is grasped by a leg-base and pushed in front of the wasp, but usually the venter is uppermost. After digging the nest, the wasp returns for the spider and pushes it to within about 21 mm of the nest, which it enters, then emerges and drags in the spider by the spinnerets.

NIDIFICATION FORMULA. Prey - nest - egg - closure.

NEST (Figure 184). A stenotope psammophile, *nitidiventris* nests exclusively in sand — in the supralittoral in dunes, in streams and rivers, and in glaciofluvial deposits.

Nests are dug usually into sand slopes. The pecten on the forelegs is used to rake dry sand particles backwards, the legs moving rapidly and alternately and the abdomen raised, so that a shower of sand grains shoots out behind the wasp. Facing the burrow, the wasp digs steadily forwards, after about 3 minutes slowly reversing (still facing the burrow) to clear the mound that has accumulated behind it. Wet, firm sand is removed in a manner similar to that described for *monachus*. Fifty-two individuals each took on average 35 minutes to dig a nest.

Of 46 nests examined, all were single-celled. A shallow, overhung recess is constructed, usually in sloping dry sand down to firm, damp sand (Figure 185). In the horizontal floor of the recess a cylindrical, almost vertical burrow is dug, sloping at 70–90°, and 3.8–6.5 (4.0) mm wide by 15–40 (24) mm deep. Usually a pear-shaped cell about 7.5 mm wide is formed by a terminal expansion of the burrow, although sometimes the burrow is of constant diameter throughout. Spiders are generally placed about 5 mm from the end, invariably with the head facing the entrance and the legs extending in front of the body up the burrow.

After laying an egg, *nitidiventris* almost immediately begins filling in the burrow. The walls are pulled in just beyond the legs of the spider, and the sand is compacted by hammering with the abdomen. As the wasp reaches the surface it kicks in sand, clawing with the legs and sometimes scraping with the abdomen, with which it hammers at intervals. During final filling, the surface depression marking the collapsed entrance recess is disguised

by the wasp, which, digging with its forelegs, sends sand showering from beneath its raised abdomen over the entrance.

In all observations, nests were made after spiders had been captured, and all nests were single-celled. Frequently 2 or more 'false burrows' were dug (cf. *conformis*), and appetitive digging is common. Temporary sleeping burrows, in which the wasp remains during periods of inactivity, are constructed in sand by both sexes. Nest-sharing is common among males.

LIFE HISTORY. The white, curved, oblong-ovate egg, 1.8–1.9 mm long, is laid anteriorly and latero-ventrally on the host's abdomen, beside the lung-opening (Figure 186) (126 observations). Ecdysis occurs after 49 hours; fifth-instar larvae finish feeding 9 days after the egg was laid; cocoon-spinning begins 22 hours after feeding stops; and defecation occurs after a further 43 hours. After producing the meconium, the prepupa acquires protuberant lateral lobes.

Cocoons (Figure 206) opaque, pale ochreous, subpyriform, rigid, 6.5–9.2 (8.6) mm long; wall averaging 0.059 mm thick at middle. Thickness of wall at middle divided by cocoon width at middle about 0.01.

EMERGENCE AND COPULATION. Males emerge 3–10 days before females. This species is multivoltine, and males are present throughout the season, unlike those of other New Zealand Pompilidae. Copulation usually occurs above ground. Typically numbers of either sex circle an isolated, 15–20-cm-high plant or stone on otherwise bare sand. Females run around it, sometimes pausing to wriggle the abdomen. Males sometimes jump on to and mate with such females.

Remarks. *P. nitidiventris* is the common black pompilid of sandy beaches, dunes, and sandy scrolls in streams and rivers. Adults can always be distinguished from the closely related *P. ordishi* as follows. Males have the paramere appearing broad and flat in ventral view (thin and sharp in *ordishi*; Figure 62, cf. 63), and females have the row of five or six relatively long, parallel setae on the outer side of the first foretarsal segment (shorter, and not projecting at 90° in *ordishi*; Key-figure 9a, cf. 9b).

P. nitidiventris final-instar larvae are very similar to those of *P. carbonarius* and *P. conformis*, especially the latter. They can be distinguished most readily on labral characters, *nitidiventris* larvae having fewer setae and sensory cones than *conformis*, and more than *carbonarius*. The fact that in *conformis* the spiracular subatrium is much wider than the atrium at once distinguishes it from *nitidiventris*. There are few morphological differences between larval *nitidiventris* and *ordishi*. However,

the exposed sand habitat is distinctive; *ordishi* is not found in sand, and develops at a slower rate. *P. conformis* larvae occasionally occur in sand, but can be distinguished immediately by their mid-dorsal position on the host's abdomen and by the pad of web on the floor of the cell.

The distinctive long, lateral bristles on the outer side of the fore tarsus of *nitidiventris* females, although weakly developed in comparison with many overseas species, are characteristic of psammophiles, and are used during burrowing in sand. They occur convergently in unrelated, sand-dwelling pompilids. In their generic summary of *Priocnemis*, Richards & Hamm (1939, pp. 60–61) state: "The absence of a fore tarsal comb in the female may be one reason why the species [of *Priocnemis*] do not often nest in exposed sandy places." Northern Hemisphere psammophiles tend to be species of Pompilinae, which usually have longer tarsal setae than Pepsinae. *P. nitidiventris* appears to have evolved into a niche similar to that occupied by *Pompilus plumbius* in Europe, possibly because there are no Pompilinae in New Zealand other than *Epipompilus insularis*, which does not make nests. *P. plumbius*, while pushing spiders forwards like *nitidiventris* and having a sand-raker on the fore tarsus, differs in that it typically makes multi-celled nests in sand.

Priocnemis (Trichocurgus) ordishi new species

ADULT

Diagnosis. FEMALE. Body and appendages black. Medium-sized, 7–12 mm long. Wings hyaline or lightly tinted with fuscous. Malar space relatively very long. Hind tibia with dorsal tooth row consisting of small, rounded tubercles. First segment of fore tarsus with outer lateral setae much shorter than width of segment, inclined obliquely to long axis of segment, never almost as long as width of segment and never projecting at 90° as a long row of parallel bristles (cf. *nitidiventris*, which always has a row of parallel bristles). Nesting in clay soils.

MALE. Body and appendages black. Wings subhyaline, lightly tinted with fuscous. Malar space moderately long. Subgenital plate panduriform, always constricted medially, hour-glass fashion (cf. spatulate, not constricted medially in *nitidiventris*), and fringed with long, curved setae visible without dissection or eversion of genitalia. Genitalia with paramere much more slender than in *nitidiventris*, apically clavate when viewed from below; median ventral ridge basally squamiform, rising to a thin, very prominent, deltoid keel without presenting a broad, flat ventral surface (cf. *nitidiventris*, which always presents a broad, flat ventral surface).

Description. FEMALE. Length 7.0–12.0 mm; forewing 6.4–11.3 mm.

COLOUR AND VESTITURE. Similar to *nitidiventris*, but wings generally tinted with pale fuscous, and body usually with less pubescence — e.g., on hind tibia.

STRUCTURE. Head with malar space large, about 0.18–0.30× as long as antennal segment 2; front angle of ocellar triangle acute; POL:OOL about 7:12; hind ocelli usually proportionately closer together than in *nitidiventris*. Thorax often proportionately narrower than in *nitidiventris*. Fore femur usually without apical spines; middle femur usually with 1 apical spine; hind femur with 2 widely spaced spines, one basad of the other. First segment of fore tarsus with outer lateral setae much shorter than width of segment, directed at an angle to it, never projecting at 90° as a long row of parallel bristles. Fifth hind tarsal segment usually with 3 medial and 2 lateral pairs of ventral spines. Forewing marginal cell removed from wing-tip by about 0.7× its own length (Figure 25).

Measurements: see Appendix 1, Table 2.

MALE. Length 6.0–8.3 mm; forewing 5.5–7.6 mm.

COLOUR AND VESTITURE. Very similar to *nitidiventris*.

STRUCTURE. Head with malar space relatively long, about 0.18–0.30× as long as antennal segment 2, usually proportionately shorter than in *nitidiventris*. Front angle of ocellar triangle acute; POL:OOL often about 1:2; hind ocelli often proportionately closer together than in *nitidiventris*. Vertex usually appearing more shining than in *nitidiventris*. Fore femur usually without apical spines; middle femur usually with 1 apical spine; hind femur usually with 2 apical spines, one of them frequently basad of the other by a distance similar to its own length. Subgenital plate spatulate-panduriform, constricted medially, fringed with a row of long, curved bristles (Figure 52) (cf. not constricted medially in *nitidiventris*). Genitalia very similar to those of *nitidiventris*, but with paramere much more slender, appearing apically bulbous in ventral view, without an apparent broad, flat surface, and with ventral ridge basally squamose, rising to a thin, very prominent ridge (Figure 63, Key-figure 11b).

Measurements: see Appendix 1, Table 2.

FINAL-INSTAR LARVA

Diagnosis. Head setae of moderate length, the longest 45 µm; LS/OD 0.59). Spiracles round, with small spines on all internal atrial ridges (visible at ×200); subatrium in the form of a laterally compressed cone, its diameter not greatly exceeding that of atrium, and usually less. Labrum with 10–12 setae and 12 large, pigmented subapical sensory

cones. Median lobe of epipharynx with small, blunt spinules not projecting beyond apical margin. (These characters cannot be used independently, and probably do not take account of the full range of variation).

Usually found in clay soils, below ground level, never in sand.

Description (based on a specimen from Flagstaff Hill, Dunedin, DN, 13 Mar 1972). Length 9.5 mm; maximum width 3.2 mm.

Habitus very similar to *P. nitidiventris*. Prothoracic venter with spinules as in Figure 83.

Spiracles circular, similar to those of *nitidiventris*. First thoracic spiracle (Figure 94a,b) 50 μ m in diameter at outer atrial rim; anastomosing ridges with very weak spines; collar spines large, similar to those of *nitidiventris*; subatrium well developed, ovoid in cross-section, dilated posteriorly, its maximum diameter less than that of atrium, its walls thrown into 6 or 7 rows of folds, internally with grouped spines.

Head (Figure 116): width 1.06 mm; height 0.85 mm. Parietal bands weakly pigmented, short, 299 μ m long, indistinct beyond antennal orbits. Antennal orbits 100.9 μ m in diameter; papilla well developed, 46.3 μ m long (including apical sensillae). Labrum (Figure 134) 339.9 μ m wide, 97.8 μ m in median height, bearing 12 submarginal pigmented sensory cones, 14 setae, and 6 large, campaniform sensillae, the arrangement of all types of sensillae notable for its symmetry; median lobe with apical margin more rectilinear than in *nitidiventris*. Epipharynx (Figure 145) with median lobe small, its apical and subapical spicules resembling short, blunt, rounded tubercles, thus differing from the sharp, acicular spicules of *nitidiventris*. Longest head seta (on gena) 45 μ m long; LS/OD 0.59. Mandibles (see Figure 116) 413.2 μ m long, 226.6 μ m wide at base, with 2 subequal lateral setae. Labium and maxillae (Figure 163): lacinial area of maxillae strongly, angularly produced; maxillary palpi 80 μ m long; galeae 70 μ m long; labial palpi 52.5 μ m long; spinneret 188 μ m wide, with 1 or 2 spinneret setae.

Variation. Various minor differences were noted. For example, specimen no. 2 from Flagstaff Hill (DN) had 12 setae and 12 large, pigmented sensory cones on the labrum that differed in arrangement from those on no. 1. Specimen no. 3 had 11 labral setae, 6 on the left lateral lobe and 5 on the right; the mandible had a group of 3 lateral setae, all of about the same size. Specimen no. 4 had 12 labral setae, 6 on each lateral lobe; the mandibles had only 2 subequal setae, one of them minute. Specimen no. 5 was similar to no. 1, as was the Akatarawa Saddle (WN) specimen.

Type data. **Holotype:** female, New Zealand, WN, Akatarawa Saddle, Waikanac, 610 m, in crumbling clay, 18 December 1971, A. C. Harris (NZAC). **Allotype:** same data as holotype but collected 28 January 1972 (NZAC). **Paratypes:** all specimens collected by A. C. Harris are here designated as paratypes, viz 879 adults (723 females, 156 males) from the following localities. ND – Mt Unuwahao; Spirits Bay; Waipoua. BP – Matakana I., Tauranga Harbour; Rotorua. TO – Mt Ruapehu. TK – lower Stratford Track, Mt Egmont. WN – Renata Hut, Tararua Range; Akatarawa Saddle, southern Tararua Range; Pinehaven; Wainuiomata. NN – Takaka Hill; Riwaka Valley. BR – L. Rotoiti; L. Daniells. WD – Kelley's Creek, Otira. NC – Mt Hamilton; Craigieburn; Porter's Pass. MC – Long Bay, Little River, Kaituna Valley, Price's Valley (all Banks Peninsula); Herbert Peak; Kakapo Stream, Wilberforce Valley. MK – Black Birch Stream, Mt Cook; Waitangi, L. Aviemore; Lindis Pass. CO – Dansey's Pass; Keyburn Diggings; Omarama; Naseby; Taieri Ridge; Kokonga; Lammermoor Range, 1160 m; Old Woman Range, Duffer's Saddle; Dunstan Range; Roaring Meg, Kawarau Gorge; Obelisk Range, 1280 m; Old Man Range; Pisa Range, 1450 m; Coronet Peak, 1500 m; Rees Valley. FD – Mt Luxmore Hut; Green Lake. DN – Mt Misery; Flagstaff Hill, Dunedin; Leith Saddle, Dunedin; Mt Cargill, Dunedin; Berwick Forest. SL – Tautuku. SI – Oban.

Material examined. Type series, plus 98 non-type adults (62 females, 36 males) from Mt Unuwahao (latitude 34°26'S) to at least mid Stewart Island (47°S). Also 12 final instar larvae, and 7 pupae from Akatarawa Saddle (WN) and Flagstaff Hill, Dunedin (DN). Collection localities: see Text-figure 7.

Collected from sea level to at least 1450 m (Obelisk Range, CO).

Adult females were recorded from September to May, and were most abundant from October to March. Adult males were recorded from December to March, and were often abundant during March.

Biology. HUNTING. Diurnal, errant spiders (e.g., *Trite* spp., *Lycosa* spp.) are hunted as they run over the ground in sunshine. When detected visually they are run down and stung, first in the abdominal venter, then in the prosomal venter. After paralyzing a spider the female wasp leaves it, returns to its nest, and enlarges the terminal spur. Prey is usually not concealed but is left exposed, venter uppermost.

PARALYSIS. Spiders do not regain movement.

PREY CARRIAGE (Figure 173). Small spiders are held by the base of a third leg coxa and shoved forwards. Only in difficult places, after several attempts, does the wasp reverse and drag prey

backwards for a short distance before resuming forward pushing. Very large spiders are straddled venter uppermost, grasped by the base of a third leg coxa, and hauled forwards.

NIDIFICATION FORMULA. Nest - prey - egg - (cell) - closure.

NEST (Figure 187). In sloping, compacted clay a nest is often dug almost exclusively with the apex of the abdomen and the front legs, in the initial stages at least. The abdomen acts as a gouge; the legs scrape.

Forty-six nests were observed in compacted clay tracks and roads, the sides of wheel-ruts, clay gutters, clay banks, and compacted clay surfaces, from 20 m above sea level to over 2000 m. Of 34 dissected nests, all were multi-celled and in clay. Sometimes cells are made in the sides of pre-existing burrows (six observed nests), but only burrows constructed by *ordishi*. The wasp sometimes begins by forming in the clay substrate a recess similar to that of *nitidiventris* in sand. In the horizontal floor of the recess a cylindrical, almost vertical burrow is made, averaging 4.15 mm wide. Twenty-eight completed nests contained 4-12 (7) cells. The main burrow was 4.1-4.4 mm wide, 9.3-14.2 (10.2) cm

Text-fig. 7 Distribution of collection localities, *Priocnemis ordishi*.

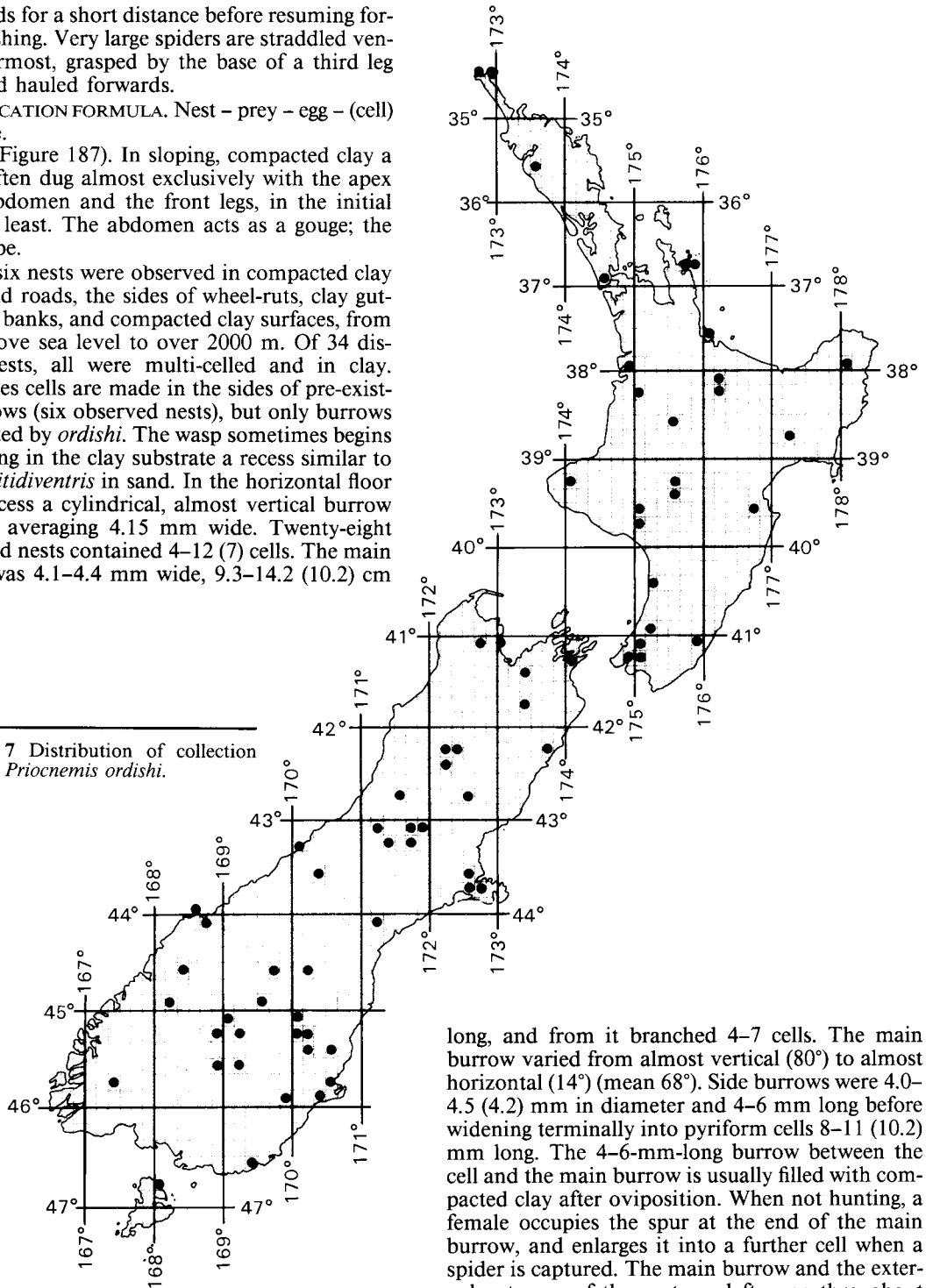

long, and from it branched 4-7 cells. The main burrow varied from almost vertical (80°) to almost horizontal (14°) (mean 68°). Side burrows were 4.0-4.5 (4.2) mm in diameter and 4-6 mm long before widening terminally into pyriform cells 8-11 (10.2) mm long. The 4-6-mm-long burrow between the cell and the main burrow is usually filled with compacted clay after oviposition. When not hunting, a female occupies the spur at the end of the main burrow, and enlarges it into a further cell when a spider is captured. The main burrow and the external entrance of the nest are left open throughout the cycle.

*carbonarius**crawi***Female**

Ocelli	usually widely spaced; OOL usually less than twice POL, from 5:9.4 to 3:4 (Key-fig. 7a)	usually closely grouped; OOL usually more than twice POL, from 4:10.5 to 4.9:11.6 (Key-fig. 7b)
Surface of vertex	dull black, appearing somewhat rough	shining jet-black, usually appearing smooth
Hind tibial tooth row	teeth 3–7 (counting from base) comparatively small, narrow, and slanting; basally with a single row of about 2 small teeth (Key-fig. 8a)	teeth 4–8 appearing as large, very broad, semilunar scales; basally often with a double row of about 4 small teeth (Key-fig. 8b)

Male

Paramere of genitalia (side view)	massive, flat, below with a shallow, wide indentation at about midway bounded apically by a prominent swelling; outline suggesting a boot (Key-fig. 10a)	slender, subcylindrical, tapered more or less evenly, below without an obvious shallow, wide indentation bounded apically by a prominent swelling; outline not suggesting a boot (Key-fig. 10b)
Subgenital plate	long, subcuneiform (Fig. 53)	short, squat, very broad (Fig. 54)
Frons between and just above antennal sclerites	not notably swollen, not elevated medially to a point; often with a conspicuous median sulcus	distinctly swollen medially, rising to a point; never with a deep, wide median sulcus

LIFE HISTORY. The white, oblong-ovate, very slightly curved egg, 1.8–2.9 mm long, is laid ventrolaterally about midway along the host's abdomen (Figure 188) (28 observations). Eclosion occurs after 4 days. The fourth instar is attained about 14 days after the egg was laid, and the fifth after 22 days. Cocoon-spinning begins after 26 days.

Cocoons (Figure 207) are opaque cinnamon-brown, subpyriform, rigid, 8–10 (9) mm long, and average 0.06 mm thick at the middle. The thickness of the wall divided by cocoon width at the middle is 0.01. Cocoons occur under the ground in heavy soils.

Remarks. *P. ordishi*, like *P. nitidiventris*, shows little latitudinal variation, and the male terminalia show little variation throughout its range. It nests in clay soils, and is seldom found on sand.

Although *ordishi* is very similar to *nitidiventris*, females can always be distinguished by their lack of a lateral row of long, parallel setae on the first foretarsal segment, and males can always be distinguished by their panduriform, medially constricted subgenital plate and lack of a broad, flat, ventral surface to the paramere, which is always much more slender than in *nitidiventris*.

Many of the 21 ratios of body dimensions fall outside the range for *nitidiventris*, although the high

extremes for one species overlap with the low extremes for the other (see Harris 1974, tables 21–28). The thorax is often slightly more narrow. Most specimens have the wings lightly tinted with fuscous, whereas in *nitidiventris* roughly 55% have the wings clear hyaline.

CARBONARIUS GROUP

Diagnosis. ADULT. Medium-sized to small; females 5–11 mm long. Wings clear hyaline, sometimes variably tinted with pale fuscous. Body and appendages black. Female: malar space ranging from moderately long to extremely short; hind tibia always with a dorsal series of large, squamiform, chevron-shaped or slanting, carinate teeth; ocellar-ocellar line greatly exceeding postocellar line (*crawi*) or shorter than postocellar line (*carbonarius*). Male: subgenital plate with comparatively short setae evenly distributed over disc, without a lateral fringe of long setae.

LARVA. Head setae of moderate length; LS/OD approximately 49–51. Spiracle: atrium with internal anastomosing ridges lacking visible spines (at $\times 200$); greatest diameter of subatrium where it is complexly folded less than that of atrium.

BEHAVIOUR. Spiders are transported backwards. Even spiders smaller than the wasp (although not very small spiders) are dragged backwards over easy terrain, venter up, by the base of a second or third leg coxa.

NEST. Both single-celled and multi-celled nests are made by *carbonarius* and *crawi*. Multi-celled nests of both species often occur in the nests of solitary bees, where the wasp cells frequently branch from the upper parts of the bee burrow.

Remarks. The two species included in this group are closely related, but are distinct and easily distinguishable throughout their range. *P. (T.) carbonarius* is more abundant in the north and in the lowlands, whereas *P. (T.) crawi* is most numerous at higher altitudes and in the south. Both species have very distinctive forms in central and eastern Otago. These do not extend far into Fiordland; they are bounded in the north by the upper Waitaki River and the Kakanui and Horse ranges, and their southern limits are near the Hokonui Hills. Specimens of *crawi* from Stewart Island and southern Southland, and both *crawi* and *carbonarius* from Fiordland, the West Coast, Canterbury, and Nelson-Marlborough are similar to North Island examples.

Both *carbonarius* and *crawi* are somewhat variable, and characters such as the relative size of the second and third submarginal cells, the size of the malar space, the teeth in the dorsal row on the female hind tibia, and the ratio POL:OOL differ considerably over small distances. However, when these and other characters are examined together, identification is not difficult.

The most useful characters for distinguishing between *carbonarius* and *crawi* adults are summarised in the table opposite.

Priocnemis (Trichocurgus) carbonarius (Smith) new combination

carbonarius Smith, 1855, p. 162, no. 218 (*Pompilus*). Kirby, 1881, p. 38 (*Pompilus*); 1884a, p. 68, no. 16 (*Priocnemis*). Dalla Torre, 1897, p. 216 (*Salius*). Cameron, 1903, p. 297 (*Salius*). Hutton, 1904, p. 97 (*Salius*). Tillyard, 1926, p. 297 (*Salius*). *nitidiventris* not of Smith, 1878, p. 6 (*Priocnemis*). Cameron, 1898, p. 42 (*Salius*) [double misidentification with *carbonarius* Smith].

ADULT

Diagnosis. **Female.** Medium-sized to small (6.0–10.0 mm long). Body and appendages black. Wings clear hyaline or lightly tinted with pale fuscous. Head with vertex dull black (seldom shining jet-black); punctures contiguous, the surface appearing

somewhat rough; ocelli widely spaced, the ocellar triangle appearing relatively large (see Key-figure 7a) — POL:OOL usually from 5:9.4 to 6:8 (0.53–0.77), and OOL usually less than twice POL. Hind tibia with a single row of 10 dorsal, scale-like teeth, numbers 3–7 (counting from base) large, the others reduced; compared to *P. crawi* teeth 3–7 small, narrow, ridge-shaped, and not projecting at a sharp angle to tibial surface; tibia basally with a single row of small, squamiform teeth (Figure 34). Malar space variable: in typical form (entire North Island, and South Island except central and eastern Otago) malar space extremely short, and jaw little separated from base of eye; in central and eastern Otago form, malar space moderately long and curved inwards below.

Male. Body and appendages black; wings clear hyaline, or very lightly tinted with pale fuscous. Hairs very sparse, pale golden, infuscated around eyes. Pubescence mostly silvery white. Frons not notably swollen above and around antennal sclerites, never elevated medially to a point between antennal sclerites, and usually with a shallow median sulcus between antennae. Subgenital plate (Figure 53) long, subcuneiform, evenly covered with short setae, without a lateral fringe of long setae; apex broadly and evenly rounded. Paramere (when viewed from the side) appearing short, massive, and flat, below with a shallow, wide indentation at about midway bounded apically by a prominent swelling; outline somewhat suggesting a boot (Figure 12, Key-figure 10a).

Description. **Female.** Length 6.5–9.8 mm; forewing length 6.8–9.0 mm.

COLOUR AND VESTITURE. Body mostly black; mandibles and tarsal claws with apices rufous. Pubescence: mostly whitish; dense, silvery, and decumbent on clypeus and on frons between compound eyes and antennal sclerites, forming para-occipital patches; finer elsewhere, bronzy on remainder of frons and vertex, and on pronotum and scutum, grading to silvery on rest of mesosoma, including scutum and propodeum; whitish on metasternites and declivity of tergum 1, but grading to pale bronze on metasomal dorsum. Erect hair sparse, restricted on head to mandibles, gena, a subapical series on clypeus, and a row on vertex and frons fringing the eye; elsewhere occurring on coxae, trochanters, propleuron, thoracic dorsum, and apex of metasoma. First metasomal tergum with sparse hair at extreme base only; declivity without hair. Wings usually almost clear hyaline, very faintly tinted with fuscous, often a longitudinal fuscous band through submarginal cells to wing apex. Stigma and veins *C+Sc*, *R*, *M+Cu1*, and basal part of *1A* black, opaque; remaining veins

pale fuscous, translucent.

STRUCTURE. Head with malar space minute to moderately large (0.02–0.24× as long as antennal segment 2). Relative to *crawi*, frons swollen between and above antennal sclerites. Median frontal line usually entire, moderately impressed, often with a wide, shallow depression. Frons and vertex with small, relatively deeply impressed punctures. Vertex appearing dull black, its surface somewhat rough. Ocelli widely spaced, relative to *crawi*; front angle of ocellar triangle less than 90°; POL:OOL usually about 7.5–10.0. Labium and maxilla in ventral aspect as in Figure 4. Metasoma, particularly thoracic dorsum, with small, deeply impressed punctures, the surface usually dull and somewhat rough. Propodeum rounded, usually without a median impressed line; dorsolateral tumescence obsolete. Fore femur without apical spines; middle and hind femora with respectively 1 and 2 minute spines low on outer side of extreme apex. Tibiae with apical spines discontinuous above; hind tibia with a dorsal row of 10 prominent, very squamiform teeth, the first 2 or 3 (counting from base) minute, without bristles, usually in a single row; teeth 4–9 appearing as somewhat triangular scales, relative to *crawi* teeth somewhat flattened, narrow, appearing longer than wide (Figure 34). Fifth tarsal segment ventrally usually with only 3 very reduced median spines and 4 apical spines, occasionally with a minute sublateral pair. Claws dentate, the tooth usually more apical in position than in *nitidiventris*. Forewing marginal cell removed from wing-tip by about 0.9× its own length (Figure 26). First tergum of metasoma with declivity moderately steep.

Measurements: see Appendix 1, Table 2.

Male. Length 5.0–7.4 mm; forewing 4.0–6.5 mm.

COLOUR AND VESTITURE. Mostly black; mandibles and tarsal claws with apices reddish. Moderately shining. Pubescence on clypeus and frons dense, decumbent, silvery, forming paraoccipital patches between compound eyes and antennal sclerites. Pubescence finer elsewhere, whitish except on vertex, pronotum, scutum, tegulae, and apical 4 segments of metasoma, where it is pale bronze. Erect hairs fine, pale yellow-bronze, very sparse, restricted to frons, where about 6 border the eyes, a subapical series on clypeus and labrum, plus a few on mandibles, genae, pronotum, coxae, and genital terminalia. Wings hyaline, usually almost clear, faintly tinted with very pale fuscous, usually with a pale fuscous streak longitudinally through submarginal cells to wing apex. Stigma and veins pale fuscous, translucent.

STRUCTURE. Head with malar space minute to moderately long; frons less swollen than in *crawi*, hence antennal sclerites projecting well above sur-

face in all directions, separated from each other by a wide sulcus. Median frontal line usually entire between antennal sclerites and anterior ocellus. Front angle of ocellar triangle less than 90°; POL:OOL usually about 5:8. Head with small, relatively deep, contiguous punctures. Thorax and propodeum with small, contiguous punctures. Propodeum with an obsolete dorsolateral tubercle. Fore femur without spines; middle and hind femora with minute apical spines low on outer side. Hind tibia usually with a dorsal row of 9 small, squamiform teeth, the basal 2 without associated bristles. Forewing marginal cell removed from wing-tip by about 0.9× its own length. Subgenital plate (Figure 53) long, broad, subcuneiform, evenly covered with short setae, without a lateral fringe of long setae; apex truncated, widely rounded. Genitalia (Figure 12) with parapenial lobe and digitus volsellaris of similar length; aedeagus much shorter. Apex of digitus volsellaris forming a large, inwardly directed hook, without sensillae basiconicae. Paramere projecting well beyond other lobes, in ventral view broad, cuneiform, with the apical quarter curved inwards, in lateral profile appearing short, massive, and flat, with a prominent, rounded projection slightly basad of midway on its ventral margin.

Measurements: see Appendix 1, Table 2.

Variation. COLOUR AND VESTITURE are almost constant.

STRUCTURE. There is considerable variation in the relative size of submarginal cells 2 and 3, the ratio POL:OOL, and the size of the malar space. Throughout most of New Zealand the malar space varies from almost completely absent to 0.10× as long as antennal segment 2, i.e., a short malar space is present. The malar space is slightly longer in Northland between Kaitaia and Cape Reinga, and is largest in central and eastern Otago, where specimens have a malar space of moderate length. Otago populations are bounded in the north by the upper Waitaki River, Kakanui Mountains, and Horse Range, and stop at Shag Point. To the south they stop at the latitude of the Hokonui Hills, and to westward they do not extend far into Fiordland. Central and eastern Otago populations are sharply separated from surrounding populations of the typical form, which has a shorter malar space, and steeply stepped clines occur on the boundaries. The subgenital plate and genitalia are almost constant.

TERATOLOGICAL ABNORMALITIES. A female from Dun Mountain (NN) has the submarginal cell subdivided by an additional vein connecting the second radial sector and the third radio-medial cross-vein. One female from Akatarawa Saddle (WN) and two from Banks Peninsula have the head and mesosoma strongly rugose.

FINAL-INSTAR LARVA

Diagnosis. Head with setae on vertex and temples of moderate size (longest about 35 μm); LS/OD 51. Clypeus with a shallow, median vertical impression. Lateral lobes of labrum very rounded in outline; median lobe moderately convex, but apical margin not produced into an acute point in middle. Epipharynx with spinules on apical part of median lobe small, acicular. First thoracic spiracles: subatrium broadest where complexly folded, narrower than greatest diameter of atrium; spines not visible at $\times 200$ on internal ridges lining proximal half of atrium; smooth-walled area proximal to folded part of subatrium not greatly narrowed.

A ground-dwelling larva, commonly occurring in clay soils, in compound nests off the sides of cylindrical burrows made by other insects such as alkali bees and Cicindelinae.

Description (based on a specimen from an alkali bee burrow, Karori, Wellington, WN, 1 Jan 1971). Length 10.0 mm; maximum width 3.5 mm.

Body (Figure 72) rather slender, fusiform; pleural lobes gently and evenly rounded; supra-anal lobe much larger than suranal lobe; anus situated lower than midway on anal segment. Prothoracic pleura with sparse, scattered, small setae 16 μm long. Prothoracic venter with spicules (Figure 84) ranging in size from 6 μm long by 3 μm wide at base to 10 μm long by 5.2 μm wide, though mostly of the order of 8 μm by 4 μm .

Spiracles round, similar in basic organisation to those of *nitidiventris*. First thoracic spiracle (Figure 95) 80 μm in diameter. Atrium with anastomosing ridges almost regular, those on outer half of atrium with minute, acicular spines; cells bounded by atrial ridges elongate, without vertical extensions. Collar spines prominent. Subatrium with prominent, grouped teeth. Greatest diameter of subatrium less than that of atrium; no extremely constricted area between proximal end of subatrium, where it is thrown into complex folds, and rest of trachea.

Head (Figure 117): width 1.11 mm, maximum height (excluding labrum) 0.90 mm; with 4 weak, rectangular impressions transversely on frons between parietal bands, above level of antennal orbits. Parietal bands moderately short (365 μm), very weakly pigmented, not extending beyond lower limits of antennal orbits. Antennal papillae (Figure 126) long — length, excluding the 3 apical sensillae, 33 μm ; basal width 14 μm ; terminal sensillae 10 μm long. Greatest diameter of antennal orbits 68 μm . Vertex and temples with setae moderately long. Labrum (Figure 135) with 13 setae and 10 submarginal, pigmented sensory cones; width 319 μm ; median height 85 μm . Lateral lobes well sepa-

rated medially by a wide, entire sulcus, very rounded in outline, each lobe concave at middle of its apical margin, from which it curves around in a wide angle to base on either side; outer apical margins with large, projecting spicules. Apical margin of median lobe evenly convex. Epipharynx (Figure 146) with spicules simple mesally and complex on sides. Spicules on median lobe small, dense, acicular. Longest head seta 35 μm ; LS/OD 0.51. Mandibles (Figure 155) with 2 lateral setae; length 425 μm , width 281 μm ; ML/MW 1.51. Clypeus with a shallow, wide median impression, and 6 setae arranged medially on either side in evenly spaced groups of 3. Labium and maxillae as in Figure 164; maxillary palp 79 μm long, 37 μm wide at base; galea 68 μm long, 31 μm wide at base. Lacinal area of maxillae spinulose, strongly and angularly produced. Spinneret 100 μm wide; labial palpi 21 μm long. Two setae posterior and mesal to labial palp probably qualify as “spinneret setae” as described by Evans (1957).

Variation. Of 5 larvae taken from a single compound nest at Karori on 10 Jan 1972 and reared to the final instar, two bore 15 setae on the labrum, one had 10. One specimen had four clypeal setae, rather than six.

Type data. **Holotype** of *carbonarius* Smith: Auckland (AK), Bolton (BMNH).

Material examined. 677 non-type adults (532 females, 145 males) from Spirits Bay (latitude 34°27'S) to at least as far south as Dunedin (45°53'S). Also 8 larvae, from WN and MC. Collection localities: see Text-figure 8.

Collected from 1 m above sea level to at least 600 m.

Adult females were recorded from November to March, and adult males from October to February; both sexes were most abundant in January and February.

Biology. HUNTING. After a chase, *carbonarius* females often leap at prey, stinging it repeatedly in the abdominal venter and then the prosomal venter, sometimes for up to about 45 seconds, long after the spider is immobile. The spider is then sometimes hidden before the wasp runs to inspect its nest. Single-cell nesters often conceal the spider, then return for it after finding a suitable nesting hole. Spiders are dragged to within about 4 mm of the nest entrance. The wasp enters the nest, then emerges and drags in the prey by the spinnerets. It remains with the spider for 1.5 to 3 hours before filling in the section between the cell and the main burrow (multi-celled nests) or nest (single-celled

ests). Once the single-celled nest is filled to the surface, the entrance area is disguised in a manner similar to that employed by *conformis* (q.v., p. 45).

When large numbers of wasps are present at the same time (as occurs in warm, sunny weather on some mountains — e.g., Obelisk Range, CO, at 2200 m), females may steal paralysed spiders that are left near the entrances of nests, or elsewhere. When a hunting female meets another with prey, it may attempt — sometimes successfully — to take the spider.

PARALYSIS is comparatively light; after about 24 hours, some paralysed spiders are capable of considerable movement.

PREY CARRIAGE (Figure 174). Spiders are grasped by the base of a third leg coxa and dragged backwards, venter uppermost.

NIDIFICATION FORMULA. Nest – prey – egg – (cell) – closure; also prey – nest – egg – closure.

NESTS are very variable, and may be single-celled or multi-celled. Of 143 nests dissected, 89 were in clay burrows of ground-nesting insects such as cicindelid beetles and native bees. Entire nests (including brood-chambers) are sometimes dug by

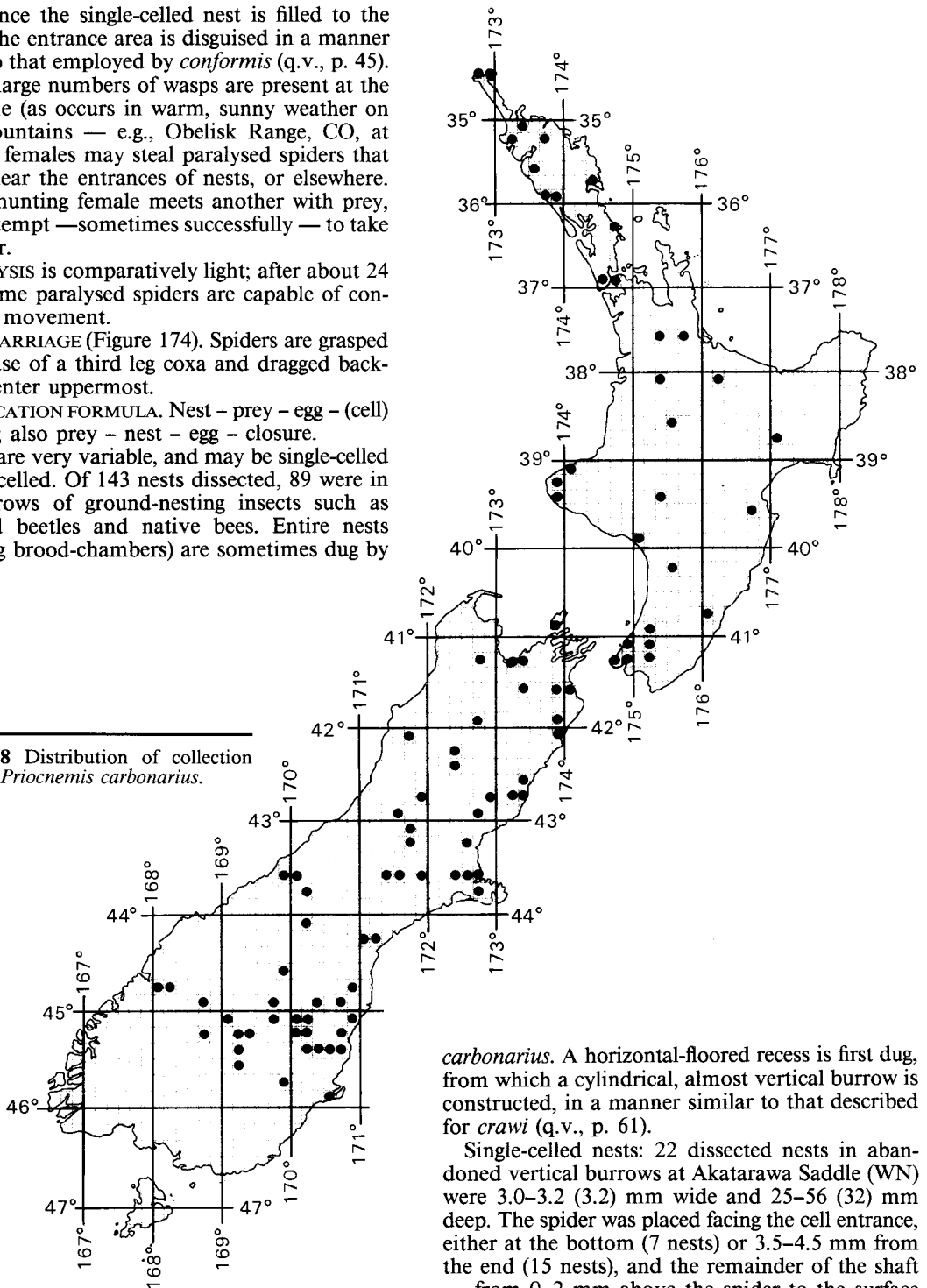

Text-fig. 8 Distribution of collection localities, *Prioncnemis carbonarius*.

carbonarius. A horizontal-floored recess is first dug, from which a cylindrical, almost vertical burrow is constructed, in a manner similar to that described for *crawi* (q.v., p. 61).

Single-celled nests: 22 dissected nests in abandoned vertical burrows at Akatarawa Saddle (WN) were 3.0–3.2 (3.2) mm wide and 25–56 (32) mm deep. The spider was placed facing the cell entrance, either at the bottom (7 nests) or 3.5–4.5 mm from the end (15 nests), and the remainder of the shaft — from 0–2 mm above the spider to the surface entrance — was filled with manuka leaves, berries,

twigs, pieces of dried lichen, small stones, etc. carried in the mandibles and rammed into place with the apex of the abdomen. Fifty-six vertical burrows from around New Zealand used as nests by *carbonarius* were similar in that all were single-celled, the burrow was filled from the single spider to the surface, and the surface around the entrance was disguised by the wasp. *P. carbonarius* sometimes makes single-celled nests in abandoned burrows of *Neocicindela parryi* (White).

Multi-celled nests (Figure 189). Most nests are multi-celled, and 61 observed nests were in abandoned native bee burrows. Sometimes the pompilid blocks off the deeper part of the burrow with a plug of compacted soil and constructs its own system of cells. Occasionally it enlarges existing (bee) cells and nests in those. Usually the bee cells are very much deeper in the substrate than those constructed by *carbonarius*. In 37 (Wellington) nests in burrows made by an undescribed *Leioproctus* (*Nesocolletes*) species main burrows were 9.5–10.4 cm long by 3.5–4.5 mm wide, and completed nests had 5–16 (6) cells. Cells were 7–11 mm long by 6.0–10.8 mm wide, and were connected to the main burrow by tunnels 3.2–5.0 mm long filled after oviposition with compacted clay. The first-made cell was from 40 mm to 53 mm below the surface. Twenty-five nests had the deeper part of the bee burrow blocked off with a plug of compacted soil, and in all 37 nests the cells and their short tunnels were made entirely by *carbonarius*. Such nests are often stocked with small Lycosidae (e.g., *Lycosa hilaris*). Although generally abandoned burrows are used, 16 observed nests were shared by *Leioproctus* (*Nesocolletes*) sp. and *P. carbonarius*, and viable pupae of both species were produced.

LIFE HISTORY. The white, opalescent, oblong-ovate, slightly curved egg, 1.5–2.2 mm long, is laid laterally and anteriorly, high on the left or right 'shoulder' of the host's abdomen (168 observations) (Figure 190). Ecdysis occurs after 2–3 days, the larval stages occupy a further 6 days, and cocoon-spinning begins 9–11 days after the egg was laid (25 larvae, laboratory reared at 23°C). Under natural conditions larval life is probably at least twice as long; e.g., an egg laid at Renata, southern Tararua Range (WN) on 18 Dec 1971 moulted into instar 5 on 29 Jan 1972. Egg position varies, depending (for example) on cell shape. Two eggs laid in an unusual, very posterior position developed normally, despite the larval heads being near the hosts' spinnerets. Prepupal diapause lasts 6–7 months, and *P. carbonarius* is univoltine.

Cocoons (Figure 208) are rigid, opaque, subpyriform, cinnamon-brown, and 7.0–9.5 (8.5) mm long. The wall is 0.059 mm thick, and the thickness of the wall divided by cocoon width at the middle is

0.01. A tightly consolidated inner wall is surrounded by a looser, fibrous outer layer which has a matrix between the fibres.

Remarks. Outside central and eastern Otago, *P. carbonarius* females are most easily distinguished from *P. crawi* females by their minute malar space. A check is then made of the condition of the vertex, ocelli, and dorsal tooth-row on the hind tibia. Eastern and central Otago *carbonarius* females are distinguishable by having the hind tibial teeth much smaller and more narrow and always with a single (rather than double) series of small, basal teeth; the ocelli widely spaced, with OOL less than twice POL; and the vertex comparatively dull and rough, not highly polished. These characters, though somewhat variable, are relatively constant throughout New Zealand. Consequently they are the most reliable, and should always be examined.

Males are distinguishable from *crawi* males by the frons not rising to a point medially between the antennal sclerites, by the long subgenital plate (Figure 53, cf. 54), and by the shape of the paramere in side view (often visible without dissection) — flat, broad, and usually with a ventral notch (Key-figure 10a, cf. 10b).

Priocnemis (*Trichocurgus*) *crawi* new species

ADULT

Diagnosis. FEMALE. Medium-sized to small (5.0–11.0 mm long). Body and appendages black. Wings clear hyaline, or lightly tinted with pale fuscous. Head with vertex shining jet-black; surface with small punctures close but not contiguous, usually appearing smooth. Ocelli closely grouped; ocellar triangle small (see Key-figure 7b) — POL:OOL usually from 4.0:10.5 to 4.9:11.6 (0.38–0.42), OOL usually more than twice POL. Hind tibia with teeth 4–8 appearing as large, very broad, semi-lunar scales, and usually with a double basal row of about 4 small teeth (see Key-figure 8b). Malar space variable: typical form (entire North Island, Stewart Island, and South Island except central and eastern Otago) with malar space moderately long, so eye well separated below from base of jaw; central and eastern Otago form with malar space very small.

MALE. Body and appendages black; wings clear hyaline, or lightly tinted with fuscous. Frons notably swollen on apical half, rising medially to a point between antennal sclerites, never depressed into a deep, wide sulcus medially, between antennae; face consequently with a distinctive, bulging appearance. Subgenital plate (see Figure 54) short, squat, very broad, apically decurved, notched medially, evenly covered with short setae, without a lateral

fringe of long setae. Genitalia in ventral aspect very similar to those of *carbonarius*, but paramere (viewed from side) much more slender, lacking any large indentation midway on ventral margin or any prominent hump at apical end, and thus appearing much more smoothly and evenly attenuated; usually it appears subcylindrical rather than flat (see Key-figure 10b).

Descriptions. Female. Length 5.0–11.0 mm; forewing 4.2–10.0 mm.

COLOUR AND VESTITURE as for *carbonarius*.

STRUCTURE. Head with malar space usually moderately long, sometimes short ($0.06\text{--}0.20\times$ as long as antennal segment 2). Frons somewhat swollen; median frontal line variable, often impressed on its lower 0.47, the remainder obsolete, apart from a short, deep sulcus before median ocellus; frontal line seldom contained within a wide, shallow, median frontal depression. Front angle of ocellar triangle acute; POL:OOL about 4:10. Frons and vertex covered with small, shallow punctures; surface shining. Thoracic dorsum with small, distinct punctures, shining. Propodeum with small, indistinct punctures, otherwise as for *carbonarius*. Femora as for *carbonarius*. Hind tibia dorsally with 11–16 teeth, 10 of them in a primary row, with numbers 4–8 (counting from base) usually very large, scale-shaped, semilunar, and projecting sharply; basally with a second series of 2–6 teeth (usually 2 or 3) not aligned with the others, sometimes extending to between teeth 5 and 6 in primary series. Forewing marginal cell removed from wing-tip by about $0.8\times$ its own length (Figure 27). Metasoma as for *carbonarius*.

Measurements: see Appendix 1, Table 2.

Male. Length 3.5–7.0 mm; forewing 2.8–6.2 mm.

COLOUR AND VESTITURE. Similar to *carbonarius*; pubescence and hairs often slightly darker (silvery-bronze to pale bronzy fuscous); paraoccipital patch whitish; erect hairs pale bronzy-fuscous to black, never wholly black.

STRUCTURE. Head with malar space usually of moderate length, sometimes short ($0.05\text{--}0.13\times$ as long as antennal segment 2). Frons relatively swollen, particularly the apical half, which projects medially between antennal sclerites; entire frons bulging forward over clypeus; surface nowhere far removed from highest parts of antennal sclerites, nor depressed into a deep, wide sulcus between them (cf. *carbonarius*); mid-frontal line usually impressed for a short distance at about its midpoint, elsewhere obsolete; frons with small, shallow, contiguous punctures which become indistinct on vertex; POL:OOL about 1:2. Thorax with small, shallow, contiguous punctures. Fore femur without

spines; middle and hind femora with minute apical spines low on outer side. Tibiae with small apical spines. Subgenital plate (Figure 54a,b) short, squat, very broad, apically decurved, notched medially, evenly covered with short setae, but without long, fringing, lateral setae. Genitalia very similar to those of *carbonarius*, but when viewed from the side with the paramere much more slender, and lacking any notch or prominent hump midway along the ventral margin (see Key-figure 10b, cf. 10a).

Variation. Colour and vestiture are almost constant, but there is structural variation. The dorsal teeth on the female hind tibia, although always large and in the form of transverse, semilunar scales, are variable, especially the more basal ones. Sometimes one or two pairs of roughly parallel basal teeth are joined. This variation does not appear to follow a pattern, and in some samples (e.g., from Renata, southern Tararua Range), no two individuals had the teeth appearing almost exactly alike.

There is considerable variation in most of the ratios used. In many specimens submarginal cells 2 and 3 are almost equal in length, but in some cell 2 is larger than cell 3, and in others 3 is larger than 2. Throughout most of the North Island, the northern part of the South Island, southern Southland, and on Stewart Island the malar space is moderately long. However, in central and eastern Otago (south of Shag Point, the Horse and Kakanui ranges, and the upper Waitaki River; east of most of Fiordland; and north of the Takitimu Mountains and the Taringatura and Hokonui hills) almost all specimens have the malar space very short, so that the eye almost reaches the base of the jaw.

The male genitalia and subgenital plates are relatively constant.

FINAL-INSTAR LARVA

Diagnosis. Very similar to *P. carbonarius*, but with only 1 lateral seta on mandible, and apical margin of median labral lobe produced at about midway into an acute point. (Note. These characters were reliable for separating the limited material available. However, it is possible that the labral condition lies within the range of variation for both species, and unusually large specimens may have two mandibular setae.)

Description (based on a specimen from Leith Saddle, Dunedin, DN, 13 Mar 1972). Length 9.0 mm; maximum width 2.8 mm.

Body slender, fusiform, much more swollen towards posterior end; supra-anal lobe larger and more prominent than suranal lobe; anus situated lower than midway on anal segment. In most respects very similar to *P. carbonarius*.

Spiracles. First thoracic spiracle (Figure 96a): atrium with rim circular; maximum diameter 30 μm ; internal ridges branching more-or-less regularly; at $\times 400$ small spines apparent on only the 2 distalmost ridges. Collar spines sparse. Subatrium much narrower than atrium, with 5 or 6 rows of irregular pockets bearing on the inside a few teeth. Area immediately beyond subatrium dilated, 1.5 \times maximum diameter of atrium, proximally constricting gradually to about diameter of atrium at its junction with trachea. (This area is not expanded in all specimens. Note that the weak taenidial strengthening may permit variable rates of expansion in relation to body movement.) Abdominal spiracles each with subatrium and trachea proximal to it much narrower than atrium.

Head (Figure 118): width 1.0 mm, maximum height (excluding labrum) 0.57 mm; with 4 weak, rectangular impressions arranged transversely on frons between parietal bands above level of antennal orbits. Parietal bands very weakly pigmented. Antennal papilla (Figure 127) long — more than 0.29 \times maximum diameter of antennal orbit; length (excluding apical sensillae) 25 μm , apical sensillae 8.8 μm long; maximum diameter of antennal orbits 85 μm . Setae on vertex and temples relatively long; longest head seta (on gena) 42 μm ; LS/OD more than 0.49. Mandibles (see Figure 118) bidentate (not counting apex as a tooth), with 1 lateral seta; length 390 μm , width 250 μm ; ML/MW 1.56. Clypeus (see Figure 118) with a shallow, wide, median impression and 6 setae arranged medially on either side in groups of 3. Labrum (Figure 136) with 10 setae and 10 submarginal, pigmented sensory cones; width 340 μm ; lateral lobes well separated medially by a wide sulcus similar to that in *carbonarius*. Median lobe convex, its apical margin unevenly pointed. Epipharynx (Figure 147) with scales and sensillae similar to those of *carbonarius*. Labium and maxillae (Figure 165): maxillary palp 50 μm long; galea 55 μm long; lacinial area similar to that of *carbonarius*. Spinneret 125 μm wide; labial palpi 30 μm long. Spinneret setae as in *carbonarius*.

Variation. Little variation was evident in the two other specimens dissected, except that both lacked an expanded area at the inner end of the spiracular subatrium (Figure 96b).

Type data. **Holotype** female and **allotype**: New Zealand, WN, southern Tararua Range, Renata Hut, 12 February 1972, A. C. Harris (NZAC). **Paratypes**: all specimens collected by A. C. Harris are designated as paratypes, viz 985 females and 491 males from the following localities. TO – Mt Tongariro. WN – Renata Hut, Tararua Range; Akatarawa Saddle. NN – Mt Arthur Tableland,

1128 m. BR – above Rough Creek, Maruia Springs. WD – Kelley Creek, Otira; Lake Paringa; Glitter Burn at Haast River. MC – Little River, Banks Peninsula. OL – Te Anau. CO – Dansey's Pass; Naseby; Mt Swinburn; Taieri Ridge; Kokonga; Rock and Pillar Range; Pisa Range; Old Man Range; Obelisk Range; Hector Mountains; Rough Ridge; Dunback. DN – Leith Saddle, Dunedin; Flagstaff Hill, Dunedin; Dunedin Botanic Gardens; Waipori Falls. FD – Mt Luxmore; Manapouri; Homer Tunnel. SL – Blue Mountains. SI – Garden Mound; Lee Bay; Port William; Christmas Village; Mt Anglem, 1000 m.

Material examined. Type series, plus 267 non-type adults (183 females, 84 males) from at least as far north as Mangatepopo Road, Tongariro (latitude 39°05'S) to Garden Mound, Stewart Island (46°42'S). Also 9 larvae from Leith Saddle (DN) and Obelisk Range (CO). Collection localities: see Text-figure 9.

Collected from 3 m above sea level to at least 1525 m (The Remarkables, CO).

Adult females were recorded from November to April, and were most abundant in December and January. Adult males were present from November to January, and were most abundant in December.

Biology. HUNTING. Diurnal, errant spiders are often chased, then leapt at and stung repeatedly in the abdominal venter and then the prosomal venter. Immobilised prey is either hidden or left exposed before the wasp runs away to inspect its nest (multi-celled nester) or to find a hole for a nest (single-celled nester). Spiders are dragged venter up, by a third coxal base, to within about 4 mm of the nest entrance, and left while the wasp enters the nest. It emerges and drags the spider in by the spinnerets. It remains with the spider for 3–4 hours before filling up the nest to the surface and disguising the entrance (single-celled nest) or filling in the cell tunnel (multi-celled nest).

Theft of prey is prevalent, and similar to that described for *P. carbonarius*, especially on still, warm, sunny days in the mountains, when large numbers of females are hunting.

PARALYSIS. Similar to *carbonarius* (q.v., p. 58).

PREY CARRIAGE. Spiders, even when smaller than the wasp, are grasped by the base of a leg, usually the coxa of a third leg, and dragged backwards, venter uppermost.

NIDIFICATION FORMULA. Nest – prey – egg – (cell) – closure; or prey – nest – egg – closure.

NESTS are made in clay banks and gently sloping clay surfaces, from sea level to over 1525 m. *P. crawi* sometimes digs nests in humus, in forest litter in sunny places, and in exposed clay. Fre-

quently the burrows of native bees and tiger beetles are used. Sometimes, however, entire nests (including main burrows) are dug by *crawi*. A horizontal-floored recess is first excavated, from which a cylindrical, almost vertical burrow is constructed. On Flagstaff (DN), in clay, one female took 3.5 hours to dig a burrow 15 mm deep by 3.2 mm wide, using the apex of the abdomen and the forelegs, but not the mandibles.

Both single-celled and multi-celled nests are made. Single-celled nests (Figure 191) resemble those described for *carbonarius*.

Multi-celled nests (Figure 192). Twenty-three nests at Leith Saddle, Dunedin, were made in cylindrical native bee burrows 4–6 mm wide, blocked off with a plug of compacted soil below the level of the pompilid cells. The cells and cell burrows were dug entirely by the wasp. The first and second cells were 20 mm below surface level. There were 5–10 (7) cells, measuring 7.7–8.2 mm wide by 11.7–12.2 mm long, and connected to the main burrow (original burrow) by a 3-mm-long cell burrow. Each cell was sealed with a plug of compacted soil after oviposition. The main

burrow and external entrance to the nest were left open at all times throughout the season.

From the same site, seven nests in burrows of the colletid bee *Leioproctus monticola* (Cockerell) were dissected. These comprised 6–9 (7) pyriform cells, 11.8 mm long by 8 mm across, each connected to the main burrow (bee burrow) by a 3-mm-long cell burrow that was filled with compacted earth after oviposition. The first two cells were 20–24 mm below the surface entrance. Below the level of the last cell, the lower part of the bee burrow was blocked off with a plug of compacted soil. These nests were not shared with bees. However, in the Dunedin Town Belt eight nests of the halictid bee

Text-fig. 9 Distribution of collection localities, *Priocnemis crawi*.

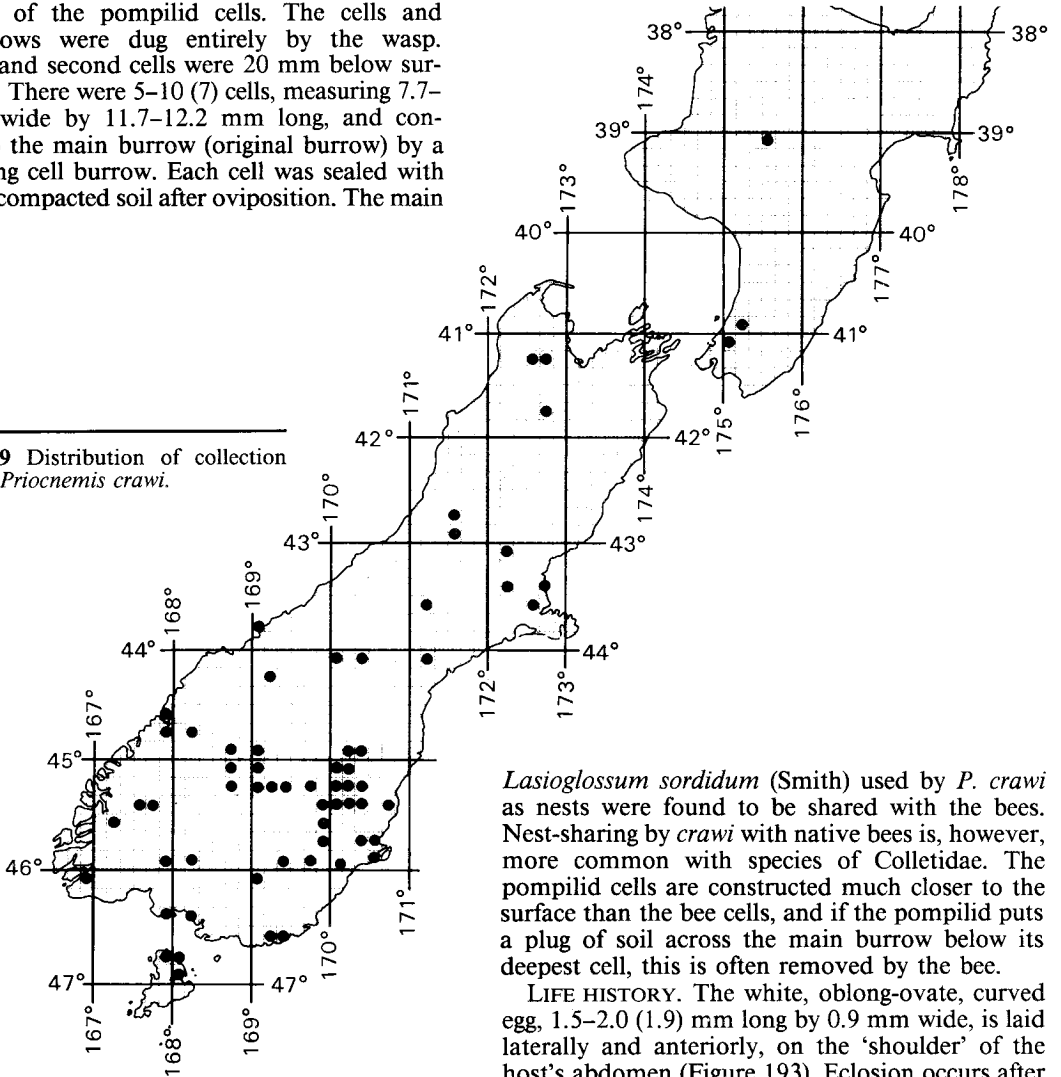

Lasioglossum sordidum (Smith) used by *P. crawi* as nests were found to be shared with the bees. Nest-sharing by *crawi* with native bees is, however, more common with species of Colletidae. The pompilid cells are constructed much closer to the surface than the bee cells, and if the pompilid puts a plug of soil across the main burrow below its deepest cell, this is often removed by the bee.

LIFE HISTORY. The white, oblong-ovate, curved egg, 1.5–2.0 (1.9) mm long by 0.9 mm wide, is laid laterally and anteriorly, on the 'shoulder' of the host's abdomen (Figure 193). Eclosion occurs after

3 days, instar 5 is attained 30 days later, and cocoon spinning begins after a further 4 days and finishes about 2.5 days later (field conditions, 2200 m). Pre-pupal diapause lasts about 6.5 months, and *P. crawi* is consequently univoltine.

Cocoons (Figure 209) are rigid, subpyriform, cinnamon-brown, and 6–9 (7.9) mm long. The wall is 0.055 mm thick, and its thickness divided by the width of the cocoon at the middle is 0.01. Other features are as in *P. carbonarius*.

Remarks. Outside central and eastern Otago, females of *P. crawi* are most readily distinguishable from *P. carbonarius* females by their moderately long malar space. In central and eastern Otago, *crawi* females are distinguishable by the hind tibia having large, wide teeth and two basal rows of small teeth; the ocelli with OOL about twice POL; and the vertex appearing smooth, highly polished, and jet-black. These characters, though somewhat variable in small populations, when taken together are relatively constant throughout the entire range of this species.

Males can be identified on the basis of any one of three characters: frons gibbous between antennal sclerites; subgenital plate short, squat; and paramere in lateral view slender, gently and evenly attenuated, sub-cylindrical (rather than flat).

Genus *Sphictostethus* Kohl

Sphictostethus Kohl, 1884, pp. 37 and 47. Type-species *Pompilus gravesii* Haliday, by original designation; Chile.

Haploneura Kohl, 1884, pp. 37 and 47 [preoccupied]. Type-species *Haploneura apogona* Kohl, by original designation; Chile.

Haploneurion Kohl, 1884, p. 163 [new name for *Haploneura*].

Anapriocnemis Haupt, 1959, pp. 25–26. Type-species *Pompilus flavipes* Guérin, by original designation; Chile.

Chrysocurgus Haupt, 1937, pp. 127 and 134. Type-species *Sphex nitida* Fabricius, by original designation; New Zealand (“nova Hollandia”).

Diagnosis. Forewing with 2nd radiomedial cross-vein slanting obliquely; 3rd submarginal cell very large, much wider and deeper than 2nd submarginal cell, its shape characteristic (see Key-figure 6b). Forewing venation and cells extending relatively very close to wing apex; apical end of marginal cell separated from wing apex by less than half its own length. Intersection of median vein and 2nd recurrent vein markedly basad of midway on 2nd submarginal cell; median vein between 2nd recurrent

vein and 2nd radiomedial cross-vein inclined at a very steep angle. Wings often amber-tinted, frequently banded, sometimes brachypterous. Base of metasoma often petiolate or subpetiolate in both sexes. Female labial palpi and maxillary palpi long. Female prementum with a fascicule of long, apically curved bristles divided into right and left halves (Figures 15–17). Male metasoma usually with ventral projections on 5th or 6th sternum (6th sternum often with a median, apical, deltoid keel or a round, median, apical tubercle; 5th or 6th sternum often with lateral, keel-like projections). Male subgenital plate with a compressed lateral tubercle near its apical articulation with 8th sternum, never with long, erect hairs of the *Priocnemis* type. Male genitalia often with the digitus volsellaris complex, bilobed, often with the apical part bent inwards at 90°. Parameres often broad, with pegs on outer margin. Hind tibiae of females with dorsal row of teeth fully developed, vestigial, or absent; when absent, bristles, setae, and spines on femora, tibiae, and tarsi of all legs also reduced. Female 5th tarsal segments ventrally often without pre-apical setae.

LARVAE with very short setae on head and thorax; longest head setae often on labrum.

BEHAVIOUR. Prey, unless small, is dragged backwards, usually by base of a 3rd leg coxa. Legs of prey never amputated. Usually a single spider placed in each nest, though multi-celled nests also occur. Nests made in soil, or above ground in rotten logs or in holes of wood-boring beetles high in trees. Some species are mud-users, closing their cells with a plug of mud. Nests in soil usually single-celled; if multi-celled, then with flimsy partitions between cells, without a recognisable main burrow, without branching cell burrows having inner closures, and without a terminal spur.

Remarks. In New Zealand, *Sphictostethus* species are readily distinguishable as follows. ADULTS. Wings yellow, often with areas of brownish infuscation, often banded, always with the second radiomedial cross-vein slanting more than 24° from vertical, relative to wing axis (Key-figure 6b). Female always with a fascicule of long, apically curved bristles on prementum (Figures 15–17). Males either with or without projections on 5th or 6th sterna of metasoma (Key-figures 14 and 15); when projections absent, base of metasoma extremely petiolate, so in dorsal view sides appear concave sub-basally (*nitidus*, Figure 43). Propodeum often with dense, brassy pubescence almost completely obscuring colour of integument (*nitidus*, *fugax*). LARVAE with sparse, very short setae on head and thorax; longest head setae on labrum; longest head seta above labrum never longer than 0.35× diameter of antennal orbit.

Sphictostethus is a discrete, very well characterised genus restricted to the Southern Hemisphere, and is almost certainly monophyletic. The three New Zealand species are closely related to species in Chile and Tasmania. Besides the type-species mentioned in the generic synonymy (p. 63), the following extralimital species should be referred to *Sphictostethus*: *Calopompilus aliciae* Turner, 1914 and *C. xanthochrous* Turner, 1915, both from Tasmania; *Haploneurion minus* Kohl, 1905, *H. obscurus* Sielfeld, 1973, *Salius thaumastarius* Kohl, 1905, *Pompilus flaviceps* Guérin, 1830, and *Agencia xanthopus* Spinola, 1851, all from Chile; and *Priocnemis montrouzieri* Williams, 1945 from New Caledonia. Many of these affinities have been noted previously, e.g., by Janvier (1930) and Townes (1957). Townes, however, treated *Sphictostethus* as a subgenus of *Priocnemis*, included as well *Priocnemis pretiosa* Banks, 1933, and placed *Chrysocurgus* Haupt in the synonymy of *Chirodamus* Halliday. *Sphex nitida*, type-species of *Chrysocurgus*, shows all the generic characteristics of *Sphictostethus*, whereas *P. pretiosa* is a true *Priocnemis* species.

The type-species of *Sphictostethus*, *S. gravesii*, although brachypterous in the female, is very similar to the New Zealand species *nitidus*, *calvus*, and *fugax*. It has characters linking these three species with each other. The male subgenital plate is apically notched, and in structure closely resembles that of *nitidus*, as does the petiolate base of the metasoma. The digitus volsellaris is apically bent over as in *calvus* and *fugax*, and is likewise basally complex and bilobed. The parameres have four pegs in much the same position as those of *fugax*. The sixth metasomal sternum bears projections similar to those of the New Zealand species. *S. gravesii* females similarly resemble the New Zealand species, showing homologous specialisation of the labium and maxillae, with long palpi and a fasciculus of long, apically curved premental bristles. The female hind tibia bears a dorsal comb-row of prominent scales similar to those of *nitidus*. The wings, amber and with fasciae, have the second radiomedial cross-vein slanting and the third submarginal cell very large.

The New Zealand species in turn link the Chilean species *apogonum*, *minus*, and *obscurus* — which have brachypterous females and short pegs on the parameres of the male — with *xanthopus*, *flavipes*, and *thaumastarius*, which are fully winged and lack pegs on the parameres. The fully winged Tasmanian species *aliciae* and *xanthochrous* closely resemble the New Zealand species. Females have dorsal comb-rows on the hind tibiae as in *nitidus*, premental fascicules of long, apically curved bristles, and yellow-tinted wings with two fasciae and

with the submarginal cells very similar. Males bear a sharp, deltoid keel medially on the sixth sternum and show clear structural similarities in the genitalia and subgenital plates.

Sphictostethus has a number of characters reminiscent of the Pseudageniini (= Macromerini) or Auplopodini: e.g., the petiolate gaster, the fasciculus of long, apically curved premental bristles, and the sealing of nests and cells with plugs of mud (*fugax*); the absence of dorsal teeth on female hind tibiae and the reduction of bristles and setae on all legs (*fugax*, *calvus*); the carina on the terminal metasomal tergum for moulding mud (*fugax*); and the very thin-walled cocoon (*fugax*). Such similarities appear to have arisen through convergent evolution, with reduction in or loss of digging behaviour, nesting above ground (*fugax*, *calvus*), and use of mud to seal nests (*fugax*). Convergence with Auplopodini and genus *Dipogon* is very superficial. The produced petiole in *Sphictostethus* does not closely resemble that of *Auplopus*. *Dipogon* has comparatively short, rather stumpy legs, and the origin of the premental fasciculus of bristles is very different. *Sphictostethus* differs behaviourally as well, making predominantly single-celled nests, not amputating the legs of prey, and transporting spiders backwards by a third leg coxa, as against straddling spiders held by the spinnerets and running forwards (Auplopodini) or sideways (*Dipogon*). The distinctive sparse, short head setae of final-instar larvae of the three New Zealand species are in marked contrast to the numerous long head setae of larvae of *Dipogon* and *Auplopus* reported by Evans (1959b).

The Chilean species *Haploneurion minus* and *H. apogonum* make single-celled subterranean nests, *minus* dragging spiders into existing holes and making hasty, very flimsy partitions, and *apogonum* closing its cells more firmly (Janvier 1930). Evans (1958) stated that *Haploneurion* has the nidification formula prey – nest – egg. This is basically similar to the New Zealand species of *Sphictostethus*, and differs from the New Zealand *Priocnemis* (*Trichocurgus*) group of species, most of which make subterranean, multi-celled nests used in some species by several generations over a number of years.

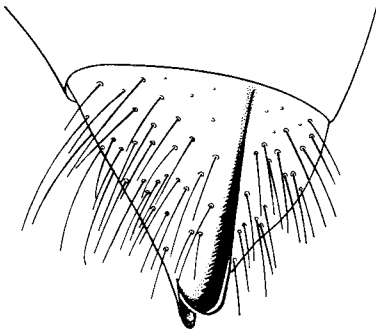

Key-fig. 12 Pygidium, dorsal, ♀, *S. fugax*.

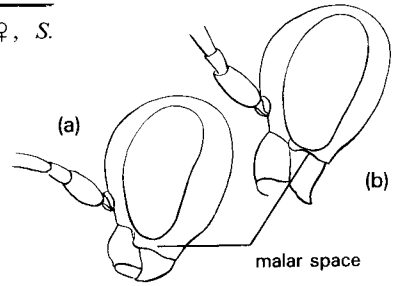

Key-fig. 13 Head, lateral, ♀: (a) *S. calvus*; (b) *S. fugax*.

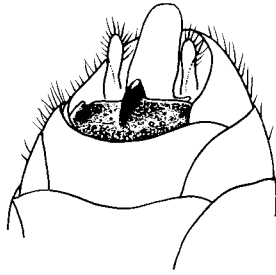

Key-fig. 14 Apex of metasoma, ventral, ♂, *S. fugax*.

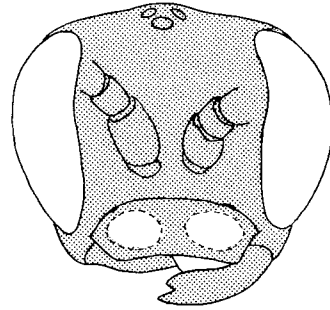

Key-fig. 16 Face, ♂, *S. calvus*.

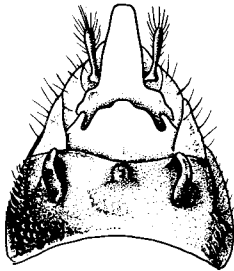

Key-fig. 15 Apex of metasoma, ventral, ♂, *S. calvus*.

KEY TO SPECIES OF *SPHICTOSTETHUS* KNOWN FROM NEW ZEALAND

ADULTS

- 01 Antenna with 12 segments; apex of metasoma without a prominent subgenital plate below, and with a sting which may be retracted ... FEMALES .. 02
- Antenna with 13 segments; apex of metasoma with a prominent subgenital plate below (e.g., Key-fig. 15) ... MALES .. 04

FEMALES

- 02(01) Hind tibia with 6–11 dorsal, scale-shaped teeth, numbers 3–5 (from base) very well developed (Fig. 35); propodeum with dense, brassy pubescence obscuring colour of integument; propodeum behind spiracle produced dorsolaterally into a very large, somewhat flattened tubercle, giving propodeum an almost hexagonal outline in dorsal view (Fig. 42) ... (p. 66) .. *nitidus*
- Hind tibia without well developed teeth; propodeum with or without brassy pubescence, never with a well developed tubercle behind spiracle ... 03
- 03(02) Propodeum without dense, brassy pubescence (colour of integument clearly visible); pygidium without a median, longitudinal carina; malar space moderately long (Key-fig. 13a) ... (p. 76) .. *calvus*

- Propodeum with dense, brassy pubescence virtually obscuring colour of integument; pygidium with a sharp, median, longitudinal carina (Key-fig. 12); malar space short, 0.03–0.21× as long as antennal segment 2 (Key-fig. 13b) ... (p. 84) .. *fugax*

MALES

- 04(01) Sixth metasomal sternum bearing medially a single, prominent, sharp, deltoid keel (Key-fig. 14) (p. 84) .. *fugax*
 - Sixth metasomal sternum without a prominent median keel ... 05
- 05(04) Metasoma without projections on first 6 sterna; 1st segment of metasoma very markedly petiolate, its sides sub-basally concave when viewed from above (Fig. 43); apex of subgenital plate deeply notched (Fig. 55); clypeus without a conspicuous, rounded, pale yellow spot on either side ... (p. 66) .. *nitidus*
 - Fifth metasomal sternum with a large, curved, deltoid projection on either side near lateral margin (Key-fig. 15); 1st segment of metasoma not markedly petiolate; apex of subgenital plate not deeply notched (Fig. 56); clypeus with a conspicuous, rounded, pale yellow spot on either side (Key-fig. 16) ... (p. 76) .. *calvus*

FINAL-INSTAR LARVAE AND PREPUPAE

- 01 Spiracle without small spines on anastomosing ridges lining atrium (Fig. 104); labrum with fewer than 14 setae and fewer than 14 pigmented, submarginal sensory cones (Fig. 139); cocoon pale buff, flimsy; larva above ground, e.g., in an old beetle tunnel in wood ... (p. 84) .. *fugax*
 - Spiracle with small spines (visible at ×200) on all anastomosing ridges lining atrium (e.g., Fig. 105); labrum with 16 or more setae and 16 or more pigmented, submarginal sensory cones (Fig. 137, 138); cocoon brown, rigid; larva below ground, or in rotting wood ... 02
- 02(01) LS/OD (length of longest head seta over diameter of antennal orbit) about 26; larva in soil or under stones, concrete, etc... (p. 66) .. *nitidus*
 - LS/OD about 36; larva in rotting wood ... (p. 76) .. *calvus*

Sphictostethus nitidus (Fabricius) new combination

- nitida* Fabricius, 1775, p. 351, no. 28; 1781, p. 449, no. 39; 1787, p. 276, no. 45; 1793, p. 63 (*Sphex*). Gmelin, 1790, p. 2731, no. 66 (*Sphex*). Christ, 1791, p. 291 (*Sphex*). Townes, 1957, p. 11 (*Chirodamus*). Walker, 1984, p. 57 (*Priocnemis*).
- nitidus* Fabricius, 1798, p. 250, no. 25; 1804, p. 195, no. 36 (*Pompilus*). Dalla Torre, 1897, p. 245 (*Salius*). Haupt, 1937, pp. 127 and 134 (*Chrysocurgus*). Williams, 1947, p. 326 (*Chrysocurgus*).
- fugax* not of Fabricius, 1775, p. 350, no. 27 (*Sphex*). Smith, 1855, p. 163, no. 223 (*Pompilus*). Sharell, 1971 and 1982, p. 182, pl. 195 (*Salius*) [illustration depicts *P. conformis*]. Laing, 1973, p. 58; 1975, p. 109; 1978, p. 76; 1979, pp. 1–21 (*Salius*).
- wakefieldii* Kirby, 1881, p. 39; 1884a, p. 68 (*Priocnemis*). Waterhouse, 1883, pl. 137 (*Priocnemis*). Dalla Torre, 1897, p. 245 (*Salius*).
- wakefieldi* Cameron, 1898, p. 47; 1903, p. 297 (*Salius*) [misspelling of *wakefieldii*]. Hutton, 1904, p. 97 (*Salius*). Hudson, 1914, p. 121; 1934, pp. 78 and 115 (*Salius*); 1950, pp. 45 and 57 (*Priocnemis*). Haupt, 1937, p. 127 (*Chrysocurgus*). Miller, 1971, p. 26, pl. 4 fig. 6 (*Salius*). Child, 1974, p. 92 (*Salius*). Laing, 1979, pp. 1–21 (*Salius*).

NOTE. Dalla Torre (1897, pp. 245–246) listed this species as *wakefieldii*, but in his synonymy twice gave only *wakefieldi* (incorrectly) as Kirby's (1881) original name. This error was repeated by all subsequent authors.

ADULT

Diagnosis. FEMALE. Head and metasoma reddish-brown. Wings tinted with yellow, apically infuscated; forewing throughout North Island below latitude 36°50' S (AK) variously spotted with infuscation, never with a distinct, transverse fascia; vein *3rm* not notably bent. First 3 antennal segments reddish, the 3rd sometimes infuscated apically. Prementum with a well developed fascicle of very long, apically curved setae. Hind femur with 2 small, very stout peg spines and 2 narrow ones very low on outer side at apex; middle femur with 1 apical peg spine. Hind tibia with a dorsal row of 6–11 teeth, of which numbers 3–5 (counting from base) form prominent, oblique ridges (Figure 35). Fifth tarsal segments with up to 13 well developed subapical spines on ventral surface. Propodeum with dense, golden pubescence, produced dorsolaterally into a large, sub-depressed tubercle giving propodeum a somewhat hexagonal outline in dorsal view. First segment of metasoma broadly convex. Pygidium without a dorsal, median, longitudinal carina.

MALE. Head and metasoma reddish-brown. Wings tinted with yellow; forewing sometimes with a small, transverse fascia, but cells otherwise never spotted with infuscation. Metasoma very notably petiolate; sides of 1st segment sub-basally concave when viewed from above. Venter of 6th sternite

(immediately basad of genital segment) without obvious medial or sublateral keels; subgenital plate with apical margin deeply notched (usually visible without dissection) (Figure 55).

Description. Female. Length 8.5–22.0 mm; forewing 7.5–19.0 mm.

COLOUR AND VESTITURE. Head, prothorax, and metasoma reddish brown, shining; hind part of thorax and propodeum reddish brown, or variously patterned with black (hidden by golden pubescence). Palpi, labrum, and proximal part of mandible reddish-brown; apex of mandible black. Antenna: scape reddish-brown; flagellum with infuscation, increasing gradually towards apex. Forewings hyaline, tinged with pale yellow-amber; veins amber, translucent; stigma deep amber, subopaque. A narrow, apical infuscation less than half as long as cell *3Rs* on both wings, and extending along anal margin of hind wings. Forewing with extensive infuscation in many cells on North Island specimens from south of AK; specimens from north of AK and throughout the South Island without subapical infuscation (see Variation, below). Distal part of mesepisternum, lateral portion of metapostnotum, and propodeum thickly covered with long, fine, recumbent golden hair. Pubescence brassy-golden; clypeus with long, erect, brassy-golden hairs; remainder of body very sparsely hairy except for the usual hairs on abdominal apex.

STRUCTURE. Head. Prementum with a fascicule of 32 long, curved bristles, divided into left and right groups, of which the basalmost 6 pairs are long, extending to galea (Figure 15). Maxillary palp relatively long, differing notably from that of *fugax* in having segments 3, 4, and 5 straight. Segment 3 not notably bowed; segment 4 shorter than in *fugax*, and almost straight. Malar space moderately long, about 0.10–0.27× as long as antennal segment 2. Clypeus with apex strongly emarginate, bearing a submarginal row of about 23 stout, erect setae. Frons shining, closely covered with small punctures; median frontal suture variable, often obsolete shortly forward of anterior ocellus, but deeply incised along its apical 0.6. Ocellar triangle very compact, its front angle less than 90°; POL:OOL about 7:3. Pronotum small, its posterior margin angulate. Thoracic dorsum with small punctures, as on frons; pleura with smaller, close, indistinct punctures. Mesoscutum large, with pre-scutal and parapsidal sutures; median scutal line absent. Posterior margins of metanotum and metapostnotum straight. Propodeum (Figures 40 and 42) with a median impressed line, produced dorsolaterally behind spiracle, about midway, into a large, somewhat flattened tubercle, giving propodeum a more or less hexagonal outline from above. Fore

femora without spines; apex of middle femur with a small, blunt spine anteriorly; apex of hind femur usually with a series of 4 small spines anteriorly (see Variation, below). Fore tibia with outer apical bristle vestigial; hind tibia with a dorsal row of 6–11 teeth, numbers 3–5 (counting from base) moderately developed, scale-shaped or ridge-shaped, the others small (Figure 35). Fifth tarsal segments with stout, pre-apical ventral spines, but only 1 ventral pair towards sides; claws dentate. Forewing, Figure 28; marginal cell removed from wing-tip by 0.48× its own length; vein *3rm* relatively straight (cf. bent in both *fugax* and *calvus*) (see Figures 29 and 30). First segment of metasoma not petiolate; tergite convex when viewed from above, and quite steeply convex in lateral view (Figures 40 and 42). Pygidium unspecialised, with the usual apical bristles and without modifications for manipulating mud.

Measurements: see Appendix 1, Table 3.

Male. Length 7.5–15.0 mm; forewing 7.0–13.0 mm.

COLOUR AND VESTITURE. Very similar to female, but antennal segments 1 and 2 reddish-brown, and the remainder fuscous brown, rather than gradually infuscate towards apex. Wings hyaline, tinged with yellow; veins pale amber, translucent; stigma fuscous-amber, opaque; apical infuscation extending across forewing at level of stigma. Frons dully shining, with decumbent, aeneous pubescence. Vertex with a few erect, infuscate setae.

STRUCTURE. Head. Clypeus with disc convex; apex emarginate, bearing a submarginal row of about 16 long, erect setae. Malar space moderately long (about 0.13–0.16× as long as antennal segment 2). Frons closely covered with indistinct punctures; frontal line often deeply and broadly sulcate from upper level of antennal sclerites to a point halfway to median ocellus. Pronotum short, its posterior margin angulate. Tarsal claws bifid. Forewing marginal cell removed from wing-tip by about 0.03× its own length. Subgenital plate broad, with a characteristic apical notch and an indentation on either side medially, with an associated deep groove into which sternite 8 fits (Figure 55). Genitalia: aedeagus simple; parapsidal lobes simple, rod-like, apically decurved; digitus volsellaris with apex clavate, inwardly curved, bearing small, thick, sharply pointed setae. Paramere thin, simple, its apical 0.3 reduced, suggesting a twist at point of reduction (Figure 64). Lamina volsellaris with 2 pairs of basal hooklets, the basalmost often weakly developed, so that some specimens appear to have only a single pair of hooklets (other specimens from the same area may have the basal pair fully developed).

Measurements: see Appendix 1, Table 3.

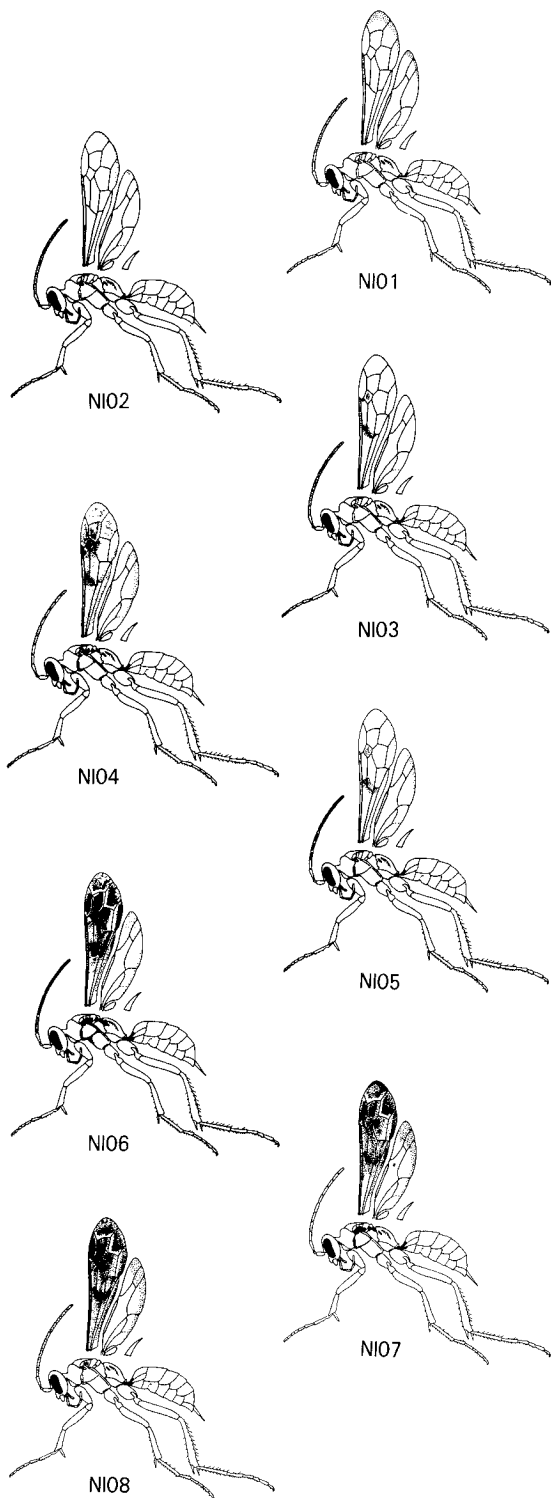

Variation. Structural variation is minimal, and apparent coloration is virtually constant throughout New Zealand. The head is always red, and the palpi are always pale reddish. Southern females from south of Dunedin (DN), and specimens from Kaitaia (ND), have the body and first 3 antennal segments completely reddish-brown.

Unlike the other New Zealand *Sphictostethus* species, *nitidus* shows no tendency towards southern melanism. Notwithstanding this, parts of the mesosoma are subject to environmentally induced melanism. Thus, the integument of the propodeum and mesopleuron below the transverse suture varies from reddish, through red and black, to entirely black. This variation is concealed, because the parts affected are mostly covered with dense, golden pubescence and appear golden in all specimens. The darkest individuals occur in the North Island form from the Tararua Range; South Island individuals from the southernmost limits of the distribution are notably paler.

There are three distinctive geographical forms (Text-figure 10). The disjunction between North Island and South Island forms involves 100% of individuals from all samples.

(1) South Island form (also present on d'Urville Island and Stephens Island in Cook Strait). FEMALE. Forewing without infuscation basal to 3rd radio-medial cross-vein; apical infuscation very small. A deep median furrow on frons immediately above antennal sclerites. MALE. Forewing without a fascia. Frons with a median impression above level of antennal sclerites.

(2) Central and southern North Island form (also present on Kapiti Island and Mana Island in Cook Strait, and on Great Barrier Island). FEMALE. Immediately recognisable by the infuscated forewing. Uneven darkening occurs on marginal cell, 1st, 2nd, and 3rd submarginals, 1st, 2nd, and 3rd medials, cubito-anals, and anal cell. Median frontal sulcus above antennal sclerites variable, in some specimens almost as well developed as in South Island samples, but in others obsolete. This range of variation is present in series taken at localities in Wellington (WN), at Kai Iwi (WI), and in other North Island localities. MALE. Forewing with a small fascia composed of darkened hairs on either side of medial vein and radial sector.

(3) Northland form. FEMALE. Specimens from north of Warkworth (AK; latitude 36°24'S) have the forewing devoid of pre-apical infuscation, as in the South Island form, and hence closely resemble

Text-fig. 10 (part) Selected, locally representative females of *Sphictostethus nitidus*; see map on p. 73.

southern individuals. However, the lack of a furrow on the frons immediately above the antennal sclerites in the Northland form readily distinguishes it. In some areas — e.g., Puketi Forest — females sometimes have a small fascia on either side of the median vein and the radial sector, similar to that in central and southern North Island males. **MALE.** Forewing without a fascia; frons without a median impression above level of antennal sclerites.

Hybrid zone: between Leigh (36°17'S) and Auckland City (36°51'S) forms intermediate between the Northland and southern North Island morphs occur, although at the latitude of Warkworth most females are quite without infuscation on the forewing, other than the narrow apical band present on all individuals of this species.

OTHER VARIATION. In females the apical femoral spines are variable, and abrasion can result in loss of spines. Sometimes there are three very stout spines on the hind femur, whereas in other, usually smaller specimens only one spine is stout, the remainder being slender.

TERATOLOGICAL ABNORMALITY. Two females from the Old Man Range (CO; 870 m, 2 Feb 1970) have the entire head capsule, thorax, coxae, trochanters, propodeum, and basal parts of the metasoma deeply rugose.

FINAL-INSTAR LARVA

Diagnosis. Head with setae on vertex and temples sparse, minute; longest head seta about 35 µm; LS/OD 26. Clypeus without a median sulcus or impression. Labrum subangulate, with 16–18 setae and 14 large, submarginal, pigmented sensory cones; median lobe with apical margin subrectilinear, appearing straight. Median area of epipharynx with widely spaced, small, blunt spinules not projecting far beyond apical margin. First thoracic spiracle with anastomosing ridges lining interior of atrium irregular, bearing conspicuous, small, blunt teeth.

Description (based on a specimen from Botanic Gardens, Wellington, WN, 1 Dec 1971). Length 17.0 mm; maximum width 4.0 mm.

Body (Figure 73) fusiform, more swollen posterior to middle; pleural lobes moderately developed; supra-anal lobe larger than suranal lobe; anus situated below middle of anal segment. Prothorax with dorsal setae ranging from small (38 µm) to minute (2 µm). Venter with sparsely scattered, minute spinules forming a regular pattern; spinules averaging

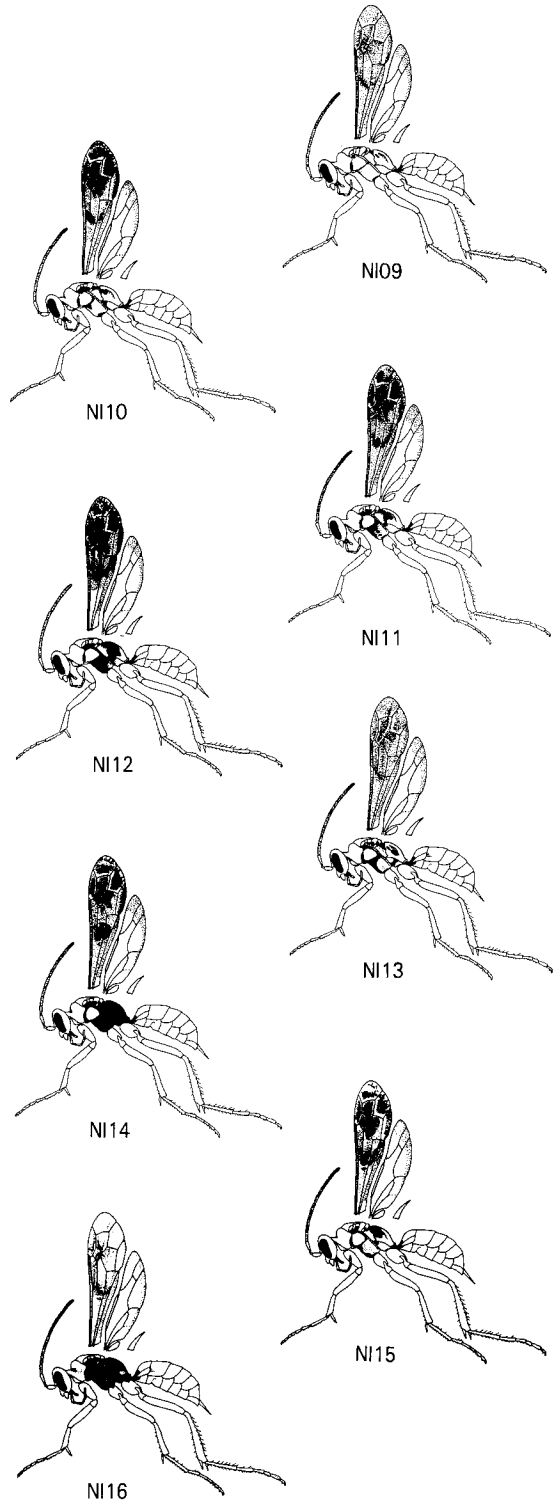

Text-fig. 10 (part) Selected, locally representative females of *Sphictostethus nitidus*; see map on p. 73.

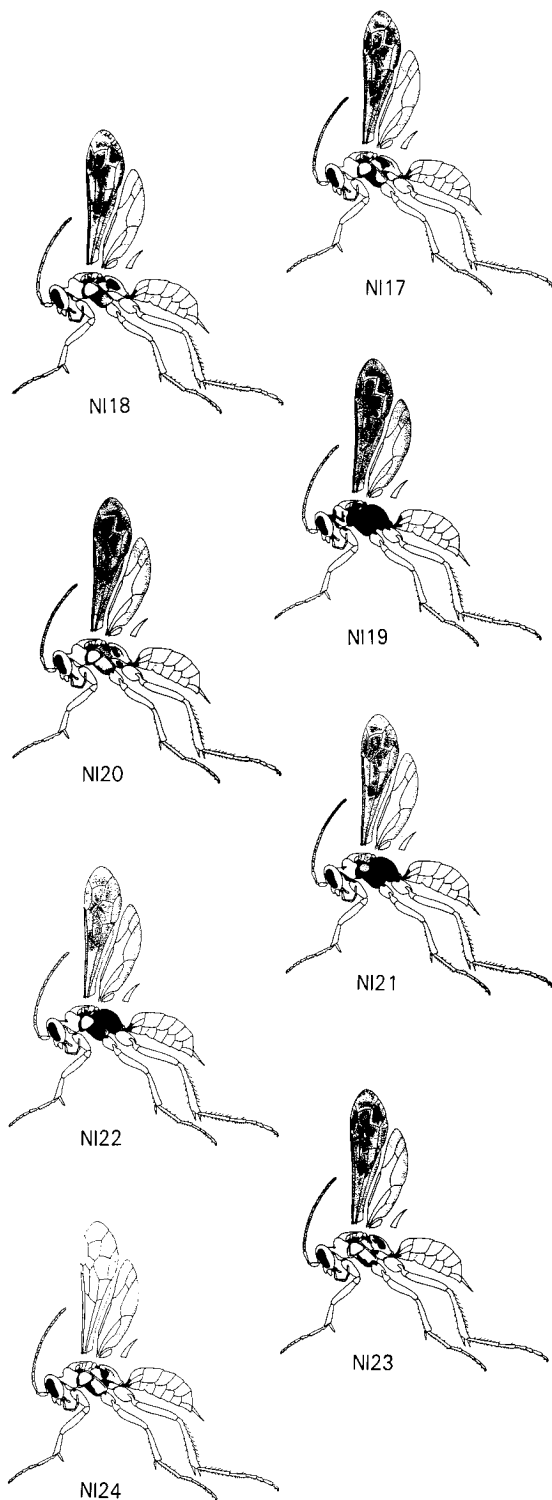

2 μm long in some areas and 3.5 μm in others, proportionately smaller than in other New Zealand species (Figure 85).

Spiracles small, pale yellow, circular. First thoracic spiracle (Figure 97a,b) 85 μm in diameter; atrium lined with anastomosing ridges that bear distinct, small, nodular spines (these spines larger than in any other New Zealand species except *P. monachus* and *C. australis*); cells bounded by atrial ridges irregular, some with a vertical protrusion; internal boundary of atrium with small, acicular spines; walls of subatrium thrown into about 5 rows of irregular folds, this region internally lined with grouped teeth; diameter of subatrium in distal, folded region slightly less than that of atrium; proximal to it a dilated, smooth-walled area is demarcated from the folded area by a sharp increase in diameter.

Head (Figure 119). Height (excluding labrum) 1.08 mm; maximum width 1.56 mm; HW/HH 1.44. Parietal bands very long, narrow, moderately pigmented; pigmented lines extending 119 μm below antennal orbits. Head setae sparse, those on temples and vertex very short; longest head seta 35 μm ; LS/OD 0.26. Four shallow depressions, each approximately 150 μm wide by 300 μm high, lying transversely between parietal bands, just above level of antennal orbits. Antennal papilla 36 μm long (excluding 8- μm -long apical sensillae) by 16 μm wide at mid length. Greatest diameter of antennal orbits 136 μm . Clypeus with 8 unequal setae, without a median sulcus or impression. Labrum (Figure 137): median height 136 μm (labrum usually contracted, in this specimen resulting in an apparent height of 68 μm), width 527 μm ; labrum with 18 transverse setae and 14 large, submarginal, pigmented sensory cones, neither cones nor setae rectilinear in arrangement; lateral lobes well separated medially, each lobe subrectangular in outline, its apex very slightly concave in middle; outer apical angle of lateral lobes subangulate, the margin unevenly rounded; median lobe well developed, its apical margin, though gently and evenly convex, appearing unusually rectilinear. Epipharynx (Figure 148a,b) with the usual rows of scales; lateral scales with 4–6 points, mesal ones single-pointed; median lobe apically with small, rounded, uncrowded scales; lateral lobes each with 6 clearly defined sensillae, the 2 apicalmost paired and conspicuous. Mandibles (Figure 156) 663 μm long by 374 μm wide; ML/MW 1.77; 2 lateral setae present. Labium and maxillae (Figure 166): maxilla with lacinial area produced, spinulose; maxillary palpi

Text-fig. 10 (part) Selected, locally representative females of *Sphictostethus nitidus*; see map on p. 73.

81 μm long by 51 μm wide at base; galeae 78 μm long by 36 μm wide at base; labial palpi 42 μm long by 26 μm wide; spinneret 280 μm wide, faintly emarginate apically, with 1 or 2 spinneret setae.

Variation. The arrangement of cones and setae on the labrum varies slightly. In the Wellington region it is common to find 18 setae, nine to each lobe, arranged in triplets, with the middle series on each lobe set back from the others. The number of setae on the labrum is also variable to a limited degree, and is related to body size, which varies greatly in *S. nitidus*. (Most of the dissected material was raised from the egg in the laboratory. I have found that such conditions frequently alter the development rates and size of solitary wasp larvae, and cause other variation such as a reduction in the number of labral cones.)

Type data. The type specimen was collected by Banks and Solander between 9 September 1769 and 30 March 1770. Unfortunately some mixing of material occurred during the voyage of the *Endeavour*, resulting in a few New Zealand species being erroneously described as from South America or Australia, and vice versa. Thus, Fabricius listed Australia as the type locality for his *Sphex nitida*, and Haupt (1937) and Williams (1947) stated that it occurs in Queensland, New Zealand, and the Fiji Islands. In fact it is not found outside New Zealand.

Fabricius's original description is quite unambiguous. However, Mr M.C. Day of the British Museum (Natural History) informs me that the type specimen has been lost, and that the specimen standing in the Banks Collection is a female of *P. conformis* (Smith), which he has therefore labelled "specimen *not type*". I conclude that the type specimen disappeared before 1855, because in that year Smith synonymised *nitida* with *P. fugax* Fabricius, stating (p. 163) that "On comparison, these insects in the Banksian Collection will be found to be the same". Furthermore, Kirby (1881), though identifying *fugax* correctly and recognising that Smith's synonymy was incorrect because Fabricius's names *fugax* and *nitida* represented different insects, nevertheless did not recognise some specimens of *nitida* sent to him by Wakefield, for which he created instead the nominal species *wakefieldii*. These specimens, collected in Christchurch, are of the distinctive South Island form.

Mr M. C. Day informs me that *P. wakefieldii* is represented in the BMNH collections by a series of 47 specimens, of which seven are old enough to

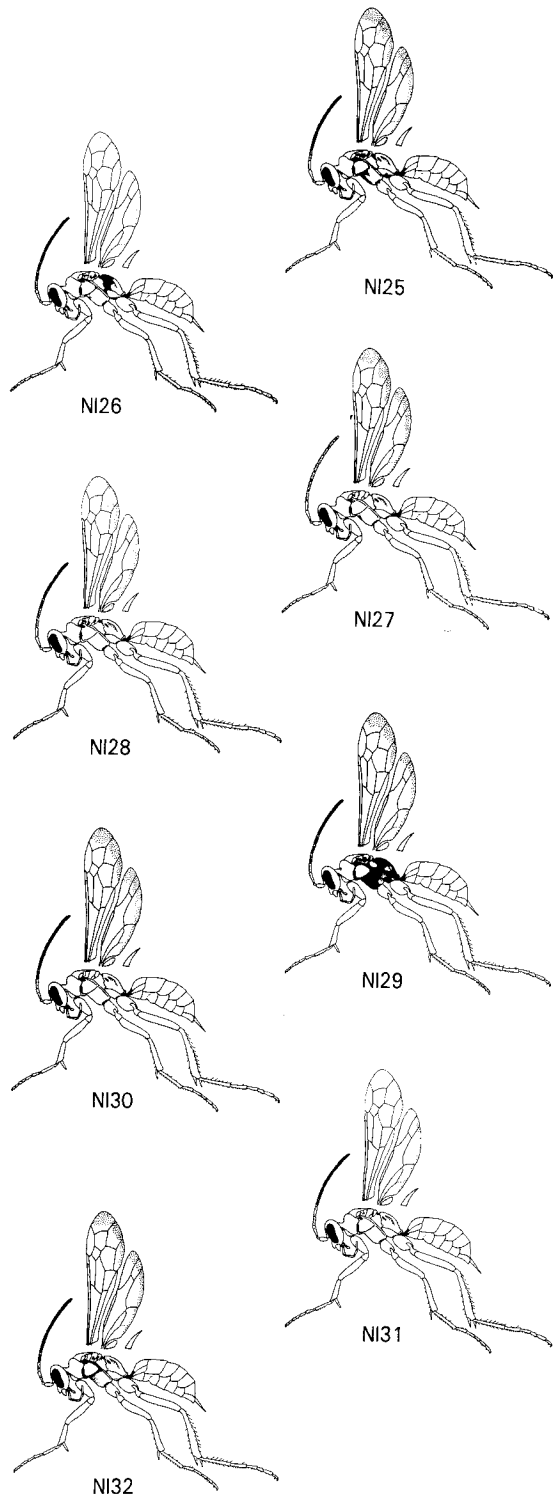

Text-fig. 10 (part) Selected, locally representative females of *Sphictostethus nitidus*; see map on p. 73.

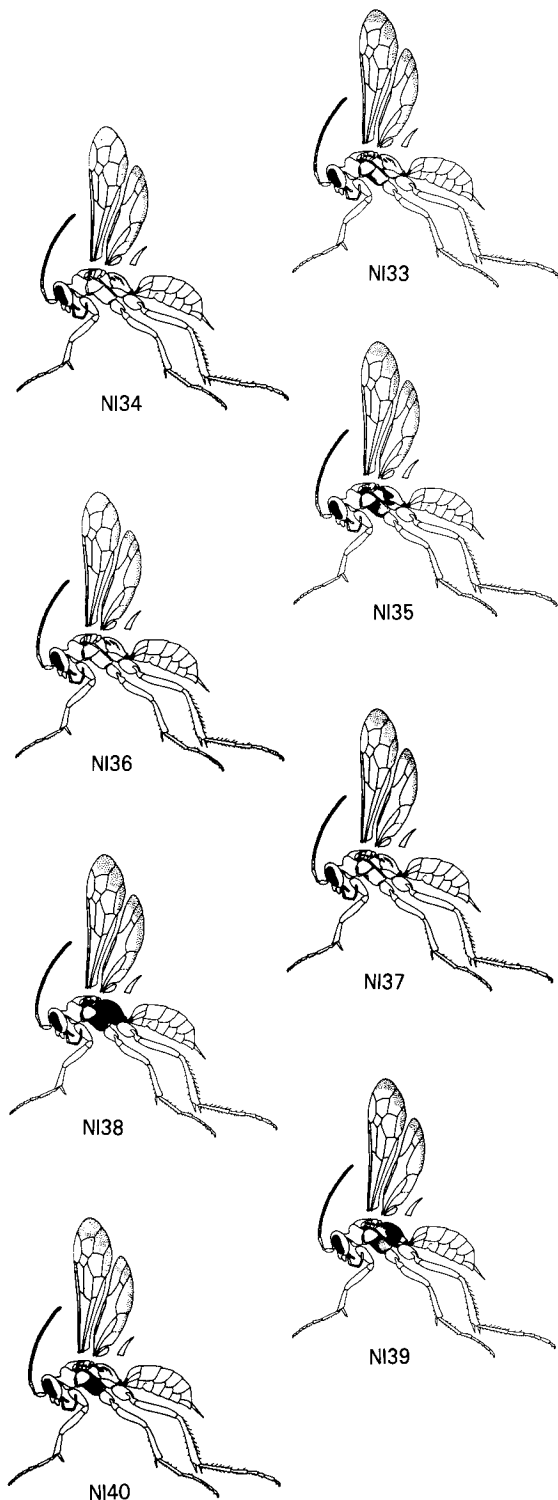

have been seen by Kirby in 1881. Of these, two females and a male were presented by Wakefield, and are listed in the accessions register as "*Priocnemis fugax*". These three specimens are thus syntypes of *P. wakefieldii*, and a lectotype designation is necessary. Therefore, one female selected by Mr Day and examined by me is here designated as the lectotype; the remaining female and male are paralectotypes.

nitida Fabricius: **holotype** female, "nova Hollandia" [in error; actually collected in New Zealand], J. Banks and D. C. Solander; lost.

wakefieldii Kirby: **lectotype** female, South Island colour-morph, New Zealand, C. M. Wakefield (BMNH, Banks Collection); **paralectotypes** (1 female, 1 male, South Island colour-morph), same data as lectotype. Lectotype female with 3 attached labels. The first label is 11 mm long by 5 mm wide, buff, bearing in black printed letters the words "N. Zealand"; on the back is hand-written in black ink "7h - 20". The second label is a white, circular disc, 8 mm in diameter, with a 1.5-mm-wide purple margin, bearing in black, printed capitals the word "LECTOTYPE". The third label is an oblong white card, 22 mm long by 10 mm wide, bearing in black ink the writing "LECTOTYPE ♀ *Priocnemis wakefieldii*, Kirby". Paralectotype female with 3 attached labels. The first label is oblong, 11 mm long by 5 mm wide, buff, bearing in black, printed letters the words "N. Zealand"; on the back, in black ink, is hand-printed "7h - 211". The second label is a white, circular disc, 8 mm in diameter, with a 1.5-mm-wide powder-blue margin, bearing in black, printed capitals the word "PARALECTOTYPE". The third label is an oblong, white card, 22 mm long by 10 mm wide, bearing in black ink the handwriting "PARALECTOTYPE ♀ *Priocnemis wakefieldii* Kirby". Paralectotype male with 3 attached labels. The first label is oblong, 11 mm long by 5 mm wide, buff, bearing in black, printed letters the words "N. Zealand"; on the back, hand-printed in black ink, is "7h - 20". The second label is a white, circular disc, 8 mm in diameter, with a 1.5-mm-wide powder-blue margin, bearing in black, printed capitals the word "PARALECTOTYPE". The third label is an oblong, white card, 22 mm by 10 mm, bearing in black handwriting "PARALECTOTYPE *Priocnemis wakefieldii* Kirby".

Material examined. Lectotype and paralectotypes of *wakefieldii*, plus 1448 non-type adults (855 females, 593 males), 55 larvae, and 47 pupae from at least as far north as Kaitaia (ND; latitude

Text-fig. 10 (part) Selected, locally representative females of *Sphictostethus nitidus*; see map on p. 73.

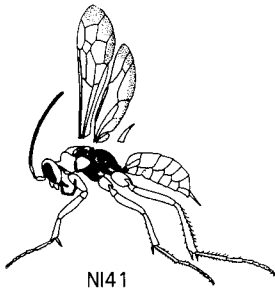

NI41

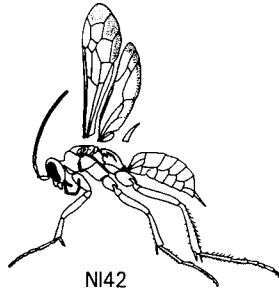

NI42

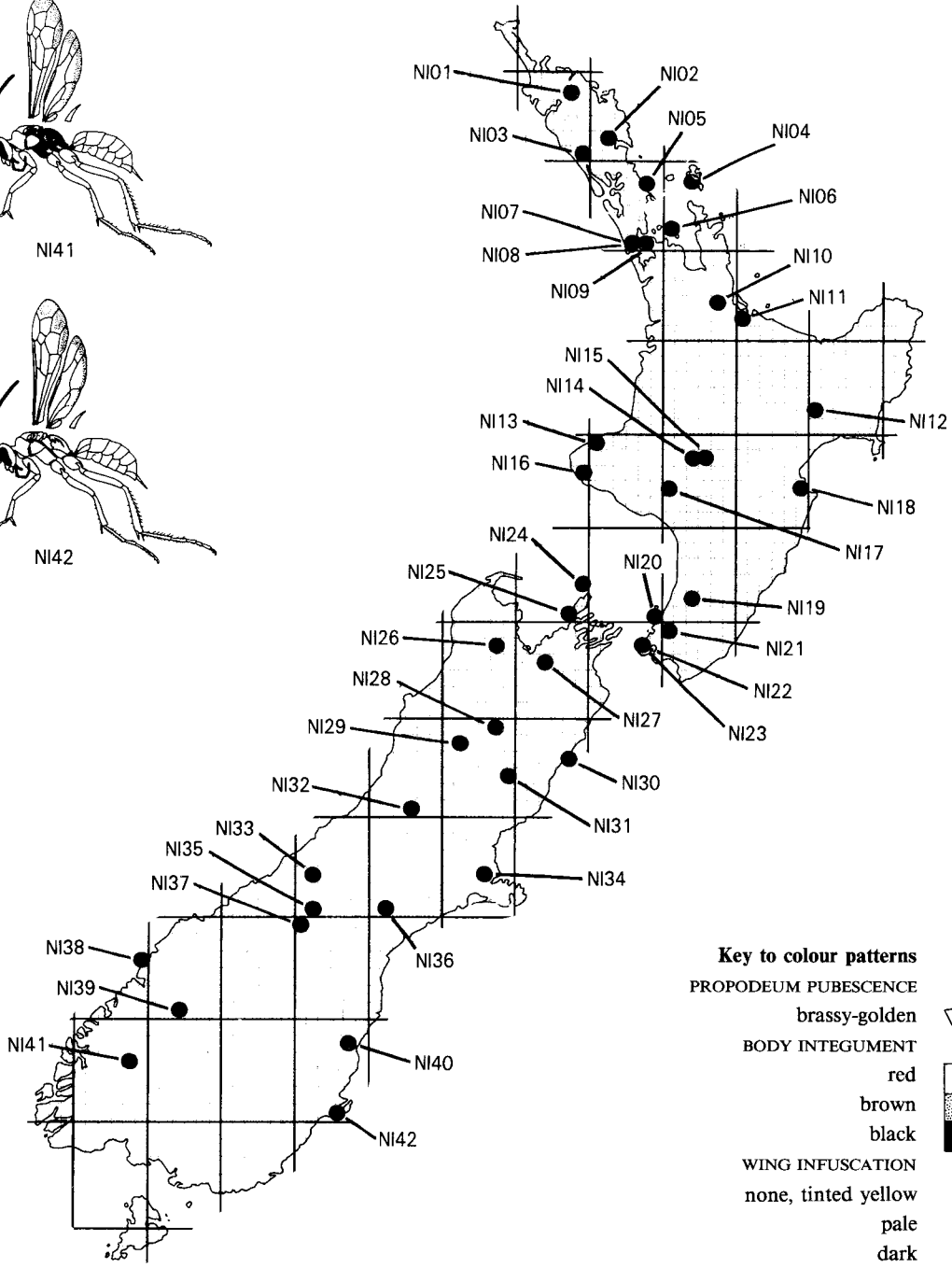

Text-fig. 10 (part) Selected, locally representative females of *Sphictostethus nitidus* and their place of origin.

35°07'S) to the Waiau River (SL; 45°35'S) and Woodside Glen, Dunedin (DN; 45°51'S). The geographical races were represented as follows. Northland form - 79 adult females, 31 adult males. Central and southern North Island form - 362 adult females, 314 adult males, 43 larvae, 38 pupae. Intermediates between the above two forms - 12 adult females, 2 adult males. South Island form - 302 adult females, 246 adult males, 12 larvae, 9 pupae. Collection localities - see Text-figure 11.

Taken from sea level to at least 1400 m (Mt Binsler, NC).

Adult females were recorded from October to March, and were most abundant from December to February. Adult males were recorded from September to February, and were most abundant from November to January.

Biology. HUNTING. *S. nitidus* hunts on the ground (beneath and in logs, debris, and rotting wood) and in foliage, including the crowns of shrubs and bushes; on shingle (e.g., in river beds) it hunts under boulders. Spiders are usually detected visually and chased into the open. The method of attack varies with the species and size of spider. When *Miturga*

Text-fig. 11 Distribution of collection localities, *Sphictostethus nitidus*.

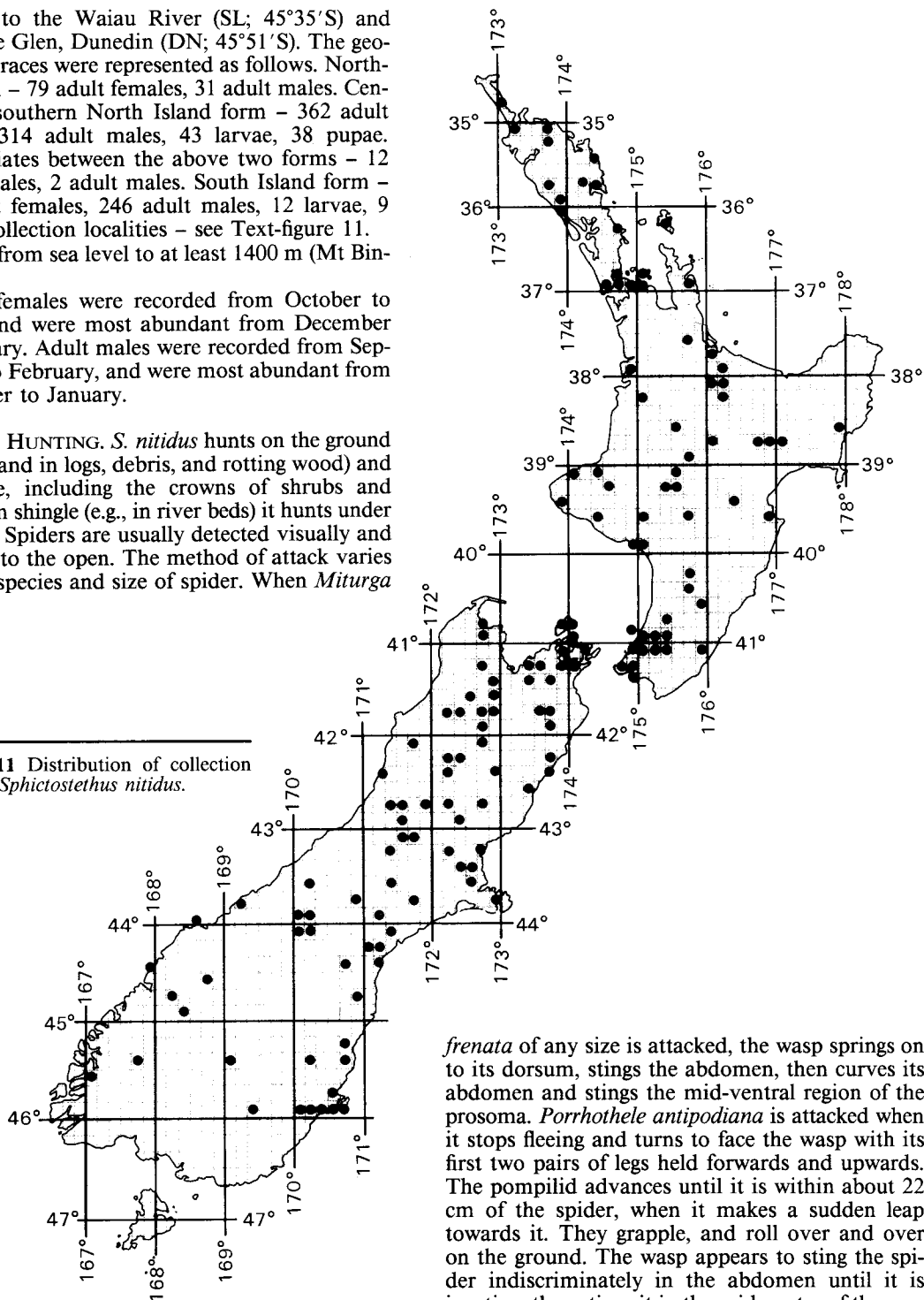

frenata of any size is attacked, the wasp springs on to its dorsum, stings the abdomen, then curves its abdomen and stings the mid-ventral region of the prosoma. *Porrhothele antipodiana* is attacked when it stops fleeing and turns to face the wasp with its first two pairs of legs held forwards and upwards. The pompilid advances until it is within about 22 cm of the spider, when it makes a sudden leap towards it. They grapple, and roll over and over on the ground. The wasp appears to sting the spider indiscriminately in the abdomen until it is inactive, then stings it in the mid venter of the prosoma, and then between the chelicerae. It then

examines the spider's mouthparts and stings it again at the base of the chelicerae. Finally, it brushes the tip of its own abdomen with alternate strokes of the entire hind tibia and tarsus for 3–8 minutes.

S. nitidus steals spiders from members of its own species, and others, including *P. monachus* (21 observations).

PARALYSIS of spiders is permanent.

PREY CARRIAGE (Figure 175). Spiders are grasped by the base of a leg, usually the coxa of the third leg, and dragged backwards, venter uppermost.

NIDIFICATION FORMULA. Prey – nest – egg – closure, or nest – prey – egg, or nest – prey – egg – (cell) – closure.

DIGGING. *S. nitidus* is disinclined to dig, and I have never observed appetitive digging of a series of holes in the manner of *conformis* and *nitidiventris*. It sometimes widens crevices beside partly buried logs and boulders, but generally it does not construct burrows away from pre-existing holes or solid surfaces. In captivity, *nitidus* digs by widening existing crevices.

NEST (Figures 194–196). After paralysing a spider, *nitidus* either takes it to a place of temporary storage (18 observations) or leaves it exposed, venter uppermost (13 observations). It then either returns to the nest site or locates a suitable nest. Frequently it examines several potential sites, returning to the spider at intervals. The wasp then drags the spider to the nest, leaves it 25 mm from the entrance, and goes inside; it then re-appears and drags the spider in by the spinnerets. Sometimes it waits in the cell, under the spider, for 2–26 hours before ovipositing. After oviposition it pauses for 15 minutes to 2 hours (in the case of single-celled nests in burrows) before filling the burrow right up to the entrance with manuka leaves and berries, stones, twigs, fragments of bark, grass, twigs, broken pine needles, or fragments of moss and dried lichen, using material from 5 mm to 56 mm in length. These fragments are picked up in the mandibles and dropped into the nest. The wasp then backs around and rams them firmly into place with the apex of the abdomen, pushing sideways and backwards as well as downwards (Text-figure 12). When the nest is fully closed, *nitidus* disguises the entrance by dragging pieces of bark and twigs across, examines the site from several directions, and then re-arranges a few twigs. After examining the site once more, it leaves. Nest closure takes on average 1.75 hours.

Both single-celled and multi-celled nests are made, and nest architecture varies widely.

Multi-celled nests (Figure 194). Cells do not branch from a common, cylindrical main burrow, as for instance with *P. monachus* and *P. carbonarius*. Rather, they are often unconnected, being

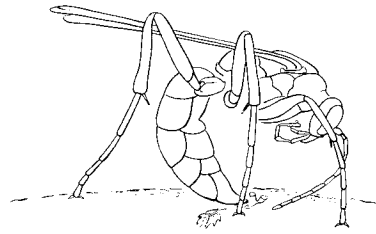

Text-fig. 12 *Sphictostethus nitidus* smoothing filling of single-celled nest.

grouped discretely at varying distances under the same stone. Some cells, made beside walls, have independent surface entrances and are filled from just above the spider to the surface with compacted plant material. Although such cells, made by the same individual, are contiguous they can only be regarded as single-celled. Under concrete, large flat stones, etc., cells are very shallow and varying distances apart. If, however, the large space often present between stone and ground is regarded as a 'main burrow', then these nests could be called multi-celled. Other cells under stones are connected by an excavation made by the wasp, and are thus clearly multi-celled. Nest no. 87, in a clay hillside near Waiānākara Scenic Reserve (DN) is typical. A flat, triangular stone, 254 mm long by 155 mm across, had five cells beneath it constructed by a single *S. nitidus*. The cells were 5–10 mm deep by 5.8 mm wide, and the legs of the spiders (all *Dolomedes minor*) projected 2–4 mm above the entrance of every cell. None of the cells was sealed. Similar nests beneath stones elsewhere had 3–9 cells.

Single-celled nests (Figure 196) are made typically in soil, in abandoned insect pupal chambers and cicada burrows. Such nests in Wellington's Botanic Gardens and in the Tararua Range were in vertical holes, 9–22 mm wide and 52–62 mm deep. The spider was placed at the bottom, and the space above was filled to the surface with pieces of grass, leaves, twigs, small berries, dried lichen, stones, and bark. Nests are closed with plant material even when they occur in exposed clay. After the nest is filled, the surrounding ground and the entrance are disguised. (Of 97 nests dissected, 76 were of this single-celled type — partly a reflection of the difficulty of examining nests under concrete.)

LIFE HISTORY. The creamy-white, oblong-ovate, slightly curved egg, 2.5 mm long, is glued along its side to the anterolateral part of the host's abdomen (Figure 196). In the laboratory at 22°C egg eclosion occurs after 3 days; 35 hours later the larva moults

into instar 2; 41 hours later into instar 3; and after a further 31 hours into instar 4. It moults into instar 5 on the ninth day, and begins cocoon-spinning on day 11. It takes 2 days to spin the cocoon, and the meconium (waste matter) is excreted halfway through the third day. Development from oviposition to spinning of the cocoon takes 9 days at 22°C in the laboratory; it took 14 days in the field at 700 m in the southern Tararua Range (WN) during February 1972. *S. nitidus* is univoltine, and prepupal diapause lasts about 7 months.

The subterranean cocoons (Figure 210) are subpyriform, truncate at the narrow (meconial) end, rigid, opaque burnt sienna to raw umber in colour, and 16–28 (18.6) mm long; the walls (Figure 214) are on average 0.06 mm thick. The thickness of the wall divided by the width of the cocoon at the middle is 0.01.

EMERGENCE AND COPULATION. Males emerge 3–8 days before females. Copulation usually occurs above ground, often on foliage, sometimes on the crowns of shrubs and bushes. The males, running over leaves, fluttering, darting, moving this way and that, pursue any females that appear. A receptive female is mounted, and the short copulation begins. Frequently other males climb on top of the mating pair.

HABITAT. Although showing a preference for open, exposed places, *nitidus* tolerates a wide range of habitats. It has adapted very well to environmental changes brought about by European settlement, and is common in suburban back yards, on coastal foredunes, dry riverbeds, clearings in forest, long grass, and clay banks. It nests from sea level to at least 1370 m, in sand, clay, humus, debris, among boulders, and especially beneath flat stones and concrete, gaining access via a crack. The South Island form is abundant on dry shingle and boulder banks in the beds of braided rivers on the Canterbury Plains.

Remarks. In the South Island, the North Island south of Auckland, and Northland north of Warkworth, distinctive races are easily recognisable in 100% of the population, in both sexes. Although these geographically separated forms have the characteristics of subspecies, I have decided against their formal recognition.

Sphictostethus calvus new species

ADULT

Diagnosis. Female. Colour variable. Body mostly reddish-brown, variously patterned with reddish-brown and black, or entirely black. Wings tinted

with amber; forewing with a transverse fascia. Propodeum never appearing brassy or golden. Hind tibia with a dorsal row of minute, thorn-like setae, its 7 vestigial teeth only slightly larger than those of *fugax* (Figure 36). Malar space moderately long, 0.29–0.38× as long as antennal segment 2 (see Key-figure 13a). Prementum with a fascicule of long, stiff, apically curved bristles (Figure 16). Pygidium without a sharp, median, longitudinal carina. Forewing fascia usually broad and dark, its apical margin clearly not following basal boundaries of cells *3R1*, *IRs*, *2M*, and *Cula*, and consequently fascia not appearing ‘toothed’ (cf. *fugax*). Cells *C* and *R* of forewing usually with orange setae, even on melanic Stewart Island specimens (cf. *fugax*, in which dark setae normally extend the entire length of cells *C* and *R*, and beyond margins of membrane infuscation of fascia and apical cloud). Maxillary palp with segment 4 very straight (cf. notably bowed in *fugax*).

Male. Colour variable. Body mostly reddish-brown, variously patterned with reddish-brown and black, or black. Wings amber-tinted; forewing always with a fascia, this sometimes merging completely with apical infuscation. Propodeum never appearing brassy or golden. Clypeus with a large, pale, lemon-yellow spot on either side (see Key-figure 16). Metasoma with 6th sternum bearing a large, deltoid projection on either side, near lateral margin (see Key-figure 15). Paramere with a pronounced, quadrate, lateral extension 0.43 from base (usually visible in dead specimens, even with genitalia retracted). Digitus volsellaris complex, bilobed, having a thin, translucent, laminate extension arising from its inner margin, strengthened apically, and produced into a point (Figure 65).

Description. Female. Length 9.0–14.5 mm; forewing 8.2–13.0 mm.

COLOUR AND VESTITURE. Head with apical parts of clypeus, malar area, and base of mandible either brownish-red or black. Antenna: flagellum except 1st segment dark brownish-black; scape and 1st segment of flagellum reddish-brown, sometimes infuscated, sometimes black. Palpi variously straw-coloured, dark brown, or almost black. Mesosoma and metasoma reddish-brown, black, or with areas of both colours. Legs entirely reddish-brown, or coxae, trochanters, and femora either with areas of black, especially at base, or sometimes entirely black; tarsal segments sometimes infuscated, especially the last 3 segments. Forewing subhyaline, tinted with amber. Fascia usually broad, very dark and sharply defined, not markedly toothed at level of stigma, combining posteriorly with relatively dark apical infuscation to form a characteristic dark, ‘U’-shaped area that sweeps around edge of wing

from tip of anal margin, along apical margin, to marginal cell. Stigma dark brown, opaque. All veins translucent, yellowish-brown in infuscated portions. Hind wing subhyaline, with apical infuscation and sometimes with infuscation between base of vein *Rs* and apex; remainder of wing (including extreme apex) amber-tinted. Pubescence brassy or golden, very sparse on propodeum which consequently always appears black, reddish-brown and black, or reddish-brown.

STRUCTURE. Head with submentum and fascicle of bristles very similar to those of *fugax*, but bearing only 4 pairs of very long, stout, apically curved bristles. Maxillary palp shorter than in *fugax*, the segments relatively straight; segment 3 short, thick, clavate (cf. long and slightly bowed in *nitidus*, very curved in *fugax*); segment 4 very straight (cf. slightly bowed in *nitidus*, very long and notably curved in *fugax*). Labrum specialised, its apex sharply recurved to form a wide, flat face at approximately 90° to disc. Clypeus somewhat specialised, about 2.7× as wide as high, convex, its apex swollen, flattened and arc-shaped below, the flattened area inclined towards mentum. Frons gently swollen. Malar space relatively long, about 0.29–0.38× as long as antennal segment 2. Antenna long and thin (but shorter than that of *fugax*), much shorter than distance on forewing from base to distal end of marginal cell. Front angle of ocellar triangle approximately 90°; POL:OOL about 1:2. Thorax covered with small, indistinct punctures. Propodeum evenly sloping, globose, minutely and densely rugulose-punctate, without a distinct median impression. Femora without apical spines. Apex of fore tibia with a series of small spines; apical spines larger on middle tibia; hind tibia dorsally with a vestigial tooth row, its setae reduced to minute thorns but arising from prominent protuberances (7 minute, transverse ridges correspond in position and arrangement to those of *fugax* and to the teeth of *nitidus*). Fifth tarsal segment without ventral spines. Forewing submarginal cell removed from wing-tip by about 0.45× its own length. Metasoma with 1st segment broadly rounded, not noticeably petiolate, subbasally convex in lateral view. Pygidium without a prominent, sharp, dorsal longitudinal keel.

Measurements: see Appendix 1, Table 3.

Male. Length 7.0–8.5 mm; forewing 7.2–8.3 mm.

COLOUR AND VESTITURE. Body similar to that of female. Forewing hyaline, tinted with yellow below level of stigma, with a dark fascia merging at least posteriorly with apical infuscation, as in female, but sometimes merging throughout its length. Stigma dark brown, opaque. Veins pale brown, semi-translucent. Apical 0.16 of hind wing usually clear; fascia extending to level of base of vein *Rs*. Pubescence

brassy or brassy-golden; frons with short, brassy setae; mesosoma with decumbent, brassy hairs, these becoming sparse dorsally, particularly on propodeum, which never appears golden.

STRUCTURE. Head with clypeus about 2.95× as wide as high, convex, its apical margin concave. Malar space relatively long, about 0.34× as long as antennal segment 2. Frons moderately shining, closely covered with distinct, small punctures, sometimes with a shallow median sulcus of variable extent between anterior ocellus and antennal sclerites. Front angle of ocellar triangle close to 90°; POL:OOL about 3:5. Pronotum with posterior margin angulate. Entire thorax with small, close, indistinct punctures. Propodeum sloping evenly, almost globose, its entire surface minutely rugulose-punctate, sometimes with a shallow, incomplete median sulcus. Fore femur with apical row of spines compact above, widely spaced on sides. Tarsal claws dentate. Forewing submarginal cell removed from wing-tip by about 0.36× its own length. Metasoma: 1st segment less petiolate than in *fugax* or *nitidus* (Figure 45), its tergum subangularly arcuate in lateral view; 6th sternite with a very distinct, deltoid projection near lateral margin (see Key-figure 15). Subgenital plate (Figure 56) with an apically rounded, spatulate, triangular section arising from a broad base. Genitalia with parapenial lobes apically decurved, similar to those of *fugax* (Figure 65, cf. 66). Digitus volsellaris complex, bilobed, bent inwards at 90° as in *fugax* and *nitidus*, with a thin, translucent, laminate extension rising from inner margin, and apically strengthened and produced into a point. (A finger-like extension of the lumen of the digitus enter this region.) Paramere very slender, twisted as in *nitidus*, but with a pronounced, quadrate, lateral projection 0.43 from base, and with 2 basal hooklets. Apex of aedeagus attaining approximately the same level as parapenial lobes and digitus volsellaris. General design of genitalia similar to *fugax*.

Measurements: see Appendix 1, Table 3.

Variation (Text-figure 13). **COLOUR - BODY AND LEGS.** Either sex may be mostly reddish, almost completely black, or variously patterned with black and reddish. In general, North Island individuals are castaneous-red and specimens from south of Dunedin (45°53'S) are mostly black. Melanism correlates positively with both latitude and altitude. Thus, males from over about 1065 m on Mt Egmont (39°18'S) are often mostly black, as are Stewart Island specimens. Nevertheless, both sexes exhibit gradual and parallel, fairly regular increases in melanism southwards from North Cape (34°25'S) to southern Stewart Island (47°20'S). Melanism on the body proceeds from the head to the anterior

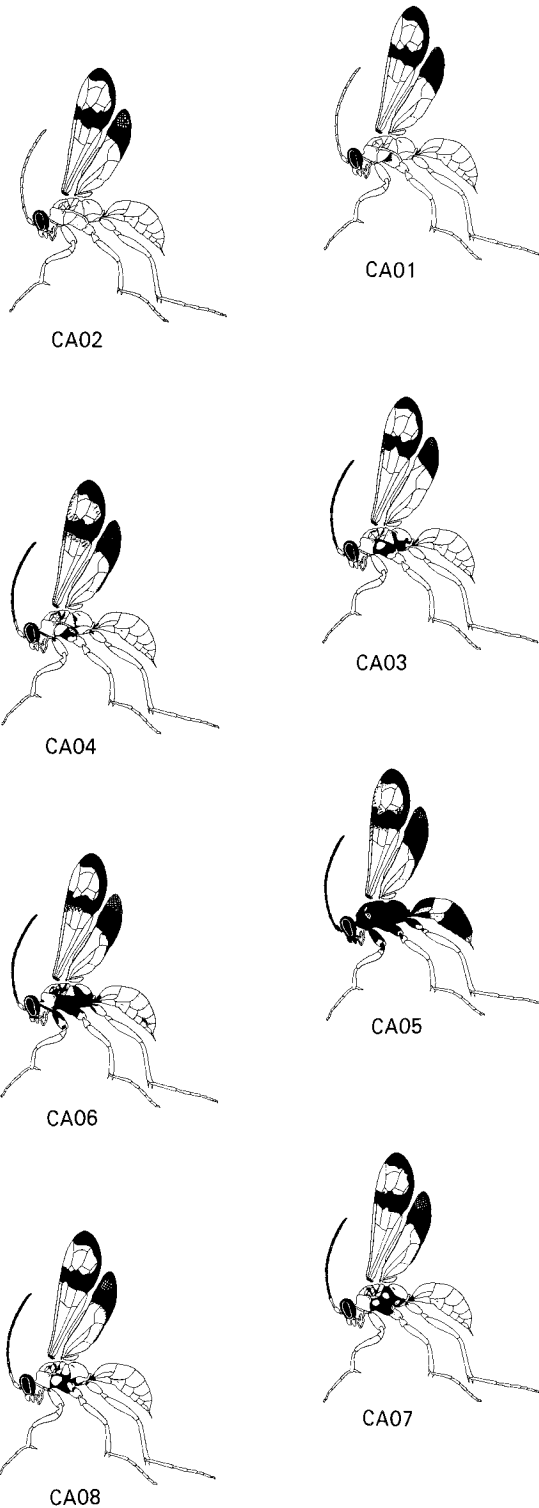

thorax, then to the propodeum, and lastly to the metasoma; on the legs it proceeds from base to apex, except on the tarsi. Harris (1974) showed experimentally that the amount of black pigment in adults is directly related to the temperature regime experienced by the early pupa when pigment deposition in the cuticle begins.

Females. North of Timaru ($44^{\circ}24'S$) the metasoma is ordinarily reddish and the mesosoma is reddish, or reddish with varying degrees of infuscation, often in a variegated pattern, or almost entirely black. Considerable variation occurs, even in small populations. For example, of six specimens captured in a 3×6 -m forest clearing in the southern Tararua Range near Renata Hut ($40^{\circ}56'S$), two had large, red spots on either side of the oblique mesepisternal suture, one had the lower spot considerably reduced, another had only the upper spot, and two had the mesepisternum uniformly dark. Specimens from Peel Forest ($43^{\circ}55'S$) have the metasoma reddish, but the propodeum shows all degrees of infuscation from completely red to entirely black. South of Timaru, the metasoma usually has varying amounts of infuscation. Specimens from Trotter's Gorge ($45^{\circ}24'S$) and Leith Saddle, Dunedin ($45^{\circ}49'S$) are very variable: the metasoma may be mostly red, or mostly black, or intermediate. All southern West Coast specimens from Lake Moeraki, Haast, and Jackson Bay ($43^{\circ}57'S$) have the head and metasoma reddish, except for the base of the first segment, which is black. Between Milton ($46^{\circ}07'S$) and southern Stewart Island ($47^{\circ}16'S$) the head, mesosoma, and metasoma are usually black, except for the second tergum of the metasoma, which is characteristically red. Nevertheless, throughout the area considerable amounts of red are often present on the metasoma. The legs of southern specimens are bright castaneous, with the bases of the coxae and the apices of the tarsi infuscated.

Males. The coloration of the head and antennae is virtually constant throughout the entire range, although the clypeus may be brownish-fuscous in non-melanics. The large, pale lemon-yellow spot on either side of the clypeus is present in both reddish and melanics forms, and in forms in which the fascia on the forewing fuses almost completely — and sometimes completely — with the apical infuscation (see 'Clypeal spots', below). North of latitude $43^{\circ}32'S$ the metasoma is usually reddish, with an infuscate band on the lower part of its fifth tergum. Even in the north the colour is very variable, there being varying amounts of black and red, often in

Text-fig. 13 (part) Selected, locally representative females of *Sphictostethus calvus*; see map on p. 81.

variegated patterns. In some specimens from Rotorua (38°03'S) the propodeum and the thorax excepting the pronotum are black, although the metasoma is mostly red. Six specimens from about 1065 m on Mt Egmont are melanic, although one has a small, castaneous area on the second metasomal tergum. Northland specimens are almost entirely reddish, with the exception of the head, which is black, and the occasional black spot near the sides of the scutum, scutellum, notum, and postnotum. Melanic forms occur commonly below latitude 44°24'S. A typical Leith Saddle melanic has the head, mesosoma, coxae, trochanters, and femora shining black, antennae and palpi black, hind tibiae fuscous, and hind tarsi fuscous grading to pitchy black apically. (Notwithstanding this, it retains the large, yellow spots on the clypeus.) In the Dunedin area the colour of the metasoma is variable. Most males from localities south of Milton have the body fully melanic. However, there is considerable variation in the degree of infuscation of the legs.

FOREWING FASCIA. Females. The fascia appears to be always present in females, and shows only minor variation. In some Nelson specimens, and most from Christchurch and central Northland, it is very narrow.

Males. Some individuals lack a distinct fascia; instead, a single large cloud extends from halfway along the first medial cell (well basad of the pre-axillary excision) to the wing apex. Other specimens are similar save for a small, paler area near the centre of the cloud.

CLYPEAL SPOTS. There is some evidence that the highly distinctive pale yellow clypeal spots of males function as a pre-reproductive isolating mechanism, effective when males approach females prior to courtship. They are constant in the 363 specimens examined from Okaihau (35°19') to Stewart Island and both on specimens in which the clypeus is castaneous and on those in which it is black. However, in 12 out of 52 Peel Forest specimens the spots are larger than usual, and converge mesally. In the areas of Peel Forest in which *calvus* occurs, *fugax* is the most abundant species of Pompilidae. (This unusual condition possibly results from the exceptionally large number of *Psepholax barbifrons* pupal chambers in trees for *fugax* to use as nests — a result of snow damage to trees following the unusually heavy snowfalls that occur there on average once every 20 years; Dr B. P. J. Molloy, pers. comm.) In this area, *fugax* males show varying degrees of infuscation on the clypeus, and some

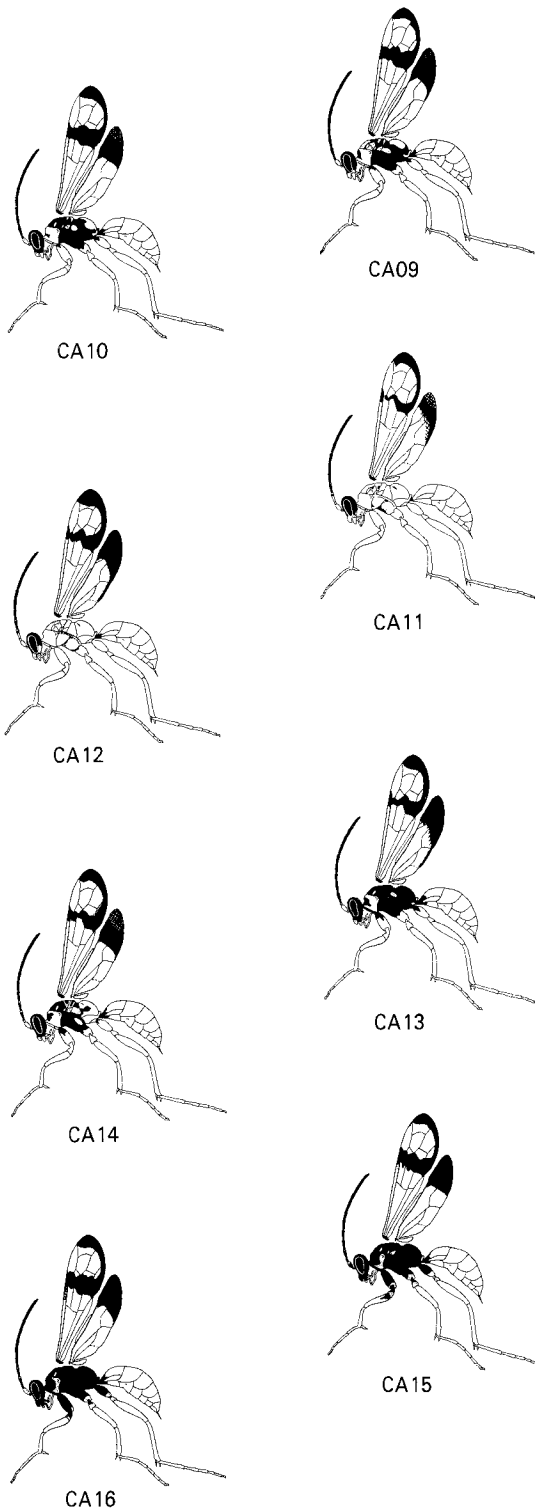

Text-fig. 13 (part) Selected, locally representative females of *Sphictostethus calvus*; see map on p. 81.

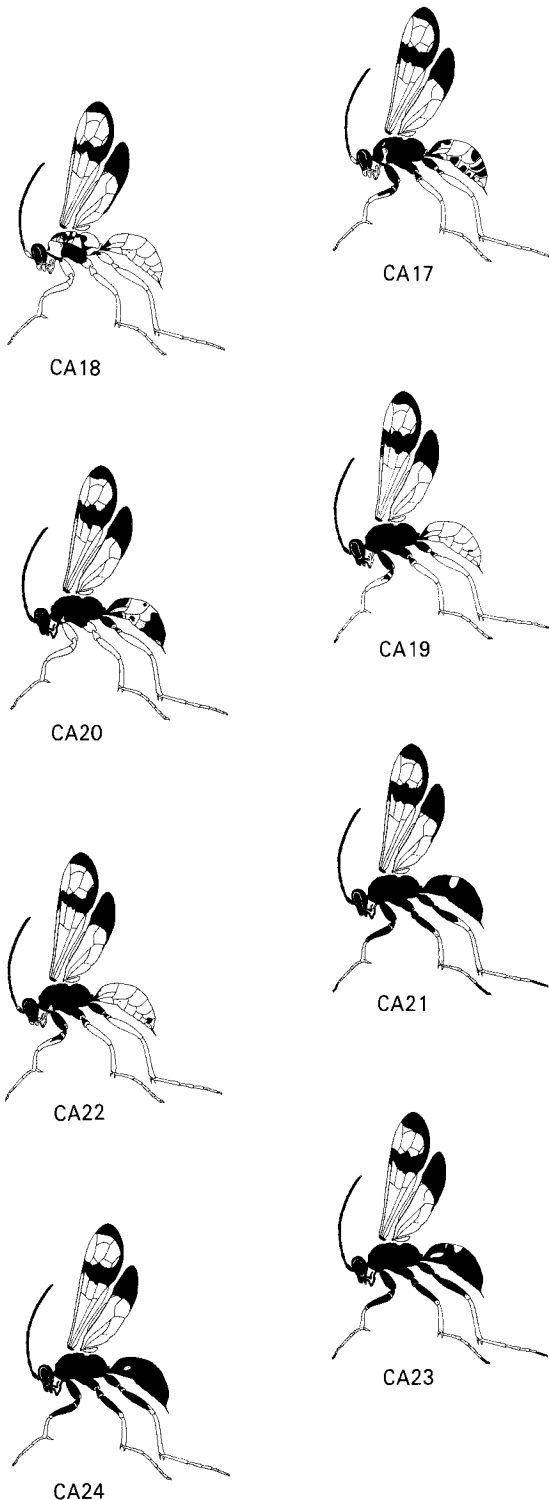

specimens have the clypeus dark except for highly variable castaneous spots. *S. fugax* shows a southward clinal increase in melanism, and it is at around the latitude of Peel Forest that the clypeus, fulvous-red in northern areas, changes to black. It is possible that the larger area of pale yellow in some *calvus* males heightens the distinctiveness of the clypeal spot, of selective advantage if, in the initial stages of courtship, *calvus* females might waste time with *fugax* males with castaneous clypeal marking.

STRUCTURE. External morphology is relatively constant in both sexes.

Males. Specimens from Okaihau frequently have the upper half of the median frontal line impressed and the lower half raised. Genitalia from localities between Northland and Stewart Island are almost indistinguishable. The subgenital plate, however, is subject to minor variation. Specimens from Nelson (41°15' S) to Dunedin (45°53' S) show a fairly regular increase in the length of the apical, digital process of the plate relative to the basal part. Between Peel Forest and Dunedin the apex is truncated and notched in the middle.

FINAL-INSTAR LARVA

Diagnosis. Head with setae on vertex and temples sparse, short (LS/OD 0.36). Labrum having on each lateral lobe 8 pigmented sensory cones and 8 setae, the latter in 2 rows. Spiracles with teeth visible at $\times 200$ on all internal ridges of atrium; subatrium cone-shaped, dilated gradually and evenly. Larvae taken from cells in rotting wood, above ground level, often under moss-covered bark on upright, decaying tree-trunks. Cells never sealed with mud.

Description (based on 2 specimens from Tautuku, SL; see 'Type data', below). Length 13.0 mm; maximum width 3.5 mm.

Body fusiform, more swollen behind middle. Supra-anal lobe much larger and more prominent than suranal lobe; anus situated lower than midway on anal segment. Pleural lobes large but ill defined. Prothorax covered with spicules and small spines of different shapes and sizes, averaging about 10 μm in length (Figure 86); spicules very densely grouped in some areas, but much more sparsely scattered on dorsum. Spicules present also on abdomen, those on venter of posterior segments longer than anterior ones.

Spiracles circular, intermediate in general organisation and appearance between those of *nitidus* and *fugax*. First thoracic spiracle (Figure 98) 65 μm in diameter; internal ridges of atrium (Figure 105)

Text-fig. 13 (part) Selected, locally representative females of *Sphictostethus calvus*; see map on p. 81.

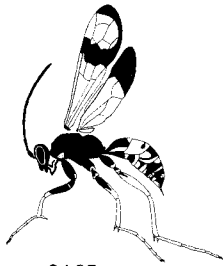

CA25

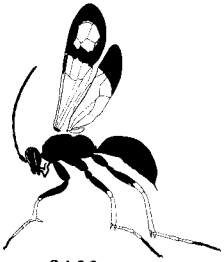

CA26

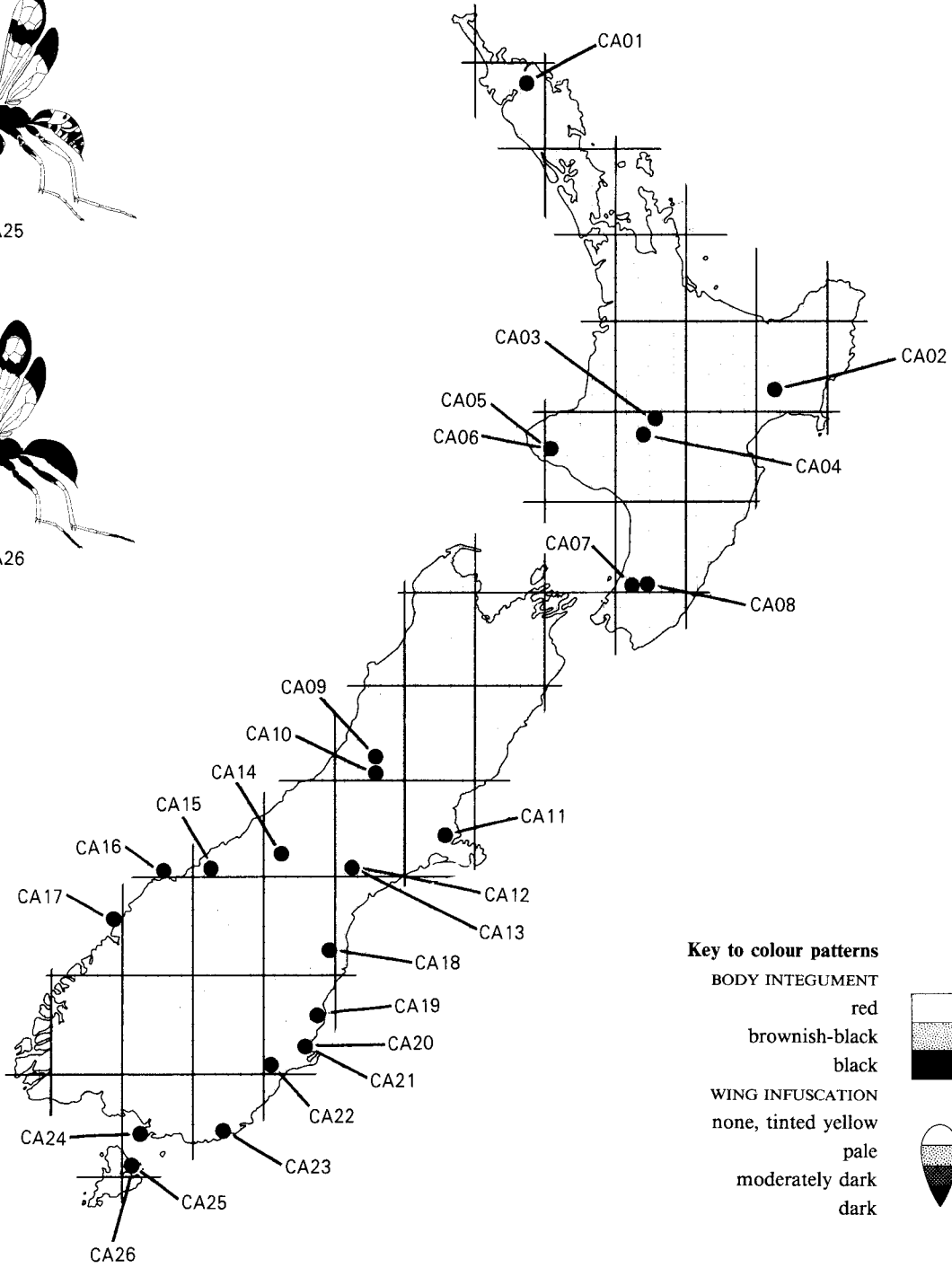

Text-fig. 13 (part) Selected, locally representative females of *Sphictostethus calvus* and their place of origin.

bearing spines, as in *nitidus*. Collar spines large, mallet-shaped. Subatrium in the shape of a laterally compressed cone, widening gradually from atrium, its walls thrown into 5–7 rows of very irregular folds. Proximal to this folded area is a dilated, smooth-walled region, circular in outline and with little taenidial strengthening, which narrows gradually to diameter of trachea. Subatrium lined internally with large, toothed, mallet-shaped spines.

Head as in Figure 120; height (excluding labrum) 1.25 mm; width 1.55 mm. Parietal bands long, moderately pigmented, similar to those of *nitidus* and *fugax*. Head setae sparse, proportionately longer than in *nitidus* and *fugax*, but much shorter than those of any other New Zealand species outside genus *Sphictostethus*. Largest head seta (on gena) 38 μm long; LS/OD 0.36. Four shallow impressions in a row between parietal bands above level of antennal orbits. Antennal papilla (Figure 128) large, 35 μm long (excluding apical sensillae, which are each 11 μm long); antennal orbits 105 μm in diameter. Clypeus (see Figure 120) with 6 setae in a group of 3 on either side, without a median impression. Labrum (Figure 138a,b) 165

Text-fig. 14 Distribution of collection localities, *Sphictostethus calvus*.

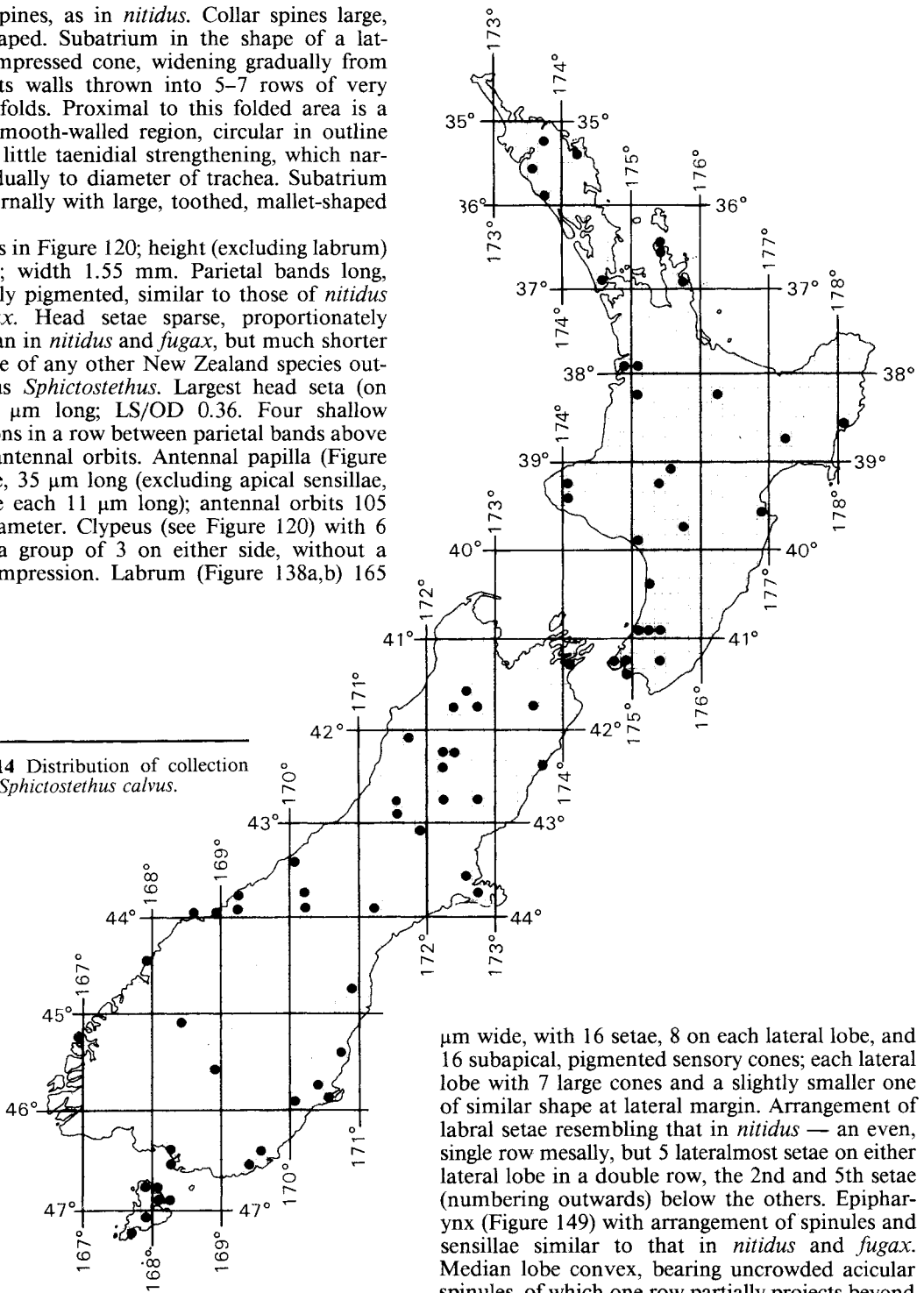

μm wide, with 16 setae, 8 on each lateral lobe, and 16 subapical, pigmented sensory cones; each lateral lobe with 7 large cones and a slightly smaller one of similar shape at lateral margin. Arrangement of labral setae resembling that in *nitidus* — an even, single row mesally, but 5 lateralmost setae on either lateral lobe in a double row, the 2nd and 5th setae (numbering outwards) below the others. Epipharynx (Figure 149) with arrangement of spinules and sensillae similar to that in *nitidus* and *fugax*. Median lobe convex, bearing uncrowded acicular spinules, of which one row partially projects beyond apical margin, i.e., visible beyond median labral

lobe; apical margin gently rounded. Mandibles 0.51 mm long, with 2 setae 30 μm long, one basad of the other by 12 μm . Labium and maxillae (Figure 167): galeae and maxillary palpi subequal in size and shape; labial palpi 55 μm long; galeae 75 μm long by 42.5 μm wide at base; maxillary palp 81.6 μm long by 55 μm wide at base. Spinneret 157 μm wide; 1 or 2 spinneret setae present, as in *nitidus* and *fugax*.

Type data. **Holotype** female and **allotype**: New Zealand, SC, Waimate, Kelsey's Bush (eastern side), 9 January 1974, A. C. Harris (NZAC). **Paratypes**: all specimens collected by A. C. Harris are here designated as paratypes, viz 534 females and 334 males from the following localities. ND – Mt Unuwhao; Manginangina Kauri Reserve. BP – Rotorua. GB – Aniwanuiwa. TO – Pokaka; northern Kaimanawa Range. TK – Dawson Falls. WN – Renata Hut, Tararua Range; Akatarawa Saddle; Wainui Ridge. NN – Puhipuhi Reserve, Nelson. MB – St Arnaud Range. BR – L. Daniells. NC-WD – Arthur's Pass; Aikens, Otira. WD – Pleasant Flat, Haast R.; Haast R. mouth; L. Moeraki; Port Jackson; Martin's Bay. MC – Riccarton Bush, Christchurch; Peel Forest, Waiho. SC – Peel Forest; Kelsey's Bush, Waimate. DN – Trotter's Gorge; Moeraki; Leith Saddle, Dunedin; Woodside Glen. SL – Tahokopa; Tautuku; Green Hill, Tara Downs. SI – Oban; Thule; Horseshoe Bay; Garden Mound; Lee Bay; Little River; Maori Beach; Christmas Village; Port Pegasus.

Material examined. Type series, plus 61 non-type adults (32 females, 29 males) from Mt Unuwhao (latitude 34°26'S) to southern Stewart Island (47°15'S). Also 2 final-instar larvae from Tautuku (SL), 12 Mar 1972, 2 m from ground in a rotten, moss-covered, standing rimu trunk in dense forest (dissected). Collection localities: see Text-figure 14.

Taken from sea level to at least 1300 m.

Adult females were collected from October to April, and were most abundant in January and February. Adult males were collected from October to February, and were most abundant from December to February.

Biology. **HUNTING.** *S. calvus* hunts in forest, on rotting timber and the bases of trees, especially decaying, standing trunks festooned with webs of *Ixeuticus*, *Neoramia* (Dictynidae), and others. Hunting females frequently walk over webs, search through them, and sometimes drive spiders out of retreats. The spider is stung in the prosomal venter. After paralysis sets in, the wasp examines the spider's chelicerae and then stings it again in the prosomal venter. The spider is then either left

exposed, venter uppermost (usually), or is dragged away and hidden while the wasp makes a cell.

PARALYSIS is deep and permanent.

PREY CARRIAGE. Generally, large spiders are grasped by the base of a third leg coxa and dragged backwards, venter uppermost. Sometimes spiders are dragged many metres by the spinnerets. (Other New Zealand Pepsinae usually drag spiders by the spinnerets only during final placement, when the prey is left a few centimetres from the nest entrance.) Although all New Zealand Pepsinae run forwards when transporting very small spiders, *calvus* does so with proportionately larger spiders than are carried by any species other than those in the *nitidiventris* species-group. Notwithstanding this, *calvus* drags spiders about as large as itself backwards (unlike *nitidiventris* species-group members, which push such spiders forwards, except when temporarily obstructed). Prey spiders are not taken to a place of temporary concealment.

NIDIFICATION FORMULA. Prey – nest – egg – closure (usually); or nest – prey – egg – (cell) – closure.

NEST (Figure 197). *S. calvus* favours humid, forested areas, and constructs (usually) single-celled nests in rotten wood and, occasionally, in long-abandoned galleries of wood-boring insects. Typical sites for nests include dry, almost powdery rotten wood beneath the moss-covered bark of standing, decaying trunks in primary forest. This wasp also nests in rotting logs on the ground, sometimes in quite small sticks.

Although it often nests in long-vacated burrows of wood-boring insects in crumbling wood, *calvus* will sometimes carve out a burrow in very rotten timber. It sometimes also clears a space in frass between the bark and the powdery wood. One cylindrical cell bitten out of a very rotten log (Tautuku, SL) was 9 mm in diameter and 28 mm long. The paralysed spider was placed at the end, facing the cell entrance, its legs to the sides, not extending in front as with *S. fugax* hosts.

After oviposition, *calvus* closes the cell with a fibrous plug. Females on the surface of decaying trunks scrape off fragments of moss, bark, fibres, etc., using the mandibles and the apex of the abdomen, and place them on the underside of the head in a manner similar to *fugax* when gathering dark, fibrous material for the inner part of its cell partitions. Although larger fragments are occasionally held in the mandibles, most of the moss, frass, fibres, etc. is held in the premental bristles with the labial palpi wrapped around it.

The cell described above was blocked with a plug of 8 mm long by 9 mm in diameter, comprising powdery rotten wood, plant fibres (including tiny fern rhizomes), sections of moss, very old larval

beetle frass, and pieces of spider web, the whole bound together by its content of fibres and webbing. The plug covered the anterior third of the host's prosoma. Seals made by *calvus* often resemble the inner, matted, fibrous part of *fugax* seals, i.e., without the outer covering of moulded clay. Fifteen nests dissected were single-celled and very similar to the one described. Nine were in standing trunks, and six were in logs or sticks on the forest floor.

LIFE HISTORY. The oblong-ovate egg, 1.77 mm long, is laid anterolaterally on the left or right of the host spider's abdomen (Figure 197). At approximately 15°C eclosion occurs after about 2.5 days. The fifth instar is attained after 13–16 days, and feeds rapidly for 14–16 hours. The larva commences spinning its cocoon 14 hours after it finishes eating. Prepupal diapause lasts about 7 months.

The cocoon (Figure 211), similar to that of *S. nitidus*, is 9–19 (13) mm long, sub-pyriform, truncate at the meconial end, rigid, opaque, and varies from greyish-buff through greyish-brown to terracotta in colour.

Remarks. The name *calvus* — Latin, 'bald' — alludes to the absence of brassy pubescence on the propodeum.

***Sphictostethus fugax* (Fabricus) new combination**

fugax Fabricius, 1775, p. 350, no. 27 (*Sphex*); 1781, p. 449, no. 38; 1787, p. 276, no. 44; 1793, p. 63; 1798, p. 250, no. 24 (*Pompilus*); 1804, p. 194, no. 35 (*Pompilus*). Gmelin, 1790, p. 2731, no. 65 (*Sphex*). Christ, 1791, p. 290 (*Sphex*). White in Dieffenbach, 1843, p. 282 (*Sphex*). Smith, 1855, p. 163, no. 223 (*Pompilus*). Buller, 1877, p. 343 (*Pompilus*). Hutton, 1874, p. 165 (*Pompilus*); 1881, p. 107 (*Pompilus*); 1904, p. 98 (*Salius*). Kirby, 1881, p. 39; 1884a, p. 68 (*Priocnemis*). Hudson, 1892, p. 34, pl. 3 fig. 2 (*Pompilus*). Dalla Torre, 1897, p. 224 (*Salius*). Cameron, 1898, p. 48; 1903, p. 297 (*Salius*). Miller, 1919, p. 205 (*Pompilus*); 1955, p. 35, fig. 106; 1971, p. 26 (*Salius*); 1984, p. 26 (*Salius*). Valentine, 1967, p. 1143 (*Salius*); 1974, p. 1234 (*Cryptocheilus*).

fujax Gourlay, 1927, p. 692 [misspelling of *fugax*].
maculipennis Smith, 1876, p. 482 (*Priocnemis*). Kirby, 1881, p. 39; 1884a, p. 68 (*Priocnemis*). Waterhouse, 1883, pl. 137 fig. 9 (*Priocnemis*). Hutton, 1881, p. 108 (*Priocnemis*); 1904, p. 98.

[*huttonii* Kirby, 1881, p. 44; 1884a, p. 72 (*Ichneumon*; female only). Turner in Meade-Waldo *et al.*, 1915, p. 334. Townes *et al.*, 1961, pp. 370–372 (*Degithina*). (Female redescribed by Kirby, 1883, p. 200, as type of *Priocnemis xenos* Kirby; see Turner in Meade-Waldo *et al.* 1915.)]

huttoni Kirby, 1883, p. 199 (*Priocnemis*). Waterhouse, 1803, pl. 137 (*Priocnemis*). Dalla Torre, 1897, p.

288 (*Salius*). Cameron, 1903, p. 297 (*Salius*). Hutton, 1904, p. 98 (*Salius*). **New synonymy.**
xenos Kirby, 1883, p. 200 (*Priocnemis*). Waterhouse, 1883, pl. 137 (*Priocnemis*). Dalla Torre, 1897, p. 228 (*Salius*). Cameron, 1903, p. 297 (*Salius*). Hutton, 1904, p. 98 (*Salius*). Turner in Meade-Waldo *et al.*, 1915, p. 334 (*Priocnemis*). **New synonymy.**
brownii Gribodo, 1884, pp. 280–281, no. 19 (*Agenia*). Dalla Torre, 1897, p. 199 (*Pseudagenia*). **New synonymy.**
brouni Cameron, 1903, p. 297 (*Salius*) [emendation of *brownii*]. Hutton, 1904, p. 98 (*Salius*).

ADULT

Diagnosis. FEMALE. Colour variable; body variously patterned with reddish-brown and black; wings amber-tinted; forewing usually with transverse fascia of variable expression, occasionally completely absent. Propodeum with dense, glistening, brassy or golden pubescence; face with glistening golden pubescence. Prementum with a fascicle of very long, apically curved bristles (Figure 17). Antennae and labial and maxillary palpi unusually long and slender. Malar space very short, 0.03–0.21× as long as antennal segment 2 (see Key-figure 13b). Metasoma with 1st segment distinctly petiolate, its tergum gently and evenly rounded, without a declivity, in lateral view (Figure 41); last segment dorsally with a sharp, median longitudinal carina (see Key-figure 12).

MALE. Colour variable; body variously patterned with reddish-brown and black; forewing with a transverse fascia of variable expression, sometimes very reduced. Propodeum with dense, glistening, brassy or golden pubescence. Metasoma with 1st segment defined, subpetiolate (Figure 47); 6th sternum bearing medially a single prominent, deltoid keel (see Key-figure 14). Paramere very broad, expanded outwards, with peg setae on its outer margin (Figure 66).

Description. Female. Length 8.0–15.0 mm; forewing 7.5–14.0 mm.

COLOUR AND VESTITURE. Head: vertex and frons black; clypeus and reddish-brown or black; mandibles with bases reddish-brown or black, apices black. Antennae: scape and 1st segment of flagellum reddish-brown or black, remainder of flagellum brownish-black or black. Labial and maxillary palpi entirely straw-coloured, infuscated, or entirely black. Mesosoma variously variegated with reddish-brown and black, or entirely black. Legs entirely reddish-brown, or with coxae, trochanters, and last 3 tarsal segments black. Metasoma entirely reddish-brown, reddish-brown and black, or entirely black. Forewing subhyaline; proximal 0.7 tinged with yellow; apex lightly infuscated; a fascia usually present, at level of stigma, its apical border crossing cells *3R1*, *1Rs*, *2M*, and *Cula* and following their basal boundaries, thereby appearing jag-

ged, with a central tooth directed towards apex (cf. fascia of *calvus*, in which this does not occur). Veins usually amber, translucent, but in some melanics entirely infuscated. Stigma dark fuscous, opaque. Hind wing hyaline; proximal 0.4 tinted anteriorly with yellow, remainder lightly infuscated. Frons, clypeus, pronotum, mesepisternum below oblique suture, and propodeum densely clothed with brassy or golden pubescence, appearing bright golden or brassy in dorsal view. Pubescence on vertex of head, mesepisternum above oblique suture, metapleuron, mesoscutum, mesoscutellum, and metapostnotum appearing notably less brassy or golden in dorsal view. Clypeus, genae, and mandibles with long, erect hairs. Remainder of body sparsely hairy, except apex of metasoma, which has somewhat reduced pygidial bristles.

STRUCTURE. Head with submentum having 16 very long, stiff setae divided basally into left and right groups, forming a 'mud basket' (Figure 17). Maxilla and labium resembling those of *nitidus*, but with both pairs of palpi and mental bristles very elongate. Maxillary palp segments 2-5 very long and very curved, differing thus from *nitidus* and *calvus*; segment 3 long, much thicker than in *calvus* or *nitidus*, and notably bowed; segment 4 exceptionally long, thin, and very bowed (modifications for carrying). Labrum specialised, its apex sharply recurved to form a very wide, flat face at about 90° to disc. Mandibles unidentate, their inner surfaces smoothly and evenly excavated. Malar space very short, about 0.03-0.21× as long as antennal segment 2. Clypeus somewhat specialised, about 2.81× as wide as high, convex, vaulted forwards; apical rim very swollen, forming a flattened surface below, curved in an arc and inclined towards mentum. Antennae very long and slender, about as long as forewing from base to apical end of marginal cell. Frons shining, with small, shallow punctures; median frontal line variable, shallow, often extending from midway between antennal sockets to anterior ocellus, impressed on its distal 0.7, obsolete above; POL:OOL about 2:1 to about 11:7. Mesoscutum moderately shining; prescotal sulcus distinct; median scutal line absent. Propodeum evenly sloping, often with a very indistinct median impression. Lateral swellings obtuse, with a pair of short, longitudinal impressed lines (visible on removal of pubescence - Figures 41 and 46). Femora without apical spines. Tibiae with an apical series of small spines; fore tibia with outer apical bristle vestigial; hind tibia very smooth, with only a few minute, scattered spines, lacking a distinct dorsal row of teeth, these represented basally by 7 vestigial, oblique, deeply pigmented swellings (Figure 37). Fifth tarsal segment ventrally without pre-apical spines; claws dentate. Forewing mar-

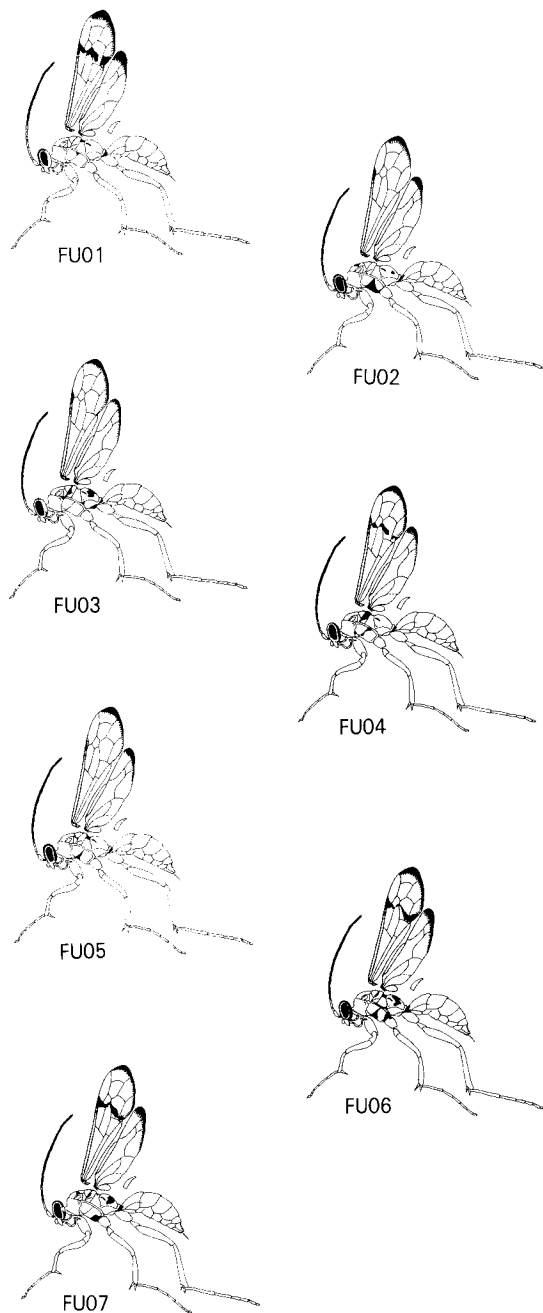

Text-fig. 15 (part) Selected, locally representative females of *Sphictostethus fugax*; see map on p. 89.

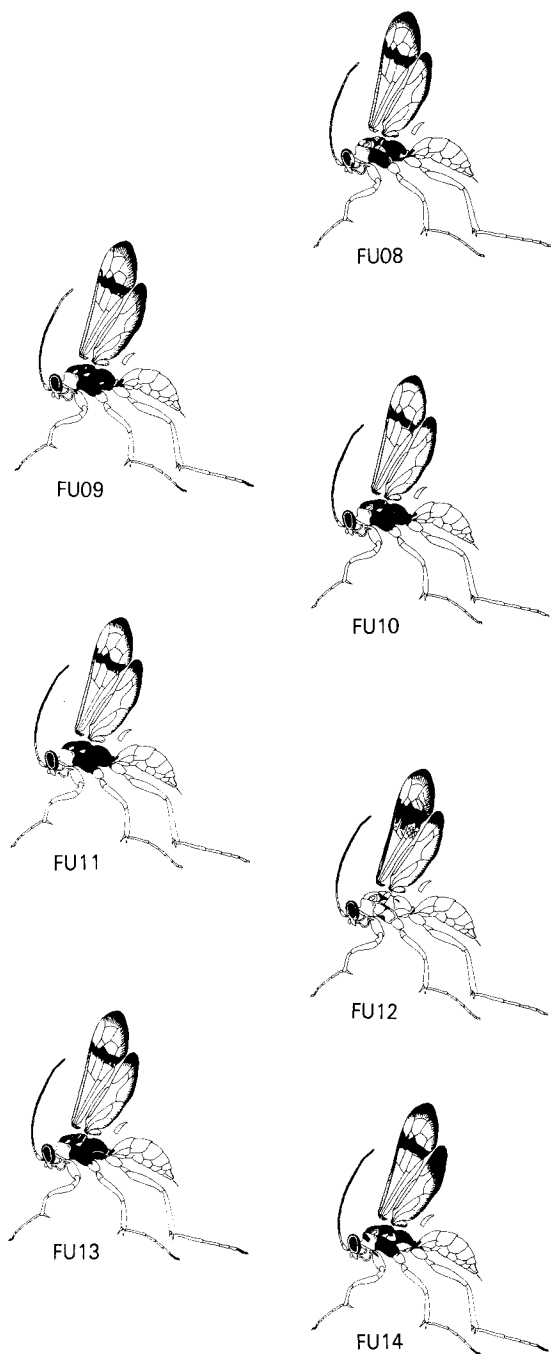

Text-fig. 15 (part) Selected, locally representative females of *Sphictostethus fugax*; see map on p. 89.

ginal cell removed from wing-tip by about $0.40\times$ its own length (Figure 30). First segment of metasoma very well defined, subpetiolate, its sides in dorsal view sub-basally concave, in lateral view with tergum gently and evenly rounded, without a declivity. Last apparent tergum (pygidium) with a sharp, median, longitudinal carina.

Measurements: see Appendix 1, Table 3.

Male. Length 6.7–9.6 mm; forewing 6.5–9.3 mm.

COLOUR AND VESTITURE. Similar to female, but darker. Head and mesosoma similar to female; metasoma with at least the final segment black. Legs with 5th tarsal segment black, otherwise varying from almost entirely reddish-brown to entirely black. Wings similar to those of female, but almost always with a fascia, which often fades towards anal margin. Frons dully shining. Clypeus, frons, pronotum, thoracic pleura, and propodeum thickly covered with brassy-golden pubescence. Clypeus, genae, and mandibles with long, erect hairs; propodeum with scattered, fine, erect hairs; metasoma with short, scattered, brassy hairs; remainder of body sparsely hairy.

STRUCTURE. Head with apex of labrum always visible, its apical margin straight. Clypeus convex, vaulted forwards, emarginate, its apex concave. Malar space short, about $0.10\text{--}0.13\times$ as long as antennal segment 2. Frons closely covered with small punctures; median frontal line between antennal sclerites and anterior ocellus variable, its apical half often moderately incised. Front angle of ocellar triangle less than 90° ; POL:OOL about 11:7. Pronotum short, its posterior margin broadly angulate; mesoscutum large; prescutal sulci present. Metanotum and metapostnotum comparatively wide, the latter with prominent, transverse rugae; remainder of thoracic dorsum with very small, close punctures, shining. Propodeum evenly sloping, usually with a median sulcus. Apices of tibiae with a series of small spines; fore tibia with outer spur vestigial; tarsal claws dentate. Forewing marginal cell removed from wing-tip by about $0.32\times$ its own length. First segment of metasoma defined, subpetiolate, its tergum gently and evenly curved in lateral view. Sixth metasomal sternum bearing medially a single prominent, sharp, deltoid keel (see Key-figure 14). Subgenital plate broadly rounded at apex, its basal portion with a complex groove for reception of 8th sternum, and a longitudinal, compressed tooth (Figure 57). Genitalia with aedeagus simple; parapenial lobes simple, apically decurved through 90° . Digitus volsellaris folded back on itself through 90° at apex, level with (and pointing towards) apex of aedeagus; apex bearing long, narrow, trichoid sensillae. Parameres very broad, with an outer median lobe bearing very stout, truncated pegs (Figure 66).

Measurements: see Appendix 1, Table 3.

Variation (Text-figure 15). **FOREWING FASCIA.** This is extremely variable in both sexes. It may be very dark, or completely absent; it may cross the wing as a very dark, broad band, a very narrow band, or a faint, broad band. Sometimes it stops just short of the pre-axillary excision. Again, it may extend only halfway across the wing, or occur as a faint smudge near the stigma. It is variable even within localised populations. Proportionately more females than males have no fascia, and this condition appears to be associated with a Müllerian mimicry ring. There are two large areas in which most females lack a fascia: a southern area of hundreds of square kilometres in mid Canterbury, bounded on the west by the Southern Alps and centred on Peel Forest (43°55'S); and a far northern area of similar extent that encompasses the Puketi Kauri Forest (35°14'S). In both areas individuals occur with a few small spots of infuscation placed anywhere along the region usually occupied by fascia. Outside these two main 'clear-winged' areas, populations show a gradual increase in the size of the fascia northwards and southwards. Thus, South Island forms with a fascia extending about halfway across the wing appear at the Hunters Hills (44°28'S), and most individuals south of the Waitaki River (44°56'S) have a distinct fascia that usually crosses the wing. At Arthur's Pass, on the western boundary of the clear-winged area, a bimodal population occurs, embodying individuals completely without a fascia, through all types of intermediates, to specimens with a very large, exceptionally dark band that completely crosses the wing. The fascia is unusually well developed throughout Westland, and it seems likely that a mixing of eastern and western populations overlap at about Arthur's Pass, where suitable habitats occur in forest on either side of the Main Divide. Thus, down the course of the Otira River, Westland population types soon predominate; and likewise Peel Forest forms in the Bealey River to the east. In the far northern area, near Leigh and Warkworth (36°24'S), the fascia is variously incomplete and represented by a series of small smudges, through a range of intermediates to one extending halfway across the wing. Wasps from Mt Unuwaho (34°26'S) are variable; although all have a recognisable fascia, it is usually narrow or incomplete.

Variation in the expression of the fascia is paralleled in *calvus*, which has the fascia particularly dark, complete, and strong in Southland, Stewart Island, and central and southern areas of the North Island, but very weak in mid Canterbury and mid Northland. In those areas *fugax* and *calvus* are associated with *nitidus*, which lacks entirely the dark

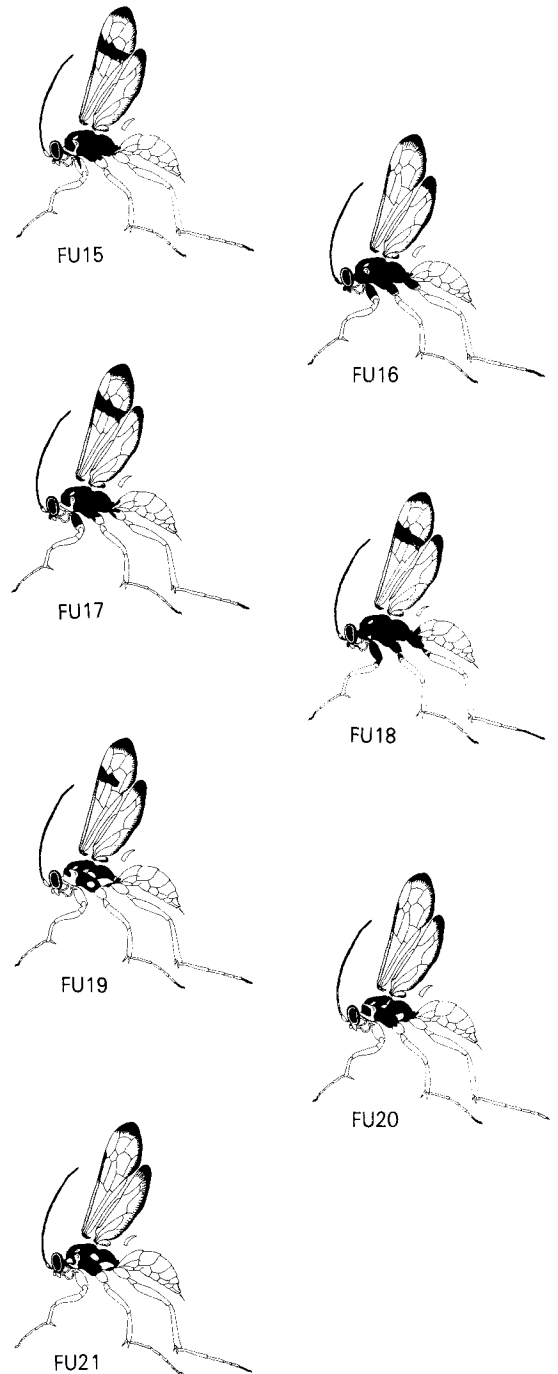

Text-fig. 15 (part) Selected, locally representative females of *Sphictostethus fugax*; see map on p. 89.

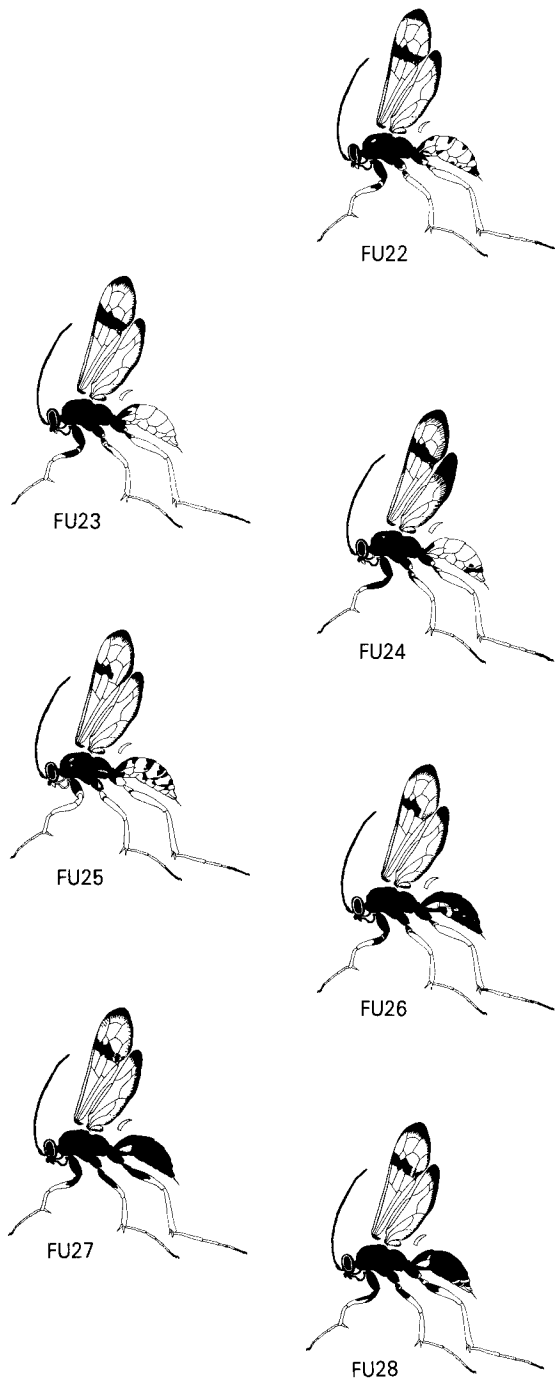

Text-fig. 15 (part) Selected, locally representative females of *Sphictostethus fugax*; see map on p. 89.

wing infuscation present on females between Wellington and Auckland. Among New Zealand wasps there are several mimics that beautifully duplicate wing patterns of other species.

COLOUR OF BODY AND LEGS. Either sex may be mostly red, mostly black, or variously patterned with red and black. Reddish wasps occur in the north, and melanics are found south of about 45°50' S. As in *calvus*, melanism is positively correlated with both latitude and altitude, and similarly is related directly to the temperature regime experienced by the early pupa when pigment deposition in the cuticle begins (Harris 1974). Considerable variation can occur over small distances. Thus, in greater Dunedin the metasoma of females is often completely shiny black on Swampy Spur at 380 m, half red and half black on the Otago Peninsula, and often completely red at Woodside Glen, Outram. Both sexes nevertheless show gradual and parallel, fairly regular increases in melanism southwards from Mt Unuwhao (34°26' S) to southern Stewart Island (47°16' S). Males are darker than females. The coloration of the male and female, as described above, is typical of forms occurring between the latitudes of Auckland and Christchurch. However, some specimens from between Nelson and Christchurch have varying amounts of reddish-brown on the metanotum, metapostnotum, and metasoma, the occasional one having these parts entirely reddish-brown. North of Auckland this last form predominates.

At Owaka, Piano Flat, Queenstown, Leith Saddle (Dunedin), and Oban (Stewart Island) typical females are black with a reddish tinge on the apical margins of most metasomal sternites, have the second tergite entirely red, and have the remaining tergites black. The palpi are infuscated. The legs are castaneous on the tibiae and black on the coxae, trochanters, fore femora, and basal third of the hind femora. A few specimens from these localities have almost no red on the metasoma. Specimens from Port Pegasus and below in the south of Stewart Island have the hind femora black and the middle femora lightly infuscated castaneous. The metasoma has tinges of reddish-brown laterally on the first and second segments.

Males with the apical four segments of the metasoma black occur as far north as Pureora (38°31' S). Fully melanic males occur at lower latitudes than do females. Thus, most Leith Saddle specimens have no red on the body (excluding its appendages). Antennae, palpi, coxae, trochanters, and — to a varying extent — the bases of the femora are black. Stewart Island specimens have all femora black, and tibiae and tarsi infuscate.

STRUCTURE. There is little structural variation in either sex. In females the maxillary palp becomes

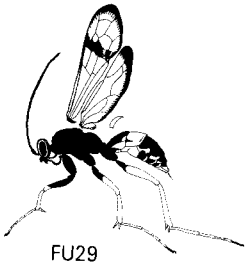

FU29

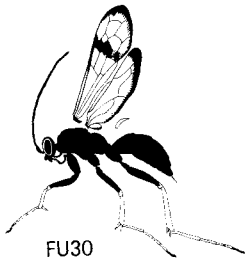

FU30

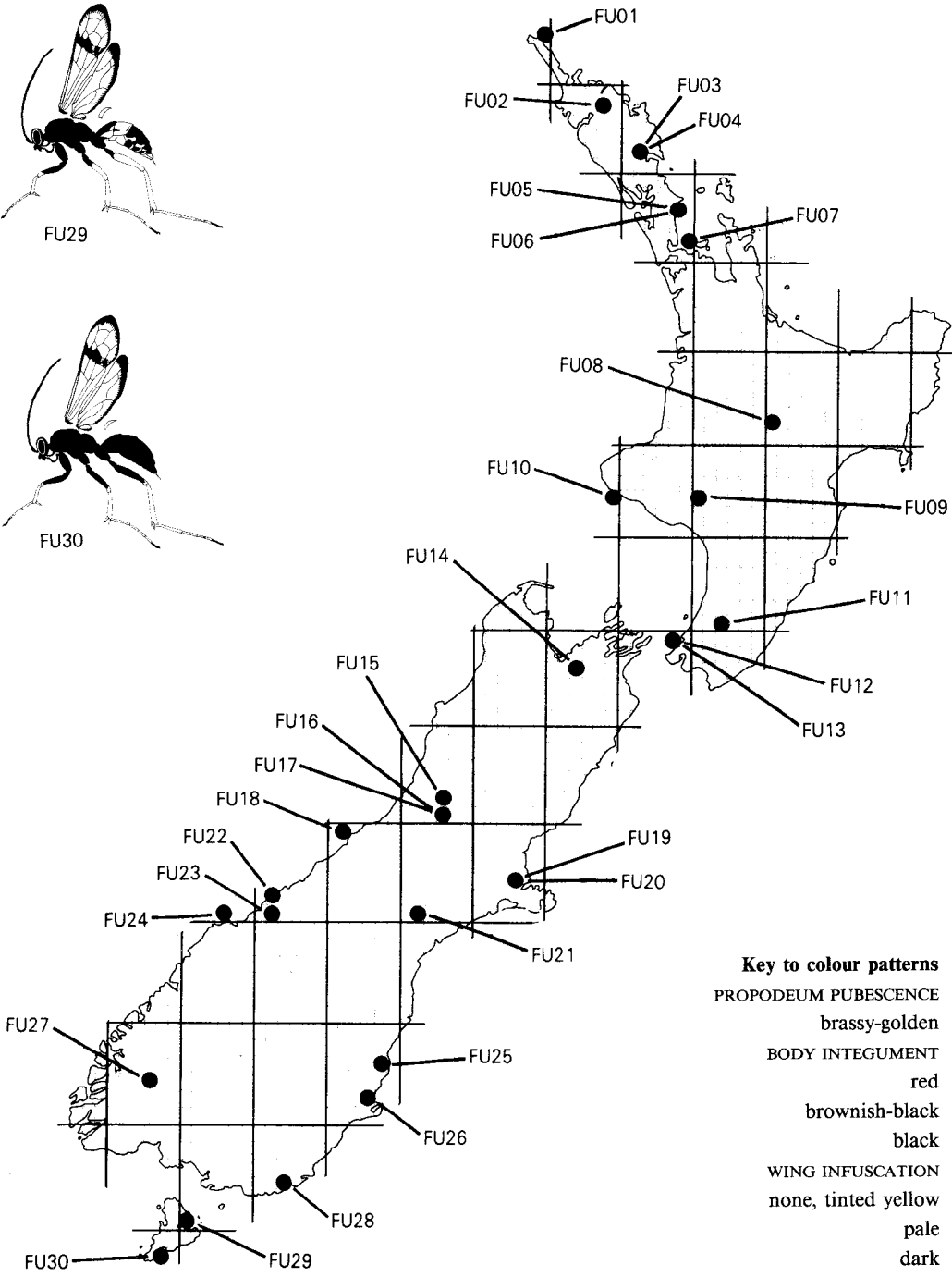

Text-fig. 15 (part) Selected, locally representative females of *Sphictostethus fugax* and their place of origin.

regularly and progressively shorter with increasing latitude. This may reflect a reduction in surface area in relation to decreasing mean annual temperature.

TERATOLOGICAL ABNORMALITY. A specimen from Trotter's Gorge (45°24'S) has the entire frons and vertex very deeply rugose. The labrum is exserted; its disc is concave and densely covered with short, peg-like setae.

FINAL-INSTAR LARVA

Diagnosis. Head with setae on vertex and temples sparse, minute; largest head seta (on clypeus) 25 μm long; LS/OD 31. Clypeus without a median impression. Labrum subangulate, with 10–12 setae and 14 large, submarginal, pigmented sensory cones; median lobe with apical margin subrectilinear. Epipharynx with well spaced, small, blunt spinules on median lobe. First thoracic spiracle: atrium without spines on internal anastomosing ridges ($\times 200$); subatrium notably narrower than atrium. Larvae occur above ground in abandoned pupal beetle chambers, usually in standing timber, and always behind a plug of mud.

Description (based on a specimen from Peel Forest, SC, 17 Jan 1973). Length 17.0 mm; maximum width 3.2 mm.

Body (Figure 74) fusiform, more swollen behind middle; pleural lobes moderately well developed; supra-anal lobe larger than suranal lobe; anus below middle of anal segment. A single, transverse row of setae present on both thoracic and abdominal segments (Figure 87). Elsewhere setae scattered very sparsely, particularly on pleural lobes. Abdominal spicules (Figure 87) about 2 μm long, thinly scattered, especially on venter and pleura.

Spiracles small, pale yellow, round. First thoracic spiracle (Figure 94a–c) 54 μm in diameter, similar in organisation and general appearance to that of *nitidus*, but ridges on inside of atrium (Figure 106) mostly lacking spines, and slightly more regular. Cells bounded by atrial ridges irregular, not elongate; some with a short, median, vertical extension. Collar bearing small, scattered spines. Subatrium notably narrower than atrium, with grouped teeth lining internal walls. Second thoracic spiracle (Figure 108) very reduced, 37 μm in diameter (0.67 \times as wide as 1st thoracic spiracle); atrium connected to trachea by a 132- μm -long section of uniformly narrow tissue not strengthened or lined with taenidia.

Head (Figure 121): height (excluding clypeus) 1.27 mm; maximum width 1.47 mm; HW/HH 1.16. Parietal bands similar to those of *nitidus*, long (approximately 0.27 mm), extending beyond lower levels of antennal orbits. Head setae sparse, very

short, the longest (on clypeus) 25 μm long; LS/OD 31. Greatest diameter of antennal orbits 80 μm ; antennal papilla long (43 μm), 0.54 \times diameter of antennal orbits. Frons with 4 shallow depressions between parietal bands, just above level of antennal orbits. Clypeus with 6 setae, without a median impression. Labrum (Figure 139a,b) similar in overall shape to that of *S. nitidus*, with 10 transverse setae and 14 submarginal, pigmented sensory cones; median height 0.17 mm, width 0.41 mm; lateral lobes well separated medially by a sulcus, each subrectilinear in outline, its apex gently convex, its anteroapical angle sharply rounded through 90°; median lobe moderately well developed, its apex very gently and unevenly convex, though appearing unusually straight-edged. Epipharynx (Figure 150) generally similar to that of *nitidus*, with 6 or 7 acicular spinules on outer lateral margins, and with broad scales bearing 5 or 6 apical points on most of disc, except median area, which has small, simple, uncrowded, blunt spinules. Thirteen conspicuous sensillae present on lateral lobes close to epipharyngeal centre, the apicalmost pair on round basal plates. Mandibles (Figure 157) 0.48 mm long, 0.31 mm in maximum width, 1.55 \times as long as wide, with 1 lateral seta. Labium and maxillae (Figure 168): galeae and maxillary palpi subequal in size and shape, the galeae very much narrower and attenuated at distal 0.7, 88 μm long, 52 μm wide at base. Maxillary palpi in the form of even, truncated cones, 88 μm long, 59 μm wide at base. Lacinal area spinulose, notably produced. Labial palpi 34 μm long, 29 μm wide at base; a characteristic row of 3 setae extending on either side, behind palpi, to sides of spinneret. Spinneret very concave medially, 0.42 μm wide, with 1 or 2 spinneret setae.

Variation. The number of setae on the labrum varied, 6 specimens having 10, 2 having 11, and 5 having 12 setae. The number of large, submarginal, pigmented sensory cones also varied, 6 specimens having 12, 5 having 14, and 2 having 13 cones.

Type data. **Holotype** female of *fugax* Fabricius: New Zealand, J. Banks and D. C. Solander (BMNH). **Holotype** female of *maculipennis* Smith: Peel Forest (SC), C.M. Wakefield (BMNH). **Holotype** male and **allotype** of *huttonii* Kirby, 1881: Dunedin (DN), Hutton (BMNH). **Holotype** female and **allotype** of *huttoni* Kirby, 1883: New Zealand, F. W. Hutton (BMNH, Banks Collection). **Holotype** male and **allotype** of *xenos* Kirby: New Zealand, F. W. Hutton (BMNH). **Holotype** female of *brownii* Gribodo: Howick (AK), T. Broun ("C. Brown") (Museo Civico di Storia Naturale 'G. Doria', Genoa).

The holotype male of *Priocnemis xenos* Kirby, 1883 is a melanic *S. fugax*, whereas the allotype is a female *Degithina huttonii* (Kirby, 1881), as noted by Turner (1915). Turner placed only the female of *xenos* in the synonymy of *Degithina huttonii* (Kirby, 1881).

Material examined. 2320 non-type adults (1350 females, 980 males) from Mt Unuwhao (latitude 34°26'S) to southern Stewart Island (47°15'S). Also 86 larvae and 78 pupae. Collection localities: see Text-figure 16.

Taken from sea level to at least 1500 m.

Adult females are present from October to May (Tautuku, SL), and are most abundant from December to February. Adult males are present from October to March, and are most abundant from November to February. Both sexes emerge earlier in the north (e.g., AK), and adults are present later in the south (e.g., SL).

Biology. HUNTING. *S. fugax* hunts on the ground in piles of leaves, in rotting logs, and in webs (such as those of Dictynidae) on tree bases. Spiders are

Text-fig. 16 Distribution of collection localities, *Sphictostethus fugax*.

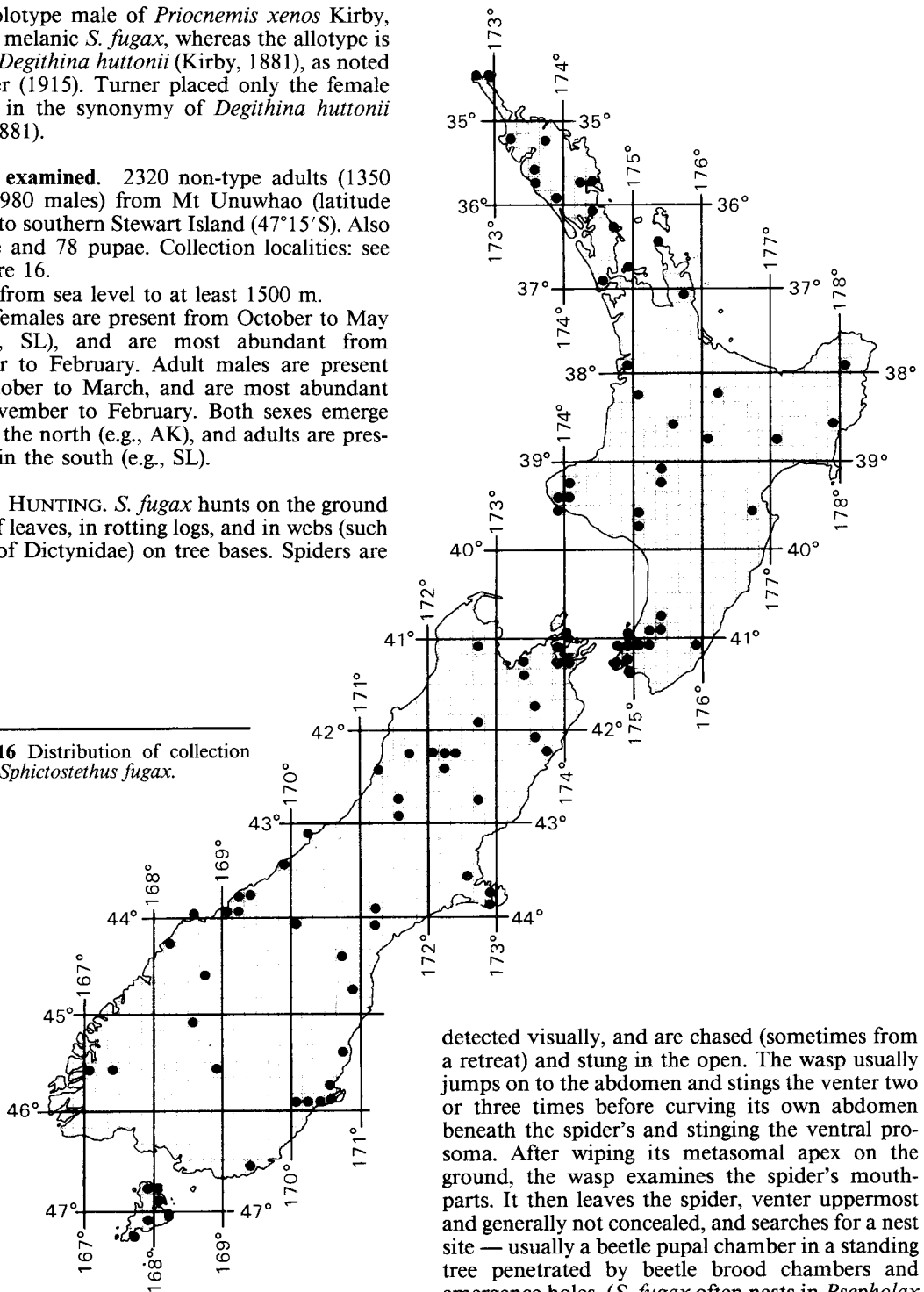

detected visually, and are chased (sometimes from a retreat) and stung in the open. The wasp usually jumps on to the abdomen and stings the venter two or three times before curving its own abdomen beneath the spider's and stinging the ventral prosoma. After wiping its metasomal apex on the ground, the wasp examines the spider's mouthparts. It then leaves the spider, venter uppermost and generally not concealed, and searches for a nest site — usually a beetle pupal chamber in a standing tree penetrated by beetle brood chambers and emergence holes. (*S. fugax* often nests in *Psepholax* holes in a rotten branch on a living tree, 20 m or

(17)

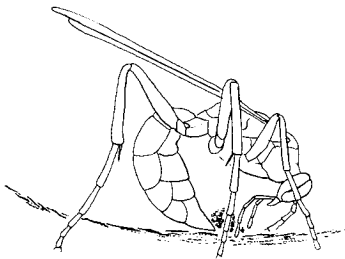

(18)

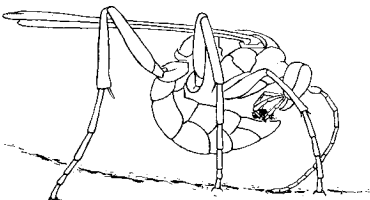

(19)

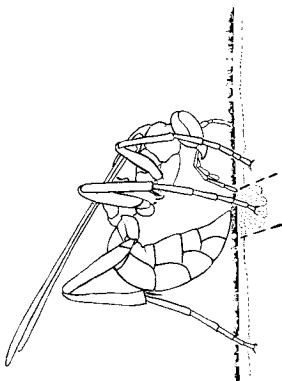

Text-fig. 17-19 *Sphictostethus fugax* manipulating mud during nesting: (17) scraping up moist mud with apex of abdomen; (18) transferring mud pellet to premental bristles; (19) forming outer seal of nest by smearing mud with apex of abdomen.

more above the ground.) The wasp then returns for the spider, re-examines its mouthparts, and hauls it to its nest, usually placing the spider at the very end of the burrow. After ovipositing it waits for 2.5-3 hours (or longer) before sealing the cell.

PARALYSIS is deep and permanent.

PREY CARRIAGE. Generally spiders are grasped by a third leg coxa, venter uppermost, and hauled backwards. Small spiders are carried forwards. *S. fugax* often climbs tree-trunks with a spider but then leaps to the ground with it. This species never amputates the legs of prey.

NIDIFICATION FORMULA. Prey - nest - egg - closure, and nest - prey - egg - (cell) closure.

NEST (Figures 198-200). Beetle pupal chambers in newly dead or living trees and shrubs are favoured nest sites (Harris 1974, table 41). Of 284 dissected nests, 256 were in burrows of *Psepholax* species (Curculionidae) and longhorns such as *Hybolasius cristatus* (Cerambycidae). This wasp occasionally nests in hollow stems, and readily nests in artificial trap nests with an internal diameter of 6-8 mm. Nest sites are frequently in forest margins or clearings, where sunlight penetrates to the ground. *S. fugax* is often common in diseased or damaged forest, where pupal chambers of beetles that attack injured, firm wood are abundant.

After oviposition, *S. fugax* first locates a mossy tree-trunk (often the one in which it nests), and with the apex of the metasoma, aided by the mandibles, it scrapes off moss, liverworts, bark fragments, fern spores, fibres, and other plant material. Curving its abdomen between its legs until it is under the head, it places the small pile of gleanings in the premental bristles on the underside of its head. With this it forms the dark, rough, fibrous, unmoulded inner part of the nest seal. It next flies to a puddle with clay or muddy sides, drinks, and then bends the abdomen forwards between its legs. The pygidium is used to gouge out mud (Text-figure 17), which is retained on the abdomen beside the flattened median longitudinal ridge. The abdomen is again bent forward between the legs until the pygidium is beneath the head (Text-figure 18), where mud is moulded into a ball with the aid of the palpi. As the wasp forms the ball it scrabbles frantically with the fore and middle legs, probably to maintain its balance. The pellet is then transferred to the premental bristles, which bend out around it, the curved ends acting as hooks to secure it against the underside of the head. The long labial palpi are wrapped around the pellet. The wasp now flies to its nest and applies the mud, smoothing it into a flat, slightly concave surface with the apex of the abdomen (Text-figure 19). The abdomen is bent forward between the legs to manipulate mud on the seal.

Most naturally occurring nests are single-celled, but in trap nests the wasp more often constructs several cells. My field data give the following cell numbers. Naturally occurring nests (total 284): 1 cell, 223; 2 cells, 47; 3 cells, 14; vestibular cells in 37 nests. Trap nests (total 119): 1 cell, 57; 2 cells, 38; 3 cells, 17; 4 cells, 6; 5 cells, 1; vestibular cells in 12 nests.

Cells have outer seals only; no inner seal is made. (The occasional presence of an inner seal indicates prior use of the site by a sphecid wasp.) A spider is placed in the burrow (usually with its legs extending in front), and the cell is sealed, often at the burrow entrance. Naturally occurring cells vary from 15 mm to 68 mm long. Their diameter at the mouth varies from 3.5 mm to 8.3 mm, widening to 3.9–9.0 mm in the internal pupal chamber. Sometimes an empty outer vestibule is sealed off from the cell with an additional thin plug of mud 1–2 (3.9) mm thick. Mud seals are complex, with two major parts. The dark brown inner part, 1.0–5.6 mm thick, is composed of plant material (moss, liverwort, plant fibres, scrapings of bark) similar to that in *S. calvus* plugs. The outer part consists of moulded mud (usually clay), its outer surface concave. The outer surface is sculptured to blend in with the texture of the wood surrounding the seal.

LIFE HISTORY. The parallel-sided, oblong-ovate egg, 1.8–2.2 mm long by 0.05–0.09 mm in diameter, is laid anterolaterally on the right or left of the host's abdomen (Figures 198–200). At 15°C eclosion occurs after 2–2.5 days. The fifth instar is attained after 13–15 days, and feeds rapidly for 14–24 hours, after which it lies supine with a glob of masticated chitin on its anterior abdominal sterna. It ceases eating, though the mouthparts work as it moves its head forward and back over the chitin mass. It remains thus for a further 12–14 hours before spinning its frail cocoon, first throwing out a network of supporting threads, and then revolving about its long axis. Some 46 days after the meconium is voided the prepupa is still faintly perceptible through the cocoon. Prepupal diapause lasts approximately 7 months.

The cocoon (Figure 212), 9–19 (13) mm long, is non-rigid, sub-pyriform, truncate at the narrow meconial end, and a faintly translucent pale cartridge buff; the walls are on average 0.01 mm thick at the middle. The thickness of the wall divided by the cocoon's width at the middle is 0.002. The wall (Figure 216) is thus very much thinner than that of any other pompilid cocoon in New Zealand, and the prepupa within is usually faintly visible. Structure is otherwise very similar to that of *nitidus* and *calvus* cocoons; for instance, as regards the tightly consolidated inner layer, and the outer layers with partly fused fibres in a matrix.

Remarks. Most of the nominal species listed here under synonymy were the result of limited collections, which concealed the clinal variations within *fugax*. Thus, *maculipennis* is distinguished primarily by a very reduced fascia on the forewing — a characteristic of Peel Forest specimens, which often lack a fascia altogether; and *xenos* and *huttonii* are southern melanics (see Variation, above).

Gribodo's (1884) description of *brownii* is quite unambiguous (e.g., his references to golden pile on the head and to the median epipygeal carina). He states that C. Brown sent him the specimen from Howick. The coleopterist Thomas Broun held the rank of captain at that time, and was stationed at the military barracks at Howick, Auckland. Cameron evidently recognised that Gribodo had misspelled Broun's name, and in 1903 amended the original orthography to *brouni*. Cameron was confused by Gribodo's generic placement, stating (1898, p. 48): "Under the name *Agenia brouni* [sic] Signor Gribodo describes a species ... which agrees closely ... with *S. wakefieldii* [sic], but the latter is a *Salius* and not an *Agenia*". Gribodo, however, had seemingly astutely recognised the many morphological specialisations for mud-using (such as the pygidial carina), for *fugax* has evolved convergently towards the mud-using tribe Auplopodini, to which *Agenia* belongs (see above).

In the past there has been some confusion over *Priocnemis xenos* Kirby, 1883. The name was established on the basis of one male and one female collected by F. W. Hutton. The male is a melanic *S. fugax*, while the female is an ichneumonid — *Degithina huttonii* Kirby, 1881. Although it might seem unusual that Kirby could describe the same insect as an ichneumonid in 1881 and as a pompilid in 1883, in the same paper he described the female of another New Zealand ichneumonid, *Pterocormus lotatorius* Fabricius, 1775, as a pompilid, viz *Priocnemis pascoei* Kirby, 1883.



Subfamily POMPILINAE

Diagnosis. ADULT. Metasoma without a transverse groove on 2nd sternum, and without a lateral incised line on 1st tergum (see Key-figure 1a). Other characters often present include: hind tibia with apical, fringing setae of unequal length, unevenly spaced, almost always splayed out; hind femur with small, grouped spines often set in pits on upper surface near apex; forewing 2nd medial cell with a pocket in lower basal corner (Figure 10); metapostnotum often small, or not visible in mid-dorsal view.

LARVA. Head and thorax with long setae, often as long as diameter of antennal orbits, or longer. Evans (1959b) tentatively suggested that absence on the venter of minute spicules that are present in Pepsinae might be of use in distinguishing Pompilinae. However, such spinules are present on *Epipompilus insularis* larvae.

Remarks. *Epipompilus insularis* Kohl, in tribe Epipompilini, is the sole representative of the Pompilinae in New Zealand.

Tribe Epipompilini

Diagnosis. ADULT. Labrum exerted. Frons in females projecting, markedly gibbous in midline just above antennal insertions, steeply and abruptly declivous between them and below, thus overhanging clypeus. Male antenna crenulate in lateral profile. Pronotum short or long. Legs unusually short. Both sexes with all legs very smooth, almost without spines and bristles. Female fore femur usually incrassate. Female foretarsal segments unusually short. Forewing sometimes with only 2 submarginal cells. Propodeum very smoothly rounded, narrowing posteriorly, the slope fairly low and even. Metasoma fusiform; male sometimes with brushes of hair on 4th and 5th sterna. Male genitalia with parameres rod-like, aedeagus simple, basal hooklets double. Sexual dimorphism great. Some species unusually brightly coloured.

LARVA. Head and thorax with very long setae, exceeding diameter of antennal orbits. Mandible of final-instar larva without 2 teeth close together at apex, but with at least 3 teeth. Spiracles with few internal spines. Dorsum of mesothorax with a raised, shield-shaped structure. Cocoon thick-walled, buff-coloured; fibres in outer layers very loosely connected. Nesting behaviour simple. Nidification formula: prey - egg.

Remarks. Haupt (1930) established tribe Epipompilini for *Epipompilus* Kohl, *Aulocostethus* Ashmead (a junior synonym of *Epipompilus*), and six other genera — *Idopompilus* Kohl, *Pseudoclavella* Haupt, *Dromochares* Haupt, *Gonaporus* Ashmead, *Taeniaporus* Haupt, and *Plagioceps* Haupt — which were shortly removed to another tribe. Evans (1961) transferred *Epipompilus* to tribe Aporini and suppressed tribe Epipompilini, stating that *Epipompilus* was so distinctive a genus that past workers would have placed it in a separate tribe "without question". Evans (1962, 1968, 1972, 1977) has since described many *Epipompilus* species from South America, Australia (including Tasmania), and New Guinea. Undescribed species from

Malaysia extend the diversity of *Epipompilus* even further. The multiplicity of form within this group is now seen to be far greater than is generally found within a single genus. However, the species fit together nicely as a distinctive, well characterised, clearly defined tribe. The relationships with *Aporus*-like species are unclear, but affinity with *Aporus* is probably not close.

Study of *E. insularis* reveals distinctive features in the larva, pupa, and cocoon so far not found in other Pompilidae. Tribe Epipompilini is therefore reinstated, with *Epipompilus* Kohl as its only genus. It should be placed first in Pompilinae, before Aporini.

Similarities (often superficial) occur between *Epipompilus* and the genera *Homonotus* Dahlbom, *Ferreola* Lepeletier, *Paraferreola* Susterer, *Ferreoloides* Haupt, *Platyderes* Guérin-Meneville, *Aporus* Spinola, *Chelaporus* Bradley, *Psorthaspis* Banks, and *Allaporus* Banks. For example, females of many of the foregoing genera have the legs smooth with few setae, forelegs short, fore femora incrassate, fore tarsi with very short segments, frons gibbous above and between the antennal bases and abruptly declivous below, forewings sometimes with two submarginal cells (e.g., *Aporus*), and antennae short. They hunt trapdoor spiders. *Ferreola* and *Paraferreola* resemble *Epipompilus* in having the labrum strongly exerted and the male antennae crenulate, and in behaviour; for example, *Ferreola thoracica* Rossi hunts female *Eresus niger* spiders in their own burrows, as well as wandering males, and simply affixes its egg to the spider, which is paralysed either briefly or not at all. No nest is made, nor is the host spider transported. In most other respects (e.g., wing venation, male genitalia) those two genera do not closely resemble *Epipompilus*. In most of the genera the labrum is not exerted, nor is the male antenna crenulate. The legs are much more spinose and setose, and in many other characters, including wing venation and male genitalia, there is no close resemblance to *Epipompilus*. Many of the similarities between *Aporus* and *Epipompilus* probably result from convergent evolution associated with oviposition on spiders within earth burrows, trapdoor nests, or silken retreats in very confined spaces, and through the females not making nests or transporting prey, and are probably not indicative of phylogenetic homology. Nevertheless, the affinities of *Epipompilus* almost certainly lie within this group of genera.

Genus *Epipompilus* Kohl

Epipompilus Kohl, 1884, p. 57. Type-species *Epipompilus maximiliani* Kohl, by subsequent designation (Ashmead 1900); Mexico.

Aulocostethus Ashmead, 1902, p. 133. Type-species *Aulocostethus bifuscatus* Ashmead, by original designation; "Peru".

Epicostethus Banks, 1947, p. 445. Type-species *Epicostethus williamsi* Banks, by original designation; "Banos, Oriente, Ecuador".

Epipompiloides Evans, 1961, p. 28. Type-species *Epipompilus insularis* Kohl, by original designation; New Zealand.

Diagnosis. ADULT. Labrum extensively exerted, broad. Pronotum with streptaulus absent or ill defined. Mesoscutellum and metanotum prominent medially; metanotum with lateral foveae. Propodeum smoothly rounded, evenly sloping. Legs with very few spines or bristles; female fore tibiae and tarsi without preapical spines; spines of apical row on fore tibia minute or absent; female fore femora usually incrassate; segments of female fore tarsus unusually short. Forewing with either 3 or 2 submarginal cells, the latter condition resulting from loss of either 1st or 3rd radiomedial cross-vein. Male subgenital plate broad basally, sometimes produced apically as a slender, hairy process; basal plate (8th sternum) unusually broad. Male genitalia with parameres simple, rod-shaped, often bearing long setae; basal hooklets double; aedeagus simple. Sexual dimorphism marked. Nesting behaviour simple: retreat-forming spiders oviposited on *in situ*; no nest made; spiders not transported.

FINAL-INSTAR LARVA. Head and thorax with very long setae; longest head seta exceeding diameter of antennal orbit. Mandible with 4 teeth, but lacking 2 teeth close together at apex. Mesothorax dorsally with a raised, shield-shaped, sulcate structure bearing 4–8 sclerotised tubercles or teeth. Spiracles round; atrium without spines; collar spines absent.

COCOON buff-coloured, very thick-walled, the fibres loosely connected; outer layers without a matrix or cement between fibres.

Remarks. Genus *Epipompilus* has a confused taxonomic history. Its first two species, described by Kohl in 1884, were *maximiliani* from Mexico and *insularis* from New Zealand. Ashmead (1900) designated *maximiliani* the type-species of the genus. In 1902 Ashmead revised *Epipompilus* and described a related genus, *Aulocostethus*, with *bifuscatus* Ashmead as type-species. Haupt (1930) established the tribe Epipompilini for these two genera plus several others. Both Ashmead and Haupt separated *Aulocostethus* and *Epipompilus* on whether or not the eyes were hairy, *Epipompilus* supposedly having naked eyes. Evans (1961) showed

Aulocostethus to be a junior synonym of *Epipompilus*, and that *maximiliani* has hairy eyes. However, Evans also established the new genus *Epipompiloides* for *insularis*, stating that it should be placed next to *Epipompilus* in the tribe Aporini. In 1962, after examining some Australian species, Evans synonymised *Epipompiloides* with *Epipompilus* but retained the former name for a subgenus of three species, with *insularis* the type-species. He distinguished males of the subgenus *Epipompiloides* by their possession of a broad subgenital plate tapering to a rounded apex. Yet Evans had not seen males of *insularis*, in which the subgenital plate is actually in the form of a "slender process arising from a broad base", as in Australian species of subgenus *Epipompilus*; nor indeed is the propodeum "wholly covered with strong reticulate sculpturing" (Evans 1962). While "not abandoning [his] subgeneric name entirely", Evans (1972) pointed out that it was difficult to place known males into his subgenera, and (still unfamiliar with the male of the type-species) now predicted that *Epipompiloides* males should have a slender, pointed subgenital plate. This is the reverse of his 1962 prediction, and probably a correct one, if the subgenus is retained. *E. insularis* has a subgenital plate of this last type, and indeed is very similar to males of subgenus *Epipompiloides* in the sense of Evans, 1972 (e.g., *E. bushi* Evans; Australia).

Epipompilus insularis Kohl

insularis Kohl, 1884, p. 57; 1886b, p. 340 (*Epipompilus*).

Haupt, 1930, p. 763 (*Epipompilus*). Evans, 1961, p. 28 (*Epipompiloides*); 1972, p. 116 (*Epipompilus* (*Epipompiloides*)). Pollard, 1982, pp. 37–39 (*Epipompilus*).

epipompilus Dalla Torre, 1897, p. 287 (*Pompilus*) (replacement name).

ADULT

Diagnosis. Female. Very small — body 6.0–8.0 mm long. Body black; wings yellow-tinted. Labrum extensively visible and appearing almost continuous with clypeus (cf. mostly hidden and set well back; Key-figure 2a, cf. 2b). Fore femora swollen, 2.6× as long as wide, and segments of fore tarsus unusually short (Key-figure 3a). Metasoma without a lateral incised line on 1st tergum and without a transverse groove on 2nd sternum (Key-figure 1a).

The foregoing characters distinguish *E. insularis* females from other New Zealand Pompilidae. By the following characters they may be distinguished from extralimital *Epipompilus* species: maxillary palpi short, segments 5 and 6 each shorter than median length of clypeus; eyes not hairy; apex of fore tibia with a series of small spines; forewing

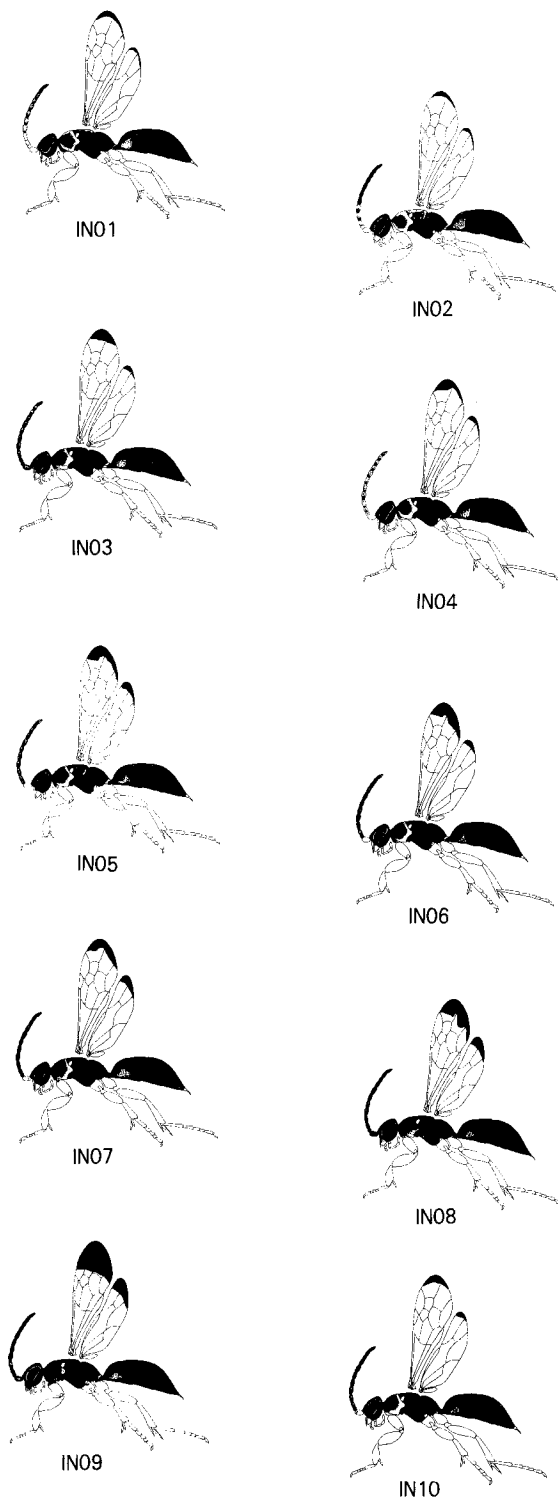

yellow-tinted, infuscated apically, always without a fascia.

MALE. Body black. Head with a marked, lemon-yellow paraoccipital spot above clypeus between eye and antennal socket. Wings clear hyaline. Antenna crenulate in lateral profile (Key-figure 4a). Subgenital plate broad basally, tapering to a slender process apically (in outline shaped like a fountain-pen nib), fringed with very long, apically hooked setae which occur as well on the disc (Figure 58).

The foregoing features readily distinguish *E. insularis* males from other New Zealand Pompilidae. By the subgenital plate (Figure 58) and genitalia (Figure 67) they may be distinguished from extralimital *Epipompilus* species.

Descriptions. Female (Figure 2). Length 6.0–8.8 mm; forewing 5.5–7.8 mm.

COLOUR AND VESTITURE. Head, mesosoma, and metasoma black. Legs except tarsi variable, grading from castaneous through brown to black; tarsi mostly castaneous. Forewing: proximal 0.7 hyaline tinged with yellow, distal 0.3 wholly lightly infuscated. Hind wing except tip hyaline, tinged with yellow; distal 0.15 lightly infuscated. Infuscated area on both wings variable. Stigma and veins mostly yellowish, translucent; apical parts sometimes infuscated. Pubescence silvery bronze to pale brown. Frons with some short, usually pale hairs; remainder of body except metasomal apex very sparsely hairy.

STRUCTURE. Head with maxillary palp short; segments 5 and 6 each shorter than median length of clypeus. Labrum strongly exerted, its apical margin rounded. Clypeus with margin very weakly elevated, apical margin weakly concave. Malar space slightly shorter than antennal segment 2. Antennae relatively short and thick. Frons moderately shining, closely covered with small but very distinct punctures; POL:OOL about 4:3. Pronotum of moderate length, its posterior margin subangulate. Entire thoracic dorsum and pleura with distinct, small punctures. Postnotum very narrow. Propodeum sloping evenly, without an impressed median line or other sculpturing. Fore femora swollen (see Key-figure 3a). Apex of fore tibia with a series of minute spines; middle and hind tibiae with a few very small spines on their outer surfaces, but none above. Forewing stigma large, $64\times$ as long as marginal cell; marginal cell removed from wing-tip by $0.8\times$ its own length. Cells *1Rs* and *2Rs* proportionately small; *3rm* greatly basad of apical

Text-fig. 20 (part) Selected, locally representative females of *Epipompilus insularis*; see map on p. 99.

end of marginal cell (i.e., even medially and posteriorly) (Figure 31).

Measurements: see Appendix 1, Table 2.

Male. Length 3.5–7.8 mm; forewing 2.8–7.0 mm.

COLOUR AND VESTITURE. Body and appendages almost entirely black; wings clear. Head and mesosoma black; face with a lemon-yellow paraoccipital spot bounded by eye, antennal socket, and frontoclypeal suture. Labrum, distal half of mandibles, palpi, and legs except tarsi dull blackish-brown; tarsi dull brown. Metasoma dark brown tinged with fuscous. Wings entirely clear hyaline; stigma and veins dark brown, some of them translucent (e.g., *1rm*, *2rm*, *3rm*, and *2mcu* on forewing). Pubescence silvery, grading into pale brown on dorsum of metasoma. Ventral surfaces of coxae, epicnemium, and episternum covered with thicker silvery pubescence, this becoming sparse laterally. Frons with short, erect hairs; remainder of body very sparsely hairy. Metasomal venter with a few scattered, stiff bristles.

STRUCTURE. Head: labrum strongly exerted, its apical margin less rounded than in female. Clypeus with apical margin concave. Malar space about half as long as antennal segment 2. Frons less forward-produced than in female, moderately nitid, closely covered with minute punctures; vertex gibbous. Front angle of antennal triangle greater than 90°; POL:OOL about 3:1. Thorax dorsally with minute punctures, shining. Propodeum minutely colliculate. Forewing stigma about 0.60× as long as marginal cell; marginal cell removed from wing-tip by about 0.90× its own length. Hind wing transverse median vein oblique, more curved than in female, often meeting median vein basad of cubital fork by half its own length; distal 0.8 of vein *cu* evanescent; scattered dots of pigment tracing outline of anal vein to wing margin. Subgenital plate (Figure 58a–c) in outline suggestive of a fountain-pen nib, with a long, narrow, attenuated distal portion arising from a broad base, the entire structure covered with very long, apically hooked setae.

Genitalia (Figure 67): parameres far exceeding parapenial lobes, bearing long, apically hooked setae; parapenial lobes simple, blunt, rod-like, also bearing long, hooked setae; digitus volsellaris simple, blunt-ended prong-shaped; aedeagus simple, terminating at roughly the same level as the 2 innermost paired structures.

Measurements: see Appendix 1, Table 2.

Variation (Text-figure 20). Generally, with increas-

Text-fig. 20 (part) Selected, locally representative females of *Epipompilus insularis*; see map on p. 99.

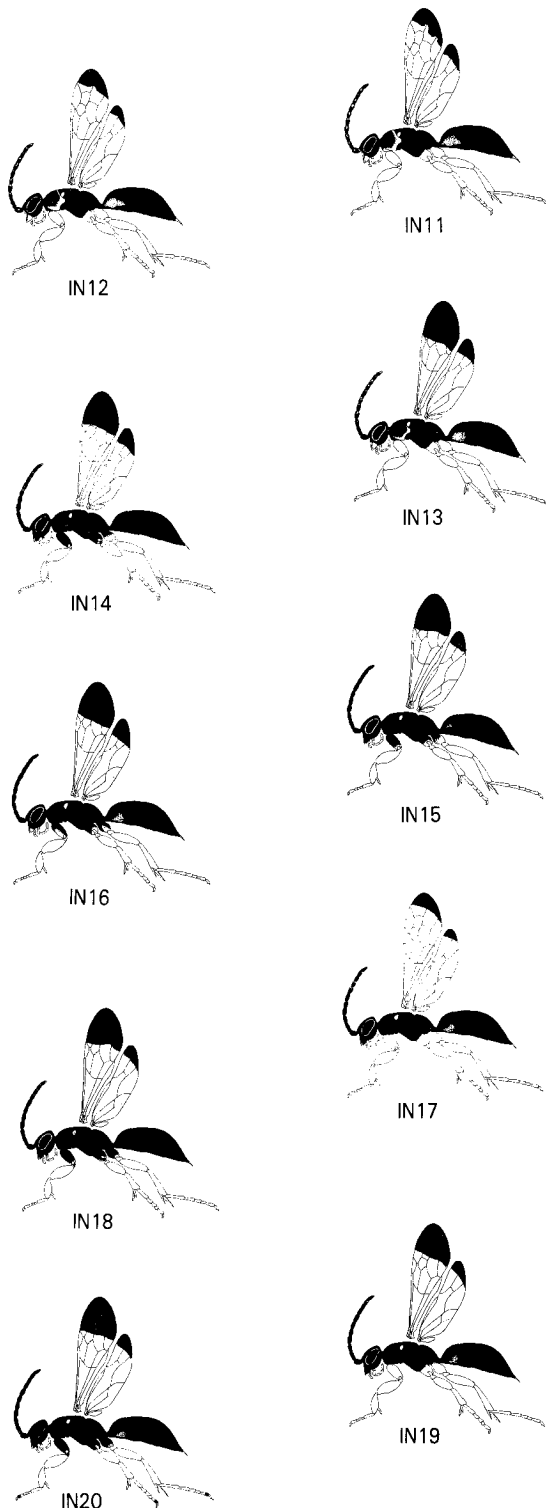

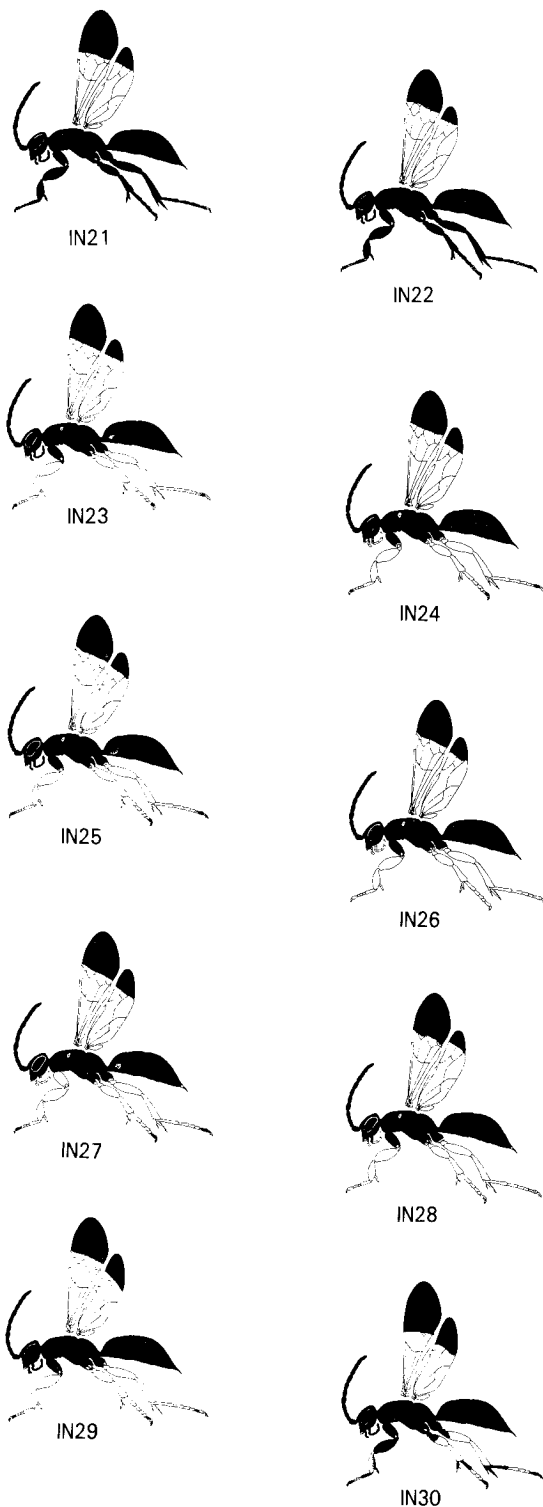

ing latitude females become proportionately darker and the apical infuscation of the wing increases in extent. Specimens from north of about latitude 36°S have the body mostly black, but with castaneous margins on many thoracic sutures and a broad, orange-castaneous band occupying most of the pronotal disc. The scutellum is often entirely orange-castaneous, e.g., on five specimens from Mangamuka Gorge (35°12'S) and two from Pukepoto (35°10'S), but in specimens from Spirits Bay (34°27'S) and south of latitude 36°S it is black. In the north, forewing infuscation is restricted to the extreme apical margin. The legs and antennal scape of Northland specimens are entirely bright orange-castaneous, and the palpi orange-fulvous. The antennal flagellum is brown above and pale brown below.

South of latitude 36°S (near Dargaville) the scutellum is black. The orange band on the pronotum, though often faintly perceptible to about latitude 42°S, becomes greatly reduced south of about Rotorua (38°S). In the eight Rotorua specimens it is very distinct, though reduced, crossing the pronotal disc at about its middle. Legs and palpi are entirely orange on all North Island specimens examined. Specimens from Nelson (41°16'S) vary considerably, some having the fore coxae completely black, while in others they are entirely bright orange-testaceous. South of Auckland (36°51'S) the antennal scape is very variable, ranging from bright orange-castaneous to black. On the southern side of Cook Strait (about 41°S) the forewing infuscation suddenly increases in size from 0.07–0.1 to 0.3 of the wing apex. In all specimens from between Christchurch (43°32'S) and Dunedin (45°53'S) it extends to just above the level of the stigma, in southern melanics to just below it. Between Christchurch and Dunedin all coxae may be either castaneous or black, and the remainder of the legs castaneous, though the fore femur sometimes has a black spot of very variable size. Coxal infuscation affects first the fore pair, then the middle, then the hind. In this latitudinal band, and at Arthur's Pass (42°57'S), the palpi vary between straw-coloured and fulvous; between Timaru (44°24'S) and Dunedin they may be fulvous or lightly infuscate. At a boundary somewhere north of Haast Pass (44°S), Pleasant Flat (Haast River), Lake Moeraki (43°44'S), Haast (43°52'S), and Jackson Bay (44°S) fully melanic forms are suddenly encountered, and these have the body (including clypeus and labrum), palpi, and all parts of the legs entirely black. This form occurs throughout Fiordland and on Stewart Island (46°41'S to 47°17'S).

Text-fig. 20 (part) Selected, locally representative females of *Epipompilus insularis*; see map on p. 99.

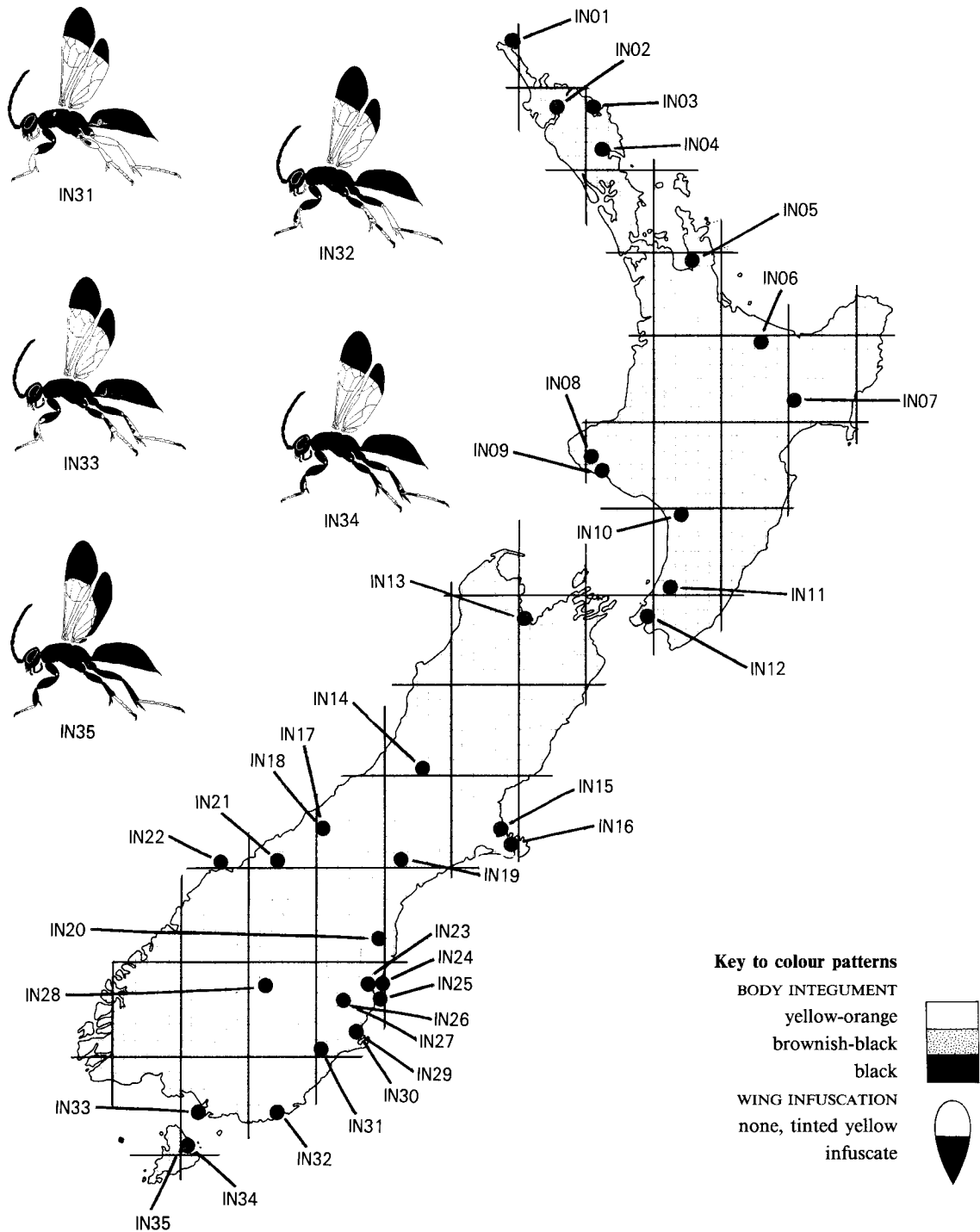

Text-fig. 20 (part) Selected, locally representative females of *Epipompilus insularis* and their place of origin.

Structural variation is minor. Some specimens from Pleasant Flat (about 44°S) have an obsolete median carina and a pair of shallow, 'V'-shaped impressions on the hind slope of the propodeum that is absent from most others. The section of *M+Cu1* between *Cu-a* and the *Cu1/M* bifurcation on the hind wing is longer in Pleasant Flat melanics than in most others; however, it is always very variable in length.

In the male, colour is constant throughout the species' range, and all specimens examined are structurally very similar. For instance, the subgenital plates of specimens from Kelsey's Bush, Waimate (44°42'S) are almost indistinguishable from those of Auckland examples. There is a slight tendency for the attenuated apical part to lengthen relative to the base south of Christchurch.

FINAL-INSTAR LARVA

Diagnosis. Head with setae of vertex and temples unusually long, exceeding diameter of antennal orbits by 1.1×. Mandibles with 3 or 4 teeth, but lacking closely paired teeth at apex. Labrum with 10–12 setae. Clypeus with a continuous band of 10–12 setae. Body with very long setae, particularly on thorax. Second thoracic segment bearing dorsally an elevated, rounded, sulcate structure near centre which, under transmitted light especially, is seen to bear 4–8 chitinous tubercles, or teeth, arranged in an irregular ring.

Larva always above ground, in a small, concealed space, within a spider's silken retreat, without a sealing plug of mud or any form of nest closure. Sometimes on an active, apparently normal spider.

NOTE. The dorsal structure on the 2nd thoracic segment, the very long head setae, and the mandibles with 3 or 4 teeth but without paired apical teeth of approximately equal development readily distinguish this larva from all other New Zealand Pompilidae, and have not previously been described in Pompilidae.

Description (based on a specimen from Dean's Bush, MC, Christchurch, 14 Apr 1972). Length 6.5 mm.

Body (Figure 75) with pleural lobes small; supra-anal lobe larger than suranal lobe, protuberant. Integument with setae ranging from long (84 µm) to short (8 µm), the different sizes often occurring together (Figure 88). Spicules on venter of prothorax ranging from 5.0 µm to 8.4 µm long (Figure 89). Mesothorax dorsally with an asymmetrical raised, rounded structure (revealing under transmitted light a central sulcus and a lateral sulcus on either side) bearing 8 sclerotised, tooth-like, erect tubercles arranged in an uneven ring (Figures 110,

111).

Spiracles round. First thoracic spiracle (Figure 100a,b) 54 µm in diameter; atrium internally with almost regularly anastomosing ridges lacking spines; opening into subatrium round; subatrium much narrower than atrium. Second thoracic spiracle (Figure 109) reduced (atrium 40 µm in diameter), similar to prothoracic spiracle and with internal anastomosing ridges, but without a distinct subatrium.

Head (Figure 122): height 902 µm; maximum width 825 µm; HW/HH 1.16. Parietal bands well defined, moderately short, 374 µm long. Antennal orbits 68 µm wide; outer rim round, sharply raised above surface of frons. Antennal papilla (Figure 129) 20 µm long, with 3 apical sensillae. Head setae unusually long, the longest 76 µm; LS/OD 1.1. Clypeus with a deep, median, vertical sulcus, widest and deepest basally, and with a central row of 10 evenly spaced setae resembling those on labrum. Labrum (Figure 140) 172 µm wide, 76 µm in median height, with 10 setae and 10 large, submarginal, pigmented sensory cones; outer margins converging towards centre at about 24°, hence base much wider than apex; outer apical angle of lateral lobes sharply angulate; apical margin concave; median lobe very small, notably convex; median sulcus small. Epipharynx (Figure 151) with grouped spicules, each bearing 4–6 apical points, on most of disc and at base; median area at apex with small, blunt spicules; lateral areas each with 6 conspicuous sensillae, the paired apical ones close together on either side, arising from round basal plates. Mandibles (Figure 158a–d) 319 µm long, 198 µm in maximum width, attenuated in appearance, with a small lateral seta; apex terminating in a single (i.e., unpaired) tooth; 3 or 4 subapical teeth; apical half deeply pigmented, remainder creamy white. Labium and maxillae, Figure 169; maxillae with long setae; lacinial area not notably produced; maxillary palpi 44 µm long, terminating with a large sensory cone surrounded by 5–7 smaller cones; galeae 44 µm long, much narrower than maxillary palp, with 2 large, equal, apical sensory cones; prementum of labium broad; labial palpi 8 µm long, 6 µm wide at base; spinneret 115 µm wide, with only 1 seta on either side. (**NOTE.** There is only one seta that would qualify as a 'spinneret seta' as described by Evans (1959). However, distortion can bring the seta on the innermost side of the palp down into this position.)

Variation. Many specimens have 12 labral setae and 12 large, pigmented sensory cones (cf. 10 and 10, as described above), though some have fewer than 10 labral setae. The clypeal setae are variable, numbering 6–10 (often 9) in the row. Total length

ranged from 3 mm to 12 mm, with a mean of 6.3 mm (37 specimens). Larvae of all instars have the sulcate, rounded structure on the dorsal mesothorax, but in instar 5 this bears 4, 6, or (usually) 8 'teeth'.

Type data. **Syntypes:** 4 females, New Zealand (NHMW). In the entomological collections of the Naturhistorisches Museum, Vienna, Austria there are "four examples labelled 'N. Seeld. 1882. 11.', 'insularis K. det. Kohl', 'Type' (red label). These examples must be considered as syntypes; they are in a rather good condition. No specimen is designated as holotype or lectotype" (Dr M. Fischer, pers. comm, 18 Jul 1984).

Material examined. 689 non-type adults (406 females, 283 males), from Mt Unuwhao (latitude 34°26'S) to Port Pegasus (47°14'S). Also 397 larvae, from ND, WN / NN, MB, MC, SC, DN, FD / SI. Collection localities: see Text-figure 21.

Taken from sea level to at least 2000 m (e.g., The Remarkables range, CO).

Adult females were present from November to May, and adult males from November to March.

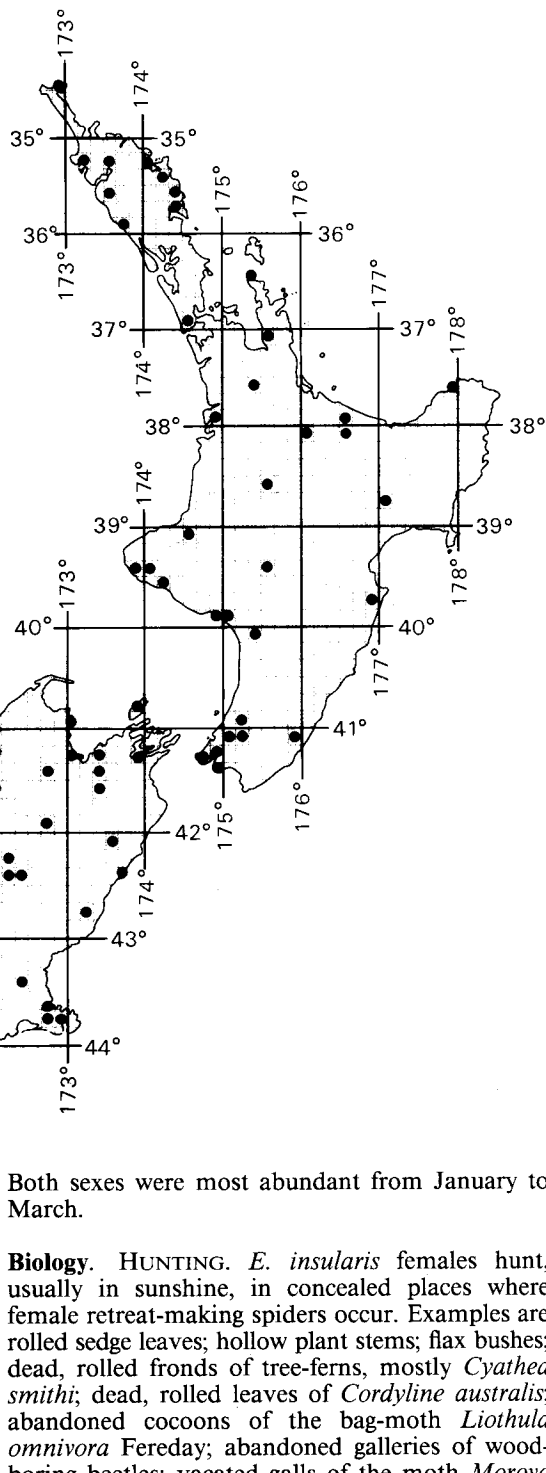

Text-fig. 21 Distribution of collection localities, *Epipompilus insularis*.

Both sexes were most abundant from January to March.

Biology. **HUNTING.** *E. insularis* females hunt, usually in sunshine, in concealed places where female retreat-making spiders occur. Examples are rolled sedge leaves; hollow plant stems; flax bushes; dead, rolled fronds of tree-ferns, mostly *Cyathea smithi*; dead, rolled leaves of *Cordyline australis*; abandoned cocoons of the bag-moth *Liothula omnivora* Fereday; abandoned galleries of wood-boring beetles; vacated galls of the moth *Morova subfasciata* (Walker) in *Muehlenbeckia australis*;

and beneath bark on tree trunks. Extensive data on spider nest sites are summarised in Harris (1974, table 40); and Pollard (1982) describes sites recorded in his own study of *E. insularis* hosts.

PREY CAPTURE. In captivity, *E. insularis* runs at the jumping spider *Trite auricoma* (Urquhart), which assumes a defensive stance. The wasp lays its egg on the spider, then moves away. A short time later the spider moves about as before. Spiders parasitised while sitting on egg-batches, on the other hand, seldom move from their eggs.

PARALYSIS is light and of short duration, or non-existent.

NIDIFICATION FORMULA. Prey - egg.

NEST. No nest is made. However, the fact that *E. insularis* typically oviposits on retreat-dwelling female host spiders implies a degree of protection for the egg by association.

BEHAVIOUR OF HOST. Parasitised hosts are usually capable of normal movement shortly after acquiring an *E. insularis* egg. Some spiders — e.g., *Trite planiceps* (Simon), *T. auricoma* — are parasitised while on top of a silken cocoon containing eggs. Others, e.g., *Clubiona* species, are parasitised while on an egg batch inside a silken cocoon. Others again (but without eggs) are parasitised within a retreat. Yet others, though less commonly, are parasitised away from a retreat, but often subsequently spin one around themselves and the parasitoid. In the laboratory, spiders parasitised away from retreats run about apparently normally until at least day 11 (from parasitisation), or until the parasitoid is halfway through instar 4. About day 2 or 3 the host spider usually spins a silken retreat. Some spiders leave their retreats from time to time, run about, and make additional retreats if the first is damaged. The spider often seals itself completely within a retreat before the parasitoid moults into instar 4. Gravid hosts sometimes lay eggs within the retreat up to about day 6. If the retreat is opened the spider will run out, even when carrying a late 4th-instar parasitoid.

E. insularis larvae can withstand considerable host movement. Whereas larvae in instars 1–4 suck from the host's abdomen, 5th-instar larvae actively chew, and move about considerably. When host eggs are present, they are often eaten by the maturing larva after it has eaten the spider's abdomen. The larva will then often eat some of the legs but leave the prosomal exoskeleton, as happens when eggs are laid on hosts already on egg batches within retreats.

LIFE HISTORY. The white, curved, oblong-ovate egg, 1.2 mm long, is laid anterolaterally on the host spider's abdomen (478 observations) (Figure 201). Eclosion of eggs laboratory-reared at about 14°C occurs 3 days after laying. The larva moults into

instar 2 on day 8, instar 3 on day 11, instar 4 on day 13, and instar 5 on day 15; it finishes feeding on day 16. Cocoon-spinning begins on day 17 and finishes on day 21–22. The meconium is voided on day 19, after which the larva resembles a prepupa, with clearly defined lateral lobes. Life history stages usually take longer in the field. Prepupal diapause lasts about 7 months.

Cocoons (Figure 213) are rigid, pyriform, often rounded at either end, sometimes truncated at the meconial end, pale cartridge-buff to very pale buff, and 6–12 (8.7) mm long; the wall (Figure 217) is on average 0.12 mm thick at the middle. The thickness of the wall divided by the cocoon's width at the middle is 0.056, over 5.5 times the equivalent value for cocoons of any other pompilid species in New Zealand. The inner cocoon wall is tightly consolidated. Fibres in the thick outer layers are not fused in any way, nor is there any matrix between them. Cocoons occur above ground, usually in the silken retreats of the hosts (Figure 202). The pupa is illustrated in Figure 219.

REFERENCES

- Anon. in d'Orbigny, C. 1848: Dictionnaire universel d'histoire naturelle. Paris, Renard, Martinet et cie. 816 p.
- Arens, L. E. 1948: An attempt at the comparative analysis of the evolution of some innate forms of behaviour in burrowing wasps, Bembicinae. *Compte rendu de l'Academie des Sciences de l'URSS (n.s.) B2*: 275–276.
- Arnold, G. 1936: The Psammocharidae of the Ethiopian Region. *Annals of the Transvaal Museum* 18 (4): 415–460.
- 1951: Sphecidae and Pompilidae (Hymenoptera) collected by Mr K. M. Guichard in West Africa and Ethiopia, 1941–1948. *Bulletin of the British Museum (Natural History), entomology* 2: 95–183.
- Ashmead, W. H. 1900: Classification of the fossorial, predaceous and parasitic wasps, or the superfamily Vespoidea. *The Canadian entomologist* 32: 145–155, 185–188, 295, 296.
- 1902: Classification of the fossorial, predaceous and parasitic wasps, or the superfamily Vespoidea. *The Canadian entomologist* 34 (6): 131–137.
- Banks, N. 1933: New Psammocharidae from the United States. *Psyche (Cambridge, Massachusetts)* 40: 1–19.
- 1947: Studies of South American Psammocharidae. Part 1. *Bulletin of the Museum of Comparative Zoology, Harvard* 99: 371–486.
- Bolton, B. 1973: The ant genus *Polyrachis* F. Smith in the Ethiopian region (Hymenoptera: Formicidae).

- Boulangé, H. 1924: Recherches sur l'appareil copulateur des Hyménoptères et spécialement des Chalastogastres. *Memoires et travaux de la Société Industrielle du Nord de la France, Lille* 28: 1-444.
- Brown, W. L.; Kempt, W. W. 1969: A revision of the Neotropical decetine ant genus *Acanthognathus* (Hymenoptera: Formicidae). *Psyche (Cambridge, Massachusetts)* 76: 87-109.
- Buller, W. L. 1877: Insect architecture, or notes on the habits of the black spider wasp of New Zealand. *Transactions and proceedings of the New Zealand Institute* 9: 343-347.
- Cameron, P. 1898: Notes on a collection of Hymenoptera from Greymouth, New Zealand, with descriptions of new species. *Memoirs and proceedings of the Manchester Literary and Philosophical Society* 42: 1-53.
- 1900: Description of a new species of *Halictus* (Andrenidae) from Christchurch, New Zealand. *Transactions and proceedings of the New Zealand Institute* 32: 17-19.
- 1901: On a collection of Hymenoptera made in the neighbourhood of Wellington by Mr G. V. Hudson, with descriptions of new genera and species. *Transactions and proceedings of the New Zealand Institute* 33: 104-120.
- 1902: Note on two probably introduced parasitic Hymenoptera in New Zealand. *Memoirs and proceedings of the Manchester Literary and Philosophical Society* 46: xxv-xxxii.
- 1903: A list of the Hymenoptera of New Zealand. *Transactions and proceedings of the New Zealand Institute* 35: 290-299.
- Christ, J. L. 1791: Naturgeschichte, klassifikation und nomenclatur der insekten vom bienen, wespen und amei songeschlecht; als der funften klasse funfte ordnung des Linneischem naturasystems von der insekten: Hymenoptera. Mit hautigen flügeln ... Frankfurt am Main, Hermannischen Buchhandlung. 539 p. and atlas.
- Child, J. 1974: New Zealand insects. Auckland, Fontana Periwinkle. 96 p.
- Crosby, T. K.; Dugdale, J. S.; Watt, J. C. 1976: Recording specimen localities in New Zealand: an arbitrary system of areas and codes defined. *New Zealand journal of zoology* 3: 69 + map.
- Dalla Torre, K. W. von 1897: Catalogus Hymenopterorum hucusque descriptorum systematicus et synonymicus; vol. viii, Fossores. Lipsiae, Engelmann. viii + 749 p.
- Day, M. C. 1984: Male polymorphism in some Old World species of *Cryptocheilus* Panzer (Hymenoptera: Pompilidae). *Zoological journal of the Linnean Society* 80: 83-101.
- Ducke, A. 1914: Über Phylogenie und Klassifikation der sozialen Vespiden. *Zoologische Jahrbücher, Jena: Abteilungen für Systematik, Ökologie und Geographie der Tiere* 36: 303-330.
- Duncan, C. D. 1939: A contribution to the biology of North American vespine wasps. *Stanford University publications, biological sciences* 8 (1): 1-272.
- Emery, C. 1894: Ueber Entstehung des Soziallebens bei Hymenopteren. *Biologisches Centralblatt (Leipzig)* 14: 21-23.
- Evans, H. E. 1948: Biological notes on two species of *Anoplius* (Hymenoptera: Pompilidae). *Entomological news* 59: 180-184.
- 1949: The strange habits of *Anoplius depressipes* Banks: a mystery solved. *Proceedings of the Entomological Society of Washington* 51: 206-208.
- 1950: A taxonomic study of the Nearctic spider wasps belonging to the tribe Pompilini (Hymenoptera: Pompilidae). Part I. *Transactions of the American Entomological Society (Philadelphia)* 75: 133-270.
- 1951a: A taxonomic study of the Nearctic spider wasps belonging to the tribe Pompilini (Hymenoptera: Pompilidae). Part II: genus *Anoplius* Dufour. *Transactions of the American Entomological Society (Philadelphia)* 76: 207-361.
- 1951b: A taxonomic study of the Nearctic spider wasps belonging to the tribe Pompilini (Hymenoptera: Pompilidae). Part III. *Transactions of the American Entomological Society (Philadelphia)* 77: 203-330.
- 1953: Comparative ethology and the systematics of spider wasps. *Systematic zoology* 2 (15): 155-172.
- 1958: The evolution of social life in wasps. *Proceedings of the 10th International Congress of Entomology* 2: 449-457.
- 1959a: Studies on the larvae of digger wasps (Hymenoptera, Sphecidae). Part V: conclusion. *Transactions of the American Entomological Society (Philadelphia)* 85: 137-191.
- 1959b: The larvae of Pompilidae (Hymenoptera). *Annals of the American Entomological Society* 52: 430-444.
- 1961: A reconsideration of the genus *Epipompilus* (Hymenoptera: Pompilidae). *Psyche (Cambridge, Massachusetts)* 68 (1): 25-37.
- 1962a: The genus *Epipompilus* in Australia (Hymenoptera: Pompilidae). *Pacific insects* 4 (4): 773-782.
- 1962b: The evolution of prey-carrying mechanisms in wasps. *Evolution* 16: 468-483.
- 1966: The comparative ethology and evolution of the sand wasps. Cambridge (Mass.), Harvard University Press. 526 p.
- 1967: Studies on Neotropical Pompilidae (Hymenoptera). III. Additional notes on *Epipompilus* Kohl. *Breviora* 273: 1-15.

- 1968: Studies on Neotropical Pompilidae (Hymenoptera). IV. Examples of dual sex – limited mimicry in *Chirodamus*. *Psyche* (Cambridge, Mass.) 75 (1): 1–22.
- 1969: Studies on Neotropical Pompilidae (Hymenoptera). V. *Austrochares* Banks. *Psyche* (Cambridge, Mass.) 76 (1): 18–28.
- 1972: Revision of the Australian and New Guinean species of *Epipompilus* (Hymenoptera: Pompilidae). *Pacific insects* 14 (1): 101–131.
- 1977: Studies on neotropical Pompilidae (Hymenoptera). X, Supplementary notes. *Psyche* (Cambridge, Mass.) 82 (3–4): 263–270.
- Evans, H. E.; Eberhard, M. J. 1970: The wasps. Ann Arbor, University of Michigan Press. 265 p.
- Evans, H. E.; Lin, C. S. 1956: Studies on the larvae of digger wasps (Hymenoptera: Sphecidae). Part 1: Sphecinae. *Transactions of the American Entomological Society (Philadelphia)* 81: 131–153.
- Evans, H. E.; Matthews, R. W. 1973: Behavioural observations on some Australian spider wasps (Hymenoptera: Pompilidae). *Transactions of the Royal Entomological Society of London* 125 (1): 45–55.
- Evans, H. E.; Yoshimoto, C. M. 1962: The ecology and nesting behaviour of the Pompilidae (Hymenoptera) of the north-eastern United States. *Miscellaneous publications of the Entomological Society of America (Philadelphia)* 3: 65–119.
- Fabricius, J. C. 1775: *Systema entomologiae*. Flensburgi et Lipsiae.
- 1781: *Species insectorum*. Hamburgi et Kilonii.
- 1787: *Mantissa insectorum*. Hafniae.
- 1793: *Entomologia systematica emendata et aucta*, vol. 2. Copenhagen. viii + 519 p.
- 1794: *Entomologia systematica emendata et aucta*, vol. 4. Copenhagen. viii + 472 p.
- 1798: *Supplementum entomologiae systematicae*. Copenhagen. iv + 572 p.
- 1804: *Systema piezatorum*. Brunswick. xiv + 439 p.
- Forbes, J.; Hagopian, M. 1965: The male genitalia and terminal segments of the ponerine ant *Rhytidoponera metallica* F. Smith (Hymenoptera: Formicidae). *New York Entomological Society Journal LXXIII*: 190–194.
- Ford, F. C.; Forbes, J. 1980: Anatomy of the male reproductive systems of the adults and pupae of the doryline ants *Dorylus (Anomma) wilvorthi* Emery and *D. (A.) nigricans* Illiger. *New York Entomological Society Journal LXXXVIII*(2): 133–142.
- Fox, K. J. 1974: Egmont National Park. *New Zealand's nature heritage* 1 (5): 136–141.
- Froggatt, W. W. 1907: Australian insects. Sydney, William Brooks. 449 p.
- Gibbs, G. W.; Ramsay, G. W. 1961: Lowland insects on mountain tops. *New Zealand entomologist* 2 (5): 4–6.
- Gmelin, J. F. 1790: Caroli Linnei systema naturae. Editio decima tertia, aucta reformata cura J. F. Gmelin. Vol. 1 (4–5). Lipsiae.
- Gourlay, E. S. 1927: Notes on the New Zealand wood-wasp *Ophrynopus schauinslandi* Ashmead. *Transactions and proceedings of the New Zealand Institute* 57: 691–693.
- 1964: Notes on New Zealand insects and records of introduced species. *New Zealand entomologist* 3 (3): 45–51.
- Grandi, G. 1971: I concetti di “monopodoichia” e di “polipodoichia” nell’ambito delle cure parentali degli imenotteri Aculeati solitari, con particolare riguardo al comportamento dei Pompilidi. Pp. 201–213 in Asahina, S., et al. (eds), *Entomological essays to commemorate the retirement of Prof. K. Yasumatsu*. Tokyo, Hokuryukan Publishing Co.
- Gribodo, G. 1884: Diagnosi di nuove specie di imenotteri scavatori. *Bolletino della Società Entomologica Italiana (Firenze)* 16: 275–284.
- Guérin-Ménéville, F. E. 1830: Sect. 1, Zoologie – Insectes. In: Duperrey, L. I. (1825–30), *Voyage autour du monde, exécuté par ordre du roi, sur la corvette de S.M. Coquille, pendant les années 1822–25*. Paris, A. Bertrand.
- Guiglia, D. 1948: I tipi di Imenotteri del Guérin esistenti nelle collezioni del Museo di Genova. *Annali del Museo Civico di Storia Naturale di Genova* 63: 175–191.
- 1961: Le specie di Imenotteri descritte da Luigi Masi. *Annali del Museo Civico di Storia Naturale di Genova* 72: 234–248.
- Harris, A. C. 1974: A systematic revision of the New Zealand Pompilidae (Hymenoptera) with studies on larvae, life histories, distribution, variation, paleogeography, hybrid zones, mimicry, and environmental melanism. Unpublished MSc thesis, Victoria University of Wellington library.
- 1978: Mimicry by a longhorn beetle of its hymenopteran parasitoid. *New Zealand entomologist* 6 (4): 406–408.
- 1982: On malaise traps and collecting bags. *Sphecos* 5: 10–12.
- Haupt, H. 1930: Die Einordnung der mir bekannten Psammocharidae. *Mitteilungen aus dem Zoologischen Museum in Berlin* 16 (5): 673–797.
- 1937: Beitrag zur Kenntnis der Psammochariden-Fauna Australiens (Spinnenfangende Wegwespen). Subf. Clavelinae Hpt. trib. Calicurgini nov. *Zeitschrift für Naturwissenschaften* 91: 121–136.
- 1938: Zur Kenntnis der Dryinidae. 1. *Zeitschrift für Naturwissenschaften, Halle (u.a.)*, 92: 13–34.

- 1959: Elemente einer systematischen Aufteilung der Macromerinae m. (Hymenoptera: Sphec-
oidea) fam. Pompilidae, subfam. Macromerinae.
Nova acta Leopoldina (n.s.) 21 (141): 1-74.
- 1962: The Pompilidae of Israel. *Bulletin of the
Research Council of Israel (B)* 11 : 3-70.
- Hudson, G. V. 1892: An elementary manual of New
Zealand entomology; being an introduction to the
study of our native insects. London, West New-
man & Co. 128 p.
- 1914: Evidence of memory and reasoning in a
pompilid. *Entomologist's monthly magazine* 50 :
121.
- 1934: New Zealand beetles and their larvae.
New Zealand, Ferguson & Osborn Ltd. 236 p.
- 1950: Fragments of New Zealand entomology.
Wellington, Ferguson & Osborn Ltd. 188 p.
- Hutton, F. W. 1874: List of the insects recorded as having
been found in New Zealand previous to the year
1870. *Transactions and proceedings of the New
Zealand Institute* 6: 158-171.
- 1881: Catalogues of the New Zealand Diptera,
Orthoptera, Hymenoptera; with descriptions of the
species. Wellington, Colonial Museum and Geo-
logical Survey of New Zealand. 132 p.
- (ed.) 1904: Index faunae Novae Zealandiae.
London, Dulau & Co. 372 p.
- Iwata, K. 1942: Comparative studies on the habits of soli-
tary wasps. *Tenthredo* 4 : 1-146.
- Janvier, H. (M. F. Claude-Joseph) 1930: Recherches bio-
logiques sur les prédateurs du Chili. *Annales des
sciences naturelles, zoologie et biologie animale* 10
(13) : 235-354.
- Kirby, W. F. 1881: A list of the Hymenoptera of New
Zealand. *Transactions of the Entomological Society
of London*, 1881 : 35-50.
- 1883: Notes on new or little-known species of
Hymenoptera, chiefly from New Zealand. *Trans-
actions of the Entomological Society of London*,
1883 : 199-203.
- 1884a: A list of the Hymenoptera of New
Zealand. *New Zealand journal of science* 2 : 65-
77.
- 1884b: Notes on the Diptera of New Zealand,
supplementary to Prof. Hutton's last catalogue of
1881. *Transactions of the Entomological Society of
London*, 1884 : 269-275.
- Kohl, F. F. 1884: Die Gattungen der Pompiliden. *Ver-
handlungen der Zoologische-botanischen Gesell-
schaft in Wien* 34 : 33-58.
- 1886: Neue Pompiliden in den sammlungen
des K.K. Naturhistorischen Hofmuseums. *Ver-
handlungen der Zoologische-botanischen Gesell-
schaft in Wien* 36 : 307-346.
- 1905: Hymenopteren typen aus der neotropi-
schen Fauna. *Verhandlungen der Zoologische-
botanischen Gesellschaft in Wien [?vol.]* : 338-366.
- Krombein, K. V. 1952: Biological and taxonomic obser-
vations on the wasps in a coastal area of North
Carolina (Hymenoptera: Aculeata). *Wasmann
journal of biology* 10 : 257-341.
- Kurczewski, F. E.; Kurczewski, E. J. 1968a: Host records
for some North American Pompilidae (Hymeno-
ptera) with a discussion of factors in prey selection.
Journal of the Kansas Entomological Society 41 :
1-33.
- 1968b: Host records for some North American
Pompilidae (Hymenoptera). First supplement.
Journal of the Kansas Entomological Society 41 :
376-382.
- 1972: Host records for some North American
Pompilidae (Hymenoptera). Second supplement:
tribe Pepsini. *Journal of the Kansas Entomological
Society* 45 : 181-193.
- Laing, D. J. 1973: Prey and prey capture in the tunnel-
web spider *Porrhothele antipodiana*. *Tuatara* 20 (2):
57-64.
- 1975: The postures of the tunnel-web spider
Porrhothele antipodiana: a behavioural study.
Tuatara 21 (3) : 108-120.
- 1978: Studies on populations of the tunnel-web
spider *Porrhothele antipodiana*. *Tuatara* 23 (2) : 67-
81.
- 1979: Studies on populations of the tunnel-web
spider *Porrhothele antipodiana*. Pt II. Relationship
with hunting wasps. *Tuatara* 24 (1) : 1-21.
- Lanham, U. R. 1951: Review of the wing venation of the
higher Hymenoptera (suborder Clitogastra), and
speculations on the phylogeny of the Hymeno-
ptera. *Annals of the Entomological Society of Amer-
ica (Philadelphia)* 44 : 614-628.
- Leclercq, J. 1952: Problèmes zoogéographiques posés à
l'occasion d'une monographie des Hyménoptères
crabroniens. *Transactions of the 9th International
Congress of Entomology* 1 : 576-582.
- Lichtenstein, A. A. H. 1796: Catalogus Musei Zoologici
Ditissimi Hambergi ... auctoris lege distrahendi.
Sectio tertia: Insecta. Hamburg. 224 p.
- Malyshev, S. I. 1966: Genesis of the Hymenoptera and
the phases of their evolution. London, Methuen.
319 p.
- Maneval, H. 1936: Nouvelles notes sur divers Hyméno-
ptères et leurs larves. *Revue française d'entomo-
logie (Paris)* 3 : 18-32.
- 1939: Notes sur les Hyménoptères (6^e série).
*Annales de la Société Entomologique de France
(Paris)* 108 : 49-108.
- Masner, L. 1968: A new genus of Scelionidae (Hymeno-
ptera) with austral disjunctive distribution. *New
Zealand journal of science* 11 : 652-663.
- 1969: The geographic distribution of recent and
fossil Ambositrinae (Hymenoptera: Proctotrup-
oidea: Diapriidae). *Tagungsberichte der Deutsche
Akademie der Landwirtschaften (Berlin)* 80 : 105-
109.

- McKeown, K. C. 1947: Catalogue of the Cerambycidae (Coleoptera) of Australia. *Memoirs of the Australian Museum (Sydney)* 10 : 331-341.
- 1963: Australian spiders (revised edition). Sirius books. Sydney, Angus & Robertson. 274 p.
- Meade-Waldo, G.; Morley, C.; Turner, R. E. 1915: Notes and synonymy of Hymenoptera in the collection of the British Museum, II. *Annals and magazine of natural history* 16 (8) : 331-341.
- Michener, C. D. 1944: Comparative external morphology, phylogeny, and a classification of the bees (Hymenoptera). *Bulletin of the American Museum of Natural History* 82 : 151-326.
- 1948: A character analysis of a solitary bee, *Hoplitis albifrons*. *Evolution* 1 : 172-185.
- 1953: Comparative morphological and systematic studies on bee larvae with a key to the families of hymenopterous larvae. *Kansas University science bulletin* 35 (8) : 897-1102.
- 1964: The possible use of uninomial nomenclature to increase the stability of names in biology. *Systematic zoology* 13 : 182-190.
- Miller, D. 1919: The economic bearing of hymenopterous insects. *New Zealand journal of agriculture* 19 : 201-208.
- 1955: Native insects. *Nature in New Zealand* series. Wellington, A. H. & A. W. Reed. 64 p.
- 1971 (and 1984): Common insects in New Zealand. Wellington, A. H. & A. W. Reed. 178 p. 1984 edition revised by A. K. Walker.
- Ogloblin, A. A. 1960: Una especie nueva del género *Austroserphus* Dodd (Proctotrupidae, Hymenoptera). *Actas y Trabajos del Primer Congreso Sudamericano de Zoología, La Plata, 1959, sección IV - Entomología* : 117-123.
- Olberg, G. 1959: Das Verhalten der solitären Wespen Mitteleuropas (Vespidae, Pompilidae, Sphecidae). Berlin, Deutscher Verlag der Wissenschaften. 401 p.
- Panzer, G. W. F. 1806: Kritische Revision der Insektenfauna Deutschlands nach dem System bearbeitet. Nuremberg. 271 p.
- Peck, O. 1937: The male genitalia in the Hymenoptera (Insecta); especially in the family Ichneumonidae. *Canadian journal of research (Ottawa) (D)* 15 : 221-274.
- Plath, O. E. 1934: Bumblebees and their ways. New York, Macmillan Co. 201 p.
- Pollard, S. E. 1982: *Epipompilus insularis* (Hymenoptera: Pompilidae), a parasitoid of hunting spiders. *New Zealand journal of zoology* 9 (1) : 37-39.
- Priesner, H. 1966: Zur Kenntnis der Gattung *Episyron* (Hymenoptera, Pompilidae). *Bollettino dell'Istituto di Entomologia della Università degli Studi di Bologna* 28 : 29-55.
- Quail, A. 1902: A fly and a spider (Pompilidae, *Salius monachus* Sm. and *Porrhothele antipodiana*). *Transactions and proceedings of the New Zealand Institute* 35 : 256-258.
- Richards, O. W. 1956 (and 1977): Hymenoptera: introduction and keys to families. *Handbooks for the identification of British insects* 4 (1). London, Royal Entomological Society. 94 p. (2nd edition, 100 p).
- Richards, O. W.; Hamm, A. H. 1939: The biology of the British Pompilidae. *Transactions of the Society for British Entomology* 6 (4) : 51-114.
- Riek, E. F. 1970: Hymenoptera. Pp. 867-959 in: The insects of Australia. CSIRO and Melbourne University Press.
- Riegel, G. T. 1949: The wings of the Braconidae (Hymenoptera). *Annals of the Entomological Society of America (Columbus)* 41 : 439-449.
- Ross, H. H. 1936: The ancestry and wing venation of the Hymenoptera. *Annals of the Entomological Society of America (Columbus)* 29 : 99-111.
- Röhwer, S. A.; Gahan, A. B. 1916: Horismology of the hymenopterous wing. *Proceedings of the Entomological Society of Washington* 18 : 20-76.
- Salman, K. A. 1929: The external morphology of *Pepsis elegans* Lepeletier (Hymenoptera: Psammocharidae). *Transactions of the American Entomological Society (Philadelphia)* 55 : 119-153.
- Schiödt, G. 1837: Samenstillung af Danmarks Pompilidae. *Kröyers naturhistorisk Tidsskrift. I.* 313 p.
- Schrank, F. von P. 1798: Fauna Boica, vol. 1. Nuremberg, Ingolstadt, Landshut. 720 p.
- Scobiola, X. 1963: Sur quelques Pompiloides, nouveaux ou rares, de la R.P. Roumaine: 11^e note. *Travaux du Museum d'Histoire Naturelle 'Grigore Antipa' (Bucharest)* 4 : 269-281.
- Scopoli, J. A. 1763: Entomologia Carniolica. Vienna. 421 p.
- Sharell, R. 1971: New Zealand insects and their story. Auckland and London, Collins. 268 p. (Revised 1982.)
- Short, J. R. T. 1952: The morphology of the head of larval Hymenoptera with special reference to the head of the Ichneumonidae, including a classification of the final-instar larvae of the Braconidae. *Transactions of the Royal Entomological Society of London* 103 (2) : 27-84.
- 1953: A grouping by larval characters of some species of the genus *Apanteles* (Hymenoptera: Braconidae). *Bulletin of entomological research* 44 : 327-332.
- Sielfeld, W. H. 1973: *Haploneurion obscurum* n. sp. *Anales del Museo de Historia Natural* 6 : 213-216.
- Simmonds, H. W. 1964: My weapons had wings. Privately published by the Fiji Society. 164 p.
- Smith, E. L. 1970: Hymenoptera. Pp. 156-170 in: Tuxen, S. L. (ed.), Taxonomist's glossary of genitalia in insects. Copenhagen, Munksgaard. 284 p.

- Smith, F. 1855: Catalogue of hymenopterous insects in the collection of the British Museum, London, printed by order of the trustees. Part 3: Mutillidae and Pompilidae. 206 p.
- 1876: Descriptions of new species of hymenopterous insects of New Zealand collected by C. M. Wakefield, Esq., principally in the neighbourhood of Canterbury. *Transactions of the Royal Entomological Society of London* : 473-487.
- 1878: Descriptions of new species of hymenopterous insects from New Zealand collected by Prof. Hutton, at Otago. *Transactions of the Royal Entomological Society of London* : 1-7.
- Snodgrass, R. E. 1941: The male genitalia of Hymenoptera. *Smithsonian miscellaneous collections* 99 (14). 86 p.
- Spinola, M. 1851: Himenopteros. Pp. 153-569 in: Gay, C., *Historia fisica y politica de Chile, zoologia*, vol. 6. Paris, Maulde & Renon. 572 p.
- Spooner, G. M. 1948: The British species of psenine wasps (Hymenoptera: Sphecidae). *Transactions of the Royal Entomological Society of London* 99 : 129-172.
- Tillyard, R. J. 1926: The insects of Australia and New Zealand. Sydney, Angus & Robertson. 560 p.
- 1935: The evolution of the scorpion-flies and their derivatives (Order Mecoptera). *Annals of the Entomological Society of America (Columbus)* 28 : 1-45.
- Townes, H. 1957: Nearctic wasps of the subfamilies Pepsinae and Ceropalinae. *Bulletin of the United States National Museum* 209. 286 p.
- 1972: A light-weight malaise trap. *Entomological news* 83 : 239-247.
- Townes, M.; Gupta, V. K. 1961: A catalogue and reclassification of the Indo-Australian Ichneumonidae. *Memoirs of the American Entomological Institute no. 1*. 522 p.
- Tsuneki, K. 1957: Ethological studies on *Bembix niponica* Smith, with emphasis on the psychobiological analysis of behaviour inside the nest. II. Experimental part. *Memoirs of the Faculty of Liberal Arts, Fukui University, series II, natural science* 7 : 1-116.
- Turner, R. E. 1914: New fossorial Hymenoptera from Australia and Tasmania. *Proceedings of the Linnean Society of New South Wales (Sydney)* 38 : 608-623.
- 1915: Descriptions of new fossorial wasps from Australia. *Proceedings of the Zoological Society of London, 1915* : 41-69.
- Valentine, E. W. 1967: A list of the hosts of entomophagous insects of New Zealand. *New Zealand journal of science* 10 (4) : 1100-1209.
- 1974: Wasps (I). *New Zealand's nature heritage* 3 (44) : 1230-1236.
- Van Emden, F. I. 1942: The collection and study of beetle larvae. *Entomologist's monthly magazine* 78 : 73-79.
- Walker, A. K. 1984: Common insects. 2: Insects of the bush and fresh water. *Mobil New Zealand nature series*. Wellington, A. H. & A. W. Reed. 79 p.
- Waterhouse, C. O. (ed.) 1883: Aid to the identification of insects. London, Fisher.
- Waterhouse, D. F. (ed.) 1970: The insects of Australia. CSIRO and Melbourne University Press. 1029 p.
- Watt, J. C. 1979: Abbreviations for entomological collections. *New Zealand journal of zoology* 6 : 519-520.
- Westwood, J. O. 1840: Synopsis of the genera of British insects. London. 158 p.
- Wheeler, W. M. 1923: Social life among the insects. New York, Harcourt Brace. 375 p.
- 1928: The social insects: their origin and evolution. New York, Harcourt Brace. 378 p.
- White, A.; Doubleday, E. 1843: List of the annulose animals hitherto recorded as found in New Zealand, with descriptions of some new species. Pp. 265-295 in: Dieffenbach, E., *Travels in New Zealand, with contributions to the geography, geology, botany and natural history of that country*, vol. 2. London, John Murray.
- Williams, F. X. 1919: Philippine wasp studies. Part ii, Descriptions of new species and life history studies. *Bulletin of the Hawaiian Sugar Planters' Experimental Station, entomological series* 14 : 19-186.
- 1945: The aculeate wasps of New Caledonia, with natural history notes. *Proceedings of the Hawaiian Entomological Society* 12 (2) : 407-452.
- 1947: Aculeate wasps of Fiji. *Occasional papers of the Bernice P. Bishop Museum (Honolulu)* 18 (21) : 317-336.
- Wilson, E. O. 1971: The insect societies. Cambridge (Mass.), The Belknap Press of Harvard University Press. 548 p.
- Wolf, H. 1960: Bemerkungen zu einigen Wegwespenarten (Hymenoptera: Pompilidae) (2). *Mitteilungen der Deutschen Entomologischen Gesellschaft* 19 : 49-56.
- Zimmermann, E. C. 1948: Insects of Hawaii: vol. 1, Introduction. Honolulu, University of Hawaii Press. 206 p.
- 1957: Insects of Hawaii: vol. 6, Ephemeroptera - Neuroptera - Trichoptera and supplement to vols 1-5. Honolulu, University of Hawaii Press. 209 p.

APPENDIX 1: TABLES

Key to abbreviations used

max p4 w/l	maxillary palp segment 4 width ÷ length
ant3/max p4	antennal segment 3 length ÷ maxillary palp segment 4 length
cly/max p6	median length of clypeus ÷ maxillary palp segment 6 length
cly h/w	clypeus height ÷ width
ant2/ms	antennal segment 2 length ÷ malar space
scape w/l	scape width ÷ length
ant3 w/l	antennal segment 3 width ÷ length
UID/ant3	upper interocular distance ÷ antennal segment 3 length
FD/TFD	facial distance ÷ transfacial distance
TFD/MID	transfacial distance ÷ median interocular distance
LID/UID	lower interocular distance ÷ upper interocular distance
POL:OOL	postocellar line ÷ ocellar-ocular line
fofem w/l	fore femur width ÷ length
mc/s	marginal cell length ÷ stigma length
mc/dwa	medial cell length ÷ distance from wing apex
smc2/3	submarginal cell 2 length ÷ cell 3 length

Sample size and provenance

The following examples of each species were measured:

Priocnemis monachus: 16 females from ND, TO, WN, NN, BR, MC, DN, SI; 6 males from ND, WN, NN, WD, SI.

P. conformis: 11 females from ND, WN, MC, SC, CO; 10 males from ND, WN, NN, MC, CO, DN, SI.

P. nitidiventris: 22 females from AK, TO, TI, WI, WN, NN, WD, NC, MC, SC, OL, CO, DN, FD, SI; 9 males from ND, TO, WN, NN, WD, DN, SI.

P. ordishi: 7 females from ND, TO, WN, NN, MC, CO; 4 males from TO, WN, CO, DN.

P. carbonarius: 7 females from ND, TI, WN, KA, MC, CO; 6 males from WN, NN, WD, CO, DN.

P. crawi: 7 females from WN, NN, WD, DN, FD, SI; 6 males from WN, NN, WD, CO, DN, SI.

Sphictostethus nitidus: 15 females from ND, AK, TO, GB, WI, WN, NN, MC, WD, OL, CO; 10 males from ND, WI, WN, NN, MB, MC, DN.

S. calvus: 11 females from HB, WN, NN, BR, WD, NC, SC, DN, SI; 11 males from ND, TO, WN, NN, MB, MC, SC, DN.

S. fugax: 31 females from ND, AK, WN, NN, NC, SC, DN, FD, SI; 6 males from WN, DN.

Epipompilus insularis: 9 females from ND, WN, NN, WD, SC, SI; 5 males from AK, TI, MC, SC.

Table 1 Length ratios of maxillary palp segments 3–6 and antennal segments 1–4 in New Zealand Pompilidae, from widely differing examples of each sex (population area codes in parentheses).

	Segment no:	Maxillary palp ratio				Antennal ratio			
		3	4	5	6	1	2	3	4
<i>Priocnemis monachus</i>	(ND) ♀	0.89	: 1.08	: 1.00	: 1	0.90	: 0.32	: 1.16	: 1
	(BR) ♀	1.00	: 1.20	: 1.05	: 1	0.81	: 0.35	: 1.08	: 1
	(ND) ♂	0.91	: 1.12	: 0.97	: 1	1.23	: 0.37	: 0.98	: 1
	(SI) ♂	1.01	: 1.24	: 1.08	: 1	0.95	: 0.38	: 0.97	: 1
<i>conformis</i>	(SC) ♀	1.00	: 1.36	: 1.18	: 1	0.88	: 0.31	: 1.03	: 1
	(SC) ♀	0.91	: 1.27	: 1.12	: 1	0.83	: 0.42	: 1.11	: 1
	(WN) ♂	0.81	: 1.15	: 0.97	: 1	0.93	: 0.44	: 0.89	: 1
	(DN) ♂	0.92	: 1.26	: 1.14	: 1	0.97	: 0.42	: 1.01	: 1
<i>nitidiventris</i>	(AK) ♀	0.81	: 1.03	: 1.00	: 1	0.84	: 0.36	: 1.14	: 1
	(SC) ♀	0.92	: 1.10	: 1.00	: 1	0.83	: 0.34	: 1.11	: 1
	(ND) ♂	0.78	: 1.10	: 0.99	: 1	0.85	: 0.41	: 0.98	: 1
	(ND) ♂	0.89	: 1.11	: 1.05	: 1	0.84	: 0.41	: 0.95	: 1
<i>ordishi</i>	(WN) ♀	0.91	: 1.15	: 1.01	: 1	0.96	: 0.39	: 1.03	: 1
	(CO) ♀	0.91	: 1.19	: 1.03	: 1	0.91	: 0.32	: 1.12	: 1
	(WN) ♂	0.88	: 1.09	: 1.03	: 1	0.90	: 0.48	: 0.86	: 1
	(DN) ♂	0.90	: 1.07	: 0.91	: 1	0.94	: 0.53	: 0.94	: 1
<i>carbonarius</i>	(ND) ♀	1.05	: 1.28	: 1.03	: 1	1.01	: 0.35	: 0.98	: 1
	(DN) ♀	0.93	: 1.04	: 0.95	: 1	0.89	: 0.43	: 1.00	: 1
	(WN) ♂	1.03	: 1.25	: 1.02	: 1	0.84	: 0.47	: 0.89	: 1
<i>crawi</i>	(WN) ♀	0.84	: 1.11	: 0.98	: 1	0.92	: 0.41	: 1.00	: 1
	(CO) ♀	0.90	: 1.09	: 0.95	: 1	1.00	: 0.47	: 0.97	: 1
	(WN) ♂	0.67	: 1.06	: 0.92	: 1	0.92	: 0.48	: 0.88	: 1
<i>Sphictostethus nitidus</i>	(ND) ♀	1.12	: 1.29	: 1.00	: 1	0.94	: 0.34	: 1.22	: 1
	(GB) ♀	1.16	: 1.27	: 0.96	: 1	1.14	: 0.44	: 1.21	: 1
	(NN) ♀	1.28	: 1.43	: 1.16	: 1	1.00	: 0.42	: 1.22	: 1
	(ND) ♂	0.85	: 1.06	: 0.84	: 1	0.81	: 0.37	: 0.91	: 1
	(WI) ♂	0.97	: 1.11	: 0.90	: 1	0.83	: 0.41	: 0.92	: 1
	(NN) ♂	1.07	: 1.38	: 1.09	: 1	0.82	: 0.45	: 0.87	: 1
<i>calvus</i>	(WN) ♀	1.16	: 1.36	: 1.00	: 1	0.80	: 0.39	: 1.08	: 1
	(DN) ♀	1.10	: 1.28	: 0.94	: 1	0.90	: 0.43	: 1.16	: 1
	(ND) ♂	1.05	: 1.27	: 1.01	: 1	0.79	: 0.43	: 0.87	: 1
	(DN) ♂	1.02	: 1.41	: 1.10	: 1	0.79	: 0.40	: 0.87	: 1
<i>fugax</i>	(ND) ♀	1.19	: 1.36	: 0.93	: 1	0.70	: 0.29	: 1.03	: 1
	(DN) ♀	1.25	: 1.37	: 1.08	: 1	0.67	: 0.31	: 1.11	: 1
	(WN) ♂	1.04	: 1.34	: 0.88	: 1	0.73	: 0.38	: 0.85	: 1
	(DN) ♂	1.07	: 1.20	: 0.91	: 1	0.79	: 0.40	: 0.90	: 1
<i>Epipompilus insularis</i>	(ND) ♀	0.72	: 1.05	: 0.80	: 1	1.06	: 0.41	: 0.78	: 1
	(SC) ♀	0.95	: 1.27	: 1.01	: 1	1.04	: 0.42	: 0.73	: 1
	(TK) ♂	0.78	: 1.14	: 0.95	: 1	0.83	: 0.53	: 0.86	: 1
	(SC) ♂	0.66	: 1.00	: 0.82	: 1	0.95	: 0.50	: 0.91	: 1

Table 2 Morphometrics for *Priocnemis (Trichocurgus) monachus*, *P. conformis*, *P. nitidiventris*, *P. ordishi*, *P. carbonarius*, *P. crawi*, and *Epipompilus insularis* (in parentheses, data for Central Otago populations).

Measurement	Mean		Range		Mean		Range		Mean		Range		Mean		Range	
	<i>monachus</i>		<i>conformis</i>		<i>nitidiventris</i>		<i>ordishi</i>		<i>carbonarius</i>		<i>crawi</i>					
Females																
max p4 w/l	5.81	5.20–6.65	5.92	5.29–7.48	4.52	3.97–5.50	5.15	4.67–6.10	5.33	4.70–6.00	4.99	4.36–5.83				
ant3/max p4	0.63	0.56–0.72	0.77	0.67–0.96	0.53	0.46–0.64	0.67	0.60–0.78	0.64	0.62–0.69	0.72	0.69–0.75				
cly/max p6	1.01	0.90–1.15	1.03	0.88–1.22	0.79	0.68–0.89	0.86	0.80–1.06	0.88	0.79–0.97	0.98	0.95–1.05				
cly h/w	3.17	2.41–3.55	3.85	2.87–4.19	2.67	2.50–2.86	2.64	2.33–2.84	2.78	2.53–3.03	3.04	2.89–3.22				
ant2/ms	0.34	0.24–0.41	0.20	0.16–0.25	0.31	0.26–0.39	0.30	0.18–0.40	0.06	0.03–0.10	0.19	0.15–0.22				
										(0.06–0.20)		(0.08–0.21)				
scape w/l	1.98	1.45–2.18	1.85	1.86–2.08	1.90	1.77–2.15	2.03	1.85–2.21	1.89	1.77–2.00	1.95	1.75–2.07				
ant3 w/l	3.83	3.29–4.23	2.89	1.56–3.65	4.06	3.13–4.41	3.45	4.05–2.89	3.61	3.37–4.00	3.24	2.90–3.54				
UID/ant3	0.76	0.67–0.92	0.61	0.41–0.79	0.81	0.67–0.90	0.71	0.62–0.81	0.72	0.64–0.78	0.57	0.48–0.62				
FD/TFD	1.26	1.18–1.37	1.27	1.18–1.34	1.19	1.12–1.26	1.22	1.17–1.27	1.21	1.19–1.23	1.22	1.19–1.25				
TFD/MID	0.60	0.55–0.77	0.61	0.58–0.63	0.56	0.50–0.69	0.55	0.53–0.58	0.53	0.52–0.54	0.56	0.52–0.58				
LID/UID	0.82	0.63–0.97	0.85	0.80–0.99	0.78	0.65–0.86	0.78	0.74–0.81	0.82	0.81–0.84	0.86	0.80–0.89				
POL:OOL	0.46	0.40–0.53	0.61	0.47–0.69	0.72	0.50–0.85	0.60	0.44–0.80	0.66	0.53–0.77	0.40	0.38–0.42				
fofem w/l	4.23	3.70–6.49	3.59	3.39–3.86	4.13	0.78–4.50	3.82	3.52–4.35	3.68	3.20–3.93	3.36	3.10–3.58				
mc/s	0.42	0.38–0.46	0.48	0.43–0.53	0.47	0.38–0.52	0.42	0.38–0.51	0.52	0.50–0.58	0.51	0.47–0.55				
mc/dwa	0.62	0.53–0.65	0.76	0.61–0.91	0.57	0.52–0.61	0.65	0.55–0.81	0.90	0.79–1.00	0.90	0.84–1.08				
smc2/3	1.34	1.25–1.45	1.30	1.20–1.54	1.02	0.92–1.11	0.94	0.82–1.09	0.83	0.72–0.89	0.97	0.80–1.04				
Males																
										<i>insularis</i> , ♀		<i>insularis</i> , ♂				
max p4 w/l	5.50	5.00–5.83	6.75	6.82–7.44	4.33	3.90–4.89	4.60	3.84–5.56	4.86	4.30–5.51	5.40	4.96–5.79				
ant3/max p4	0.79	0.65–0.95	1.01	0.96–1.07	0.74	0.64–0.83	0.89	0.84–0.93	0.99	0.92–1.11	1.00	0.92–1.16				
cly/max p6	1.03	0.79–1.17	1.22	1.17–1.29	1.02	0.89–1.14	1.09	1.26–0.98	0.98	0.80–1.14	0.96	0.85–1.04				
cly h/w	2.83	2.61–2.90	2.82	2.73–2.92	2.82	2.53–3.03	2.81	2.50–3.29	2.68	2.47–3.01	2.34	2.13–2.48				
ant2/ms	0.25	0.22–0.27	0.13	0.08–0.21	0.29	0.21–0.33	0.24	0.18–0.30	0.58	0.50–0.70	0.55	0.39–0.69				
scape w/l	2.02	1.78–2.16	1.84	1.16–2.21	1.76	1.52–1.91	1.86	1.56–2.06	1.63	1.50–1.90	1.45	1.35–1.50				
ant3 w/l	2.93	2.67–3.14	2.56	1.82–2.80	2.76	2.50–2.96	2.45	2.08–2.87	1.79	1.42–2.11	1.60	1.51–1.69				
UID/ant3	0.58	0.50–0.68	0.50	0.44–0.54	0.57	0.50–0.62	0.53	0.46–0.63	0.42	0.36–0.47	0.40	0.33–0.46				
FD/TFD	1.25	1.21–1.28	1.22	1.17–1.26	1.17	1.08–1.23	1.17	1.13–1.21	1.24	1.17–1.31	1.18	1.13–1.23				
TFD/MID	0.60	0.59–0.60	0.60	0.57–0.63	0.57	0.54–0.59	0.57	0.57–0.58	0.65	0.63–0.67	0.61	0.60–0.63				
LID/UID	0.93	0.89–0.98	0.97	0.92–1.01	0.91	0.83–0.95	0.89	0.80–0.97	0.81	0.77–0.85	0.95	0.90–1.04				
POL:OOL	0.49	0.45–0.53	0.54	0.49–0.60	0.75	0.62–0.86	0.56	0.52–0.59	1.42	1.20–1.54	1.63	1.38–2.00				
fofem w/l	3.65	3.37–3.89	3.63	3.46–3.91	3.41	3.03–3.68	3.22	2.85–3.57	2.47	2.27–2.62	2.63	2.42–3.11				
mc/s	0.43	0.42–0.46	0.55	0.51–0.61	0.50	0.43–0.56	0.42	0.32–0.46	0.66	0.62–0.69	0.80	0.75–0.96				
mc/dwa	0.53	0.46–0.56	0.70	0.61–0.75	0.54	0.50–0.65	0.73	0.61–0.99	0.67	0.59–0.76	0.55	0.52–0.60				
smc2/3	1.31	1.17–1.40	1.15	1.10–1.20	0.93	0.76–1.08	0.90	0.75–1.02	1.08	0.96–1.40	1.01	0.95–1.09				

Table 3 Morphometrics for *Sphictostethus nitidus*, *S. calvus*, and *S. fugax* (WN-AK denotes southern and central North Island; ND denotes Spirits Bay population, Northland).

Measurement	Mean	Range	Mean	Range	Mean	Mean	Range	Mean	Range
	South Island		North I. (WN-AK)		ND	<i>calvus</i>		<i>fugax</i>	
Females									
max p4 w/l	6.95	6.41–7.42	6.70	6.15–7.04	8.46	7.20	6.21–7.72	8.18	7.00–9.39
ant3/max p4	0.75	0.70–0.82	0.75	0.73–0.78	0.73	1.02	0.91–1.09	0.75	0.70–0.84
cly/max p6	1.10	0.99–1.20	1.02	0.97–1.09	1.19	1.21	1.14–1.43	0.94	0.84–1.38
cly h/w	3.32	3.17–3.52	3.10	2.85–3.17	3.38	3.10	2.69–3.47	2.49	2.13–2.74
ant2/ms	0.20	0.17–0.27	0.13	0.10–0.16	0.09	0.34	0.29–0.38	0.11	0.03–0.21
scape w/l	2.14	1.98–2.31	1.94	1.23–2.27	2.15	1.67	1.59–1.80	1.79	1.67–1.90
ant3 w/l	3.71	3.47–3.91	3.65	3.36–4.13	4.14	2.54	2.36–2.74	4.52	4.30–5.01
UID/ant3	0.75	0.70–0.83	0.74	0.70–0.81	0.85	0.53	0.49–0.57	0.84	0.73–1.00
FD/TFD	1.24	1.15–1.29	1.21	1.15–1.26	1.23	1.22	1.16–1.26	1.19	1.12–1.25
TFD/MID	0.62	0.60–0.66	0.58	0.56–0.60	0.57	0.58	0.57–0.60	0.56	0.54–0.59
LID/UID	0.79	0.74–0.85	0.79	0.71–0.80	0.79	0.93	0.90–0.96	0.81	0.76–0.86
POL:OOL	0.48	0.42–0.54	0.49	0.42–0.56	0.43	0.55	0.45–0.64	0.61	0.45–0.77
fofem w/l	3.90	3.56–4.17	3.90	3.79–3.98	4.29	3.32	2.89–3.63	3.82	3.55–3.77
mc/s	0.42	0.40–0.44	0.46	0.49–0.52	0.47	0.54	0.52–0.57	0.47	0.42–0.53
mc/dwa	0.47	0.43–0.51	0.50	0.49–0.54	0.45	0.37	0.36–0.40	0.39	0.36–0.44
smc2/3	1.56	1.44–1.76	1.45	1.35–1.51	1.46	1.52	1.44–1.63	1.48	1.44–1.59
Males									
max p4 w/l	7.55	6.45–8.51	6.76	5.69–7.24		7.20	6.21–7.72	7.85	7.60–8.07
ant3/max p4	1.04	0.94–1.15	0.90	0.81–1.00		1.02	0.91–1.09	1.08	1.05–1.13
cly/max p6	1.26	1.21–1.30	1.01	0.73–1.25		1.21	1.14–1.43	1.28	1.10–1.48
cly h/w	2.75	2.56–2.93	2.24	1.61–2.78		3.10	2.69–3.47	0.85	2.58–3.00
ant2/ms	0.16	0.13–0.19	0.17	0.13–0.26		0.34	0.29–0.38	0.12	0.10–0.13
scape w/l	1.94	1.80–2.08	2.09	2.02–2.13		1.67	1.59–1.80	1.69	1.58–1.77
ant3 w/l	3.02	2.75–3.33	3.14	2.89–3.54		2.54	2.36–2.74	2.80	2.42–3.21
UID/ant3	0.57	0.53–0.68	0.59	0.54–0.63		0.53	0.49–0.57	0.56	0.50–0.61
FD/TFD	1.22	1.18–1.27	1.20	1.17–1.22		1.22	1.16–1.26	1.22	1.18–1.24
TFD/MID	0.60	0.58–0.61	0.58	0.57–0.60		0.58	0.57–0.60	0.60	0.59–0.61
LID/UID	0.93	0.82–0.97	0.95	0.92–1.00		0.93	0.90–0.96	0.93	0.90–0.96
POL:OOL	0.52	0.37–0.66	0.53	0.43–0.54		0.55	0.45–0.64	0.61	0.55–0.64
fofem w/l	3.65	3.50–3.80	3.68	3.46–4.00		3.32	2.89–3.63	3.46	3.21–3.89
mc/s	0.48	0.46–0.49	0.49	0.47–0.52		0.54	0.52–0.57	0.52	0.47–0.54
mc/dwa	0.43	0.39–0.48	0.44	0.39–0.51		0.37	0.36–0.40	0.37	0.34–0.43
smc2/3	1.42	1.36–1.47	1.36	1.21–1.51		1.52	1.44–1.63	1.48	1.29–1.70

APPENDIX 2: HOST RECORDS FOR POMPILIDAE IN NEW ZEALAND

Unless otherwise stated, records are my own. Determination of host spiders was by Dr R. R. Forster. Paralysed spiders were taken for identification from female wasps in the field; for hosts of *Epipompilus insularis*, however, spiders parasitised in the field were taken to the laboratory and the parasite was later determined from its larvae or pupae. Many parasitised spiders were taken from nests of pompilid species occurring in New Zealand.

Cryptocheilus australis

Family PISAURIDAE

Dolomedes minor Koch: 139 mature females — Spirits Bay, North Cape, Te Hapua, Waipoua, Dargaville (ND); Henderson, Auckland (AK).

Dolomedes aquaticus Goyen: 26 mature females — Spirits Bay, North Cape, Te Hapua, Waipoua (ND).

Dolomedes 'sp. A': 36 mature females — Spirits Bay, North Cape, Waipoua (ND).

Dolomedes 'sp. B': 22 immature females — Spirits Bay, North Cape, Waipoua (ND).

Priocnemis (T.) monachus

Family DIPLURIDAE

Porrhothele antipodiana Walckenaer: 208 large females — Mt Taranaki (TK); Ruahine Range (RI); Tararua Range, Karori, Kelburn, Wainuiomata (WN); Lake Daniells (BR); Leith Saddle, Trotters Gorge (DN).

Family CTENIZIDAE

Cantuaria huttoni (Cambridge): 32 females — Trotters Gorge, Waianakarua, Mt Misery (DN).

Cantuaria allani Forster: 27 mature females — Stewart Island (SI).

Cantuaria stewarti (Todd): 22 mature females — Stewart Island (SI).

Cantuaria sp.: 4 females — Stewart Island (SI).

Family STIPHIDIIDAE

Cambridgea foliata (Koch): 11 mature females — Mt Holdsworth track, Orongorongo Valley (WN).

Family PISAURIDAE

Dolomedes minor Koch: 3 mature females — Waipoua (ND).

Family MITURGIDAE

Miturga 'sp. A': 8 mature females — Akatarawa Saddle, Otaki Forks, Orongorongo Valley (WN).

OTHER OBSERVATIONS. Quail (1902) recorded *Porrhothele antipodiana* as a prey species for *P. monachus*, but described and illustrated a nest of *Pison spinolae* which he considered to be the work of *P. monachus*. Simmonds (1964) made the extraordinary statement (about the fauna of Mt Arthur Tableland, NN): "Along the path a large blue-black pompilid wasp and a crimson and gold one hunted their prey. In my notes I recorded the former as carrying off tiger beetles". Laing (1978, 1979) reported the supposed effects of *P. monachus* predation on *Porrhothele*

antipodiana populations.

Priocnemis (T.) conformis

Family DIPLURIDAE

Porrhothele antipodiana (Walckenaer): 55 very immature examples — Mt Taranaki, Merimeri (TK); Mt Holdsworth track, Akatarawa Saddle, Renata (all Tararua Range, WN); L. Christabel, L. Daniells (BR).

Family CTENIZIDAE

Cantuaria huttoni (Pickard-Cambridge): 120 mature females — Piano Flat (CO); Dunedin Town Belt, Warrington, Taieri Mouth (DN).

Cantuaria allani Forster: 49 immature females — Half Moon Bay, Lee Bay, Big Bungaree Bay, Maori Beach, Christmas Village, Port Pegasus (SI).

Priocnemis (T.) nitidiventris

Family LYCOSIDAE

Lycosa 'sp. A', "Coastal sand lycosid": 261 immature females — Spirits Bay, Ahipara Bay, Whangarei (ND); Kaipara Harbour mouth (AK); Gisborne (GB); New Plymouth (TK); Castlecliff (WI); Paekakariki (WN); Kaikoura (KA); Sumner (MC); Haast foreshore (WD); Tahuna Beach (DN); Tautuku Beach, Ocean Beach (SL); Lee Bay, Maori Beach (SI).

Lycosa hilaris Koch: 6 mature and 21 immature females — Trotter's Gorge (DN); Whitcombe Creek, Piano Flat (CO).

Lycosa 'sp. B': 3 immature females — Bealey R., Arthur's Pass (NC).

Lycosa 'sp. C': 4 mature females — Orongorongo R. bed (WN).

Lycosa 'sp. D': 1 mature female — Linden (WN).

Family CLUBIONIDAE

Clubiona peculiaris Koch: 16 mature females — Kaikoura (KA); Timaru (SC); Taieri Mouth (DN).

Clubiona huttoni Forster: 12 mature females — St Kilda, Warrington, Taieri Mouth (DN); 17 immature females — Moeraki, Warrington, Taieri Mouth (DN).

Family GNAPHOSIDAE

Hypodrossodes mauricus Dalmas: 11 mature females — Spirits Bay, Ahipara Bay (ND); New Plymouth (TK); Paekakariki (WN); 13 immature females — Spirits Bay, Ahipara Bay (ND); New Plymouth (TK).

Family THERIDIIDAE

Achaearanea 'sp. A': 10 immature females — Rangitata R., Peel Forest (MC); Otaiho R. (SC).

Family GRADUNGULIDAE

Gradungula sorenseni Forster: 5 immature females — Haast foreshore (WD).

Family SALTICIDAE

Trite auricoma (Urquhart): 2 mature females — New Brighton beach (MC).

Priocnemis (T.) ordishi

Family LYCOSIDAE

Lycosa hilaris Koch: 48 immature females — Akatarawa

Saddle (WN); Kaikoura (KA); Peel Forest (SC); Flagstaff Hill (DN); Tautuku (SL); Oban (SI).

Family SALTICIDAE

Trite auricomma (Urquhart): 29 immature females — Akatarawa Saddle (WN); Kaikoura (KA); Peel Forest (SC); Flagstaff Hill (DN); Tautuku (SL).

Family CLUBIONIDAE

Clubiona peculiaris (Koch): 17 immature females — Akatarawa Saddle, Mt Holdsworth track (WN); Kaikoura (KA); Flagstaff Hill (DN); Tautuku (SL).

Clubiona huttoni Forster: 6 immature females — Flagstaff Hill (DN).

Priocnemis (T.) carbonarius

Family SALTICIDAE

Trite auricomma (Urquhart): 49 immature females — Akatarawa Saddle, Orongorongo Valley (WN); Kaikoura (KA); Dunedin (DN).

Family LYCOSIDAE

Lycosa hilaris Koch: 53 immature females — Karori (WN); Kaikoura (KA); Waianakarua Scenic Reserve, Trotter's Gorge (DN); Rock and Pillar Range (CO).

Lycosa 'sp. A': 21 immature females — Karori, Akatarawa Saddle, Orongorongo River valley (WN).

Lycosa 'sp. B': 1 mature female — Blenheim (MB).

Family GNAPHOSIDAE

Hypodrassodes maoricus Dalmas: 16 immature females — Mt Unuwhao (ND); Mt Holdsworth track (WN); Kaikoura (KA).

Family AGELENIDAE

Neoramia 'sp. A': 11 immature females — Obelisk Range, Garvie Mountains (CO).

Family CYCLOCTENIDAE

Toxopsiella centralis Forster: 9 immature females — Mt Holdsworth track, Akatarawa Saddle, Mt Matthews (WN).

Toxopsiella orientalis Forster: 8 immature females — Flagstaff Hill (DN); Balclutha, Tautuku (SL).

Priocnemis (T.) crawi

Family LYCOSIDAE

Lycosa hilaris Koch: 14 immature females — near Kapakapanui (WN); Rock and Pillar Range, Dansey's Pass summit (CO); Leith Saddle (DN).

Lycosa 'sp. A': 2 mature females — Akatarawa Saddle (WN).

Family CYCLOCTENIDAE

Toxopsiella minuta Forster: 7 mature females — Pleasant Flat, Haast River (WD).

Toxopsiella 'sp. A': 1 immature female — Makarora (OL).

Sphictostethus nitidus

Family DIPLURIDAE

Porrhothele antipodiana Walckenaer: 28 immature females — TK, WI, WN, BR, KA, MC, DN.

Family MITURGIDAE

Miturga 'sp. A': 36 mature females, 19 immature females — WN.

Miturga 'sp. B': 5 mature females, 14 immature females — WN, MC.

Family PISAURIDAE

Dolomedes minor Koch: 27 mature females, 39 immature females — ND, AK, WO, TK, WI, WA, WN, BR, MC, SC, DN.

Dolomedes aquaticus Doyen: 12 mature females, 21 immature females, 9 mature males — TK, WI, WN, BR, MC, DN.

Dolomedes 'sp. A': 2 mature males — NC.

Family STIPHIDIIDAE

Cambridgea foliata Koch: 2 mature females, 12 immature females — WN.

Cambridgea antipodiana (White): 2 mature females, 17 immature females — WN, BR, NC, MC, SC, DN.

Cambridgea arboricola (Urquhart): 9 immature females — TK, WI, WN, BR, MC, SC, DN.

Family AMPHINECTIDAE

Amphinecta decemmaculata Simon: 22 mature females — WN.

Amphinecta tula Forster: 11 mature females — TO.

Amphinecta 'sp. A': 4 immature females — MB, BR.

Family DESIDAE

Ixeuticus martius (Simon): 18 mature females — WN, BR, NC, MC, SC, DN.

Family AGELENIDAE

Neoramia otagoa Forster: 6 mature females, 8 immature females — DN.

Family LYCOSIDAE

Lycosa hilaris Koch: 2 mature females — DN.

Family NICODAMIDAE

Megadictyna thileniusi Dahl: 5 mature females — MB, BR.

Sphictostethus calvus

Family CLUBIONIDAE

Clubiona consensa Forster: 9 mature females, 10 immature females — Aiken's Siding, Otira, Port Jackson (WD); Arthur's Pass (NC); Tautuku (SL).

Clubiona huttoni Forster: 12 mature females, 2 immature females — Leith Saddle (DN); Tautuku (SL); Leigh Bay (SI).

Clubiona peculiaris Koch: 11 mature females — Eglinton Valley (FD).

Clubiona 'sp. A': mature female — Aiken's Siding (WD).

Family AGELENIDAE

Neoramia oroua Forster: 4 mature females, 2 immature females — Otaki Forks, Mt Kapakapanui (WN).

Neoramia mamoeba Forster: 4 mature females, 2 immature females — Mt Luxmore track, Te Anau (FD).

Neoramia 'sp. A': 1 immature male — Mt Kapakapanui (WN).

Family DESIDAE

Ixeuticus martius (Simon): 14 mature females, 17 immature females — Mt Holdsworth track (WN); Peel Forest (SC); Tautuku (SL).

Family MITURGIDAE

Miturga frenata Koch: 21 immature specimens — Kapakapanui, Renata hut, Wellington Botanic Gardens (WN).

Miturga parva Koch: 6 immature females — Otira (WD); Kelsey's Bush (WD).

Family NEOLANIDAE

Neolanus dalmasi (Marples): 33 mature females, 38 immature females — Mt Holdsworth track, Otaki Forks, Mitre Flat, Totara Flats, Akatarawa Saddle (WN).

Sphictostethus fugax

Family CLUBIONIDAE

Clubiona peculiaris Koch: 32 mature females — ND, WN, FD, SL, SI.

Clubiona consensa Forster: 28 mature females — ND, WI, WN, BR, FD, SL, SI.

Clubiona 'sp. A': 11 mature females — WD, SC.

Clubiona 'sp. B': 9 mature females — SC.

Family STIPHIDIIDAE

Cambridgea antipodiana (White): 27 immature females — BR, SC, DN, FD, SL, SI.

Cambridgea fasciata (Koch): 21 immature females — TK, WN.

Cambridgea arboricola (Urquhart): 5 immature females — BR, FD.

Family CYCLOCTENIDAE

Cycloctenus fugax (Bryant): 17 immature females — DN.

Cycloctenus 'sp. A': 2 immature females — SC.

Family AGELENIDAE

Neoramia otagoa Forster & Wilton: 16 immature females — DN.

Neoramia janus (Bryant): 16 immature females — SC.

Neoramia matua Forster & Wilton: 5 immature females — DN, SL.

Neoramia 'sp. A': 7 immature males — WN.

Family GNAPHOSIDAE

Hypodrossodes maoricus Dalmas: 5 immature females — WN.

Taieria erebus (Koch): 3 immature females — MC.

Family DESIDAE

Ixeuticus martius (Simon): 6 immature females — SC.

Ixeuticus dalmasi Marples: 16 immature females — WN.

NOTE. At Peel Forest (SC), where *S. fugax* is unusually abundant, immature *Cambridgea* females are the most commonly used hosts.

Epipompilus insularis

Family CLUBIONIDAE

Clubiona cambridgei Koch: 62 mature females — Wanganui (WI); Wellington (WN); Maitai, Nelson (NN); Christchurch (MC); Peel Forest (SC); Lee Bay (SI).

Clubiona contrita Forster: 19 mature females — Blenheim (MB); Arthur's Pass (NC); Christchurch (MC); Geraldine (SC); Dunedin (DN).

Clubiona cada Forster: 23 mature females — Mt Unuwhao, Kaitaia (ND); Wanganui (WI); Wellington (WN); Christchurch (MC); Dunedin (DN).

Clubiona consensa Forster: 12 mature females — Spirits Bay, Kaitaia, Whangarei (ND); Dunedin (DN).

Clubiona convoluta Forster: 18 mature females — Tauteku, Mt Pye (SL); Lee Bay, Christmas Village (SI).

Family SALTICIDAE

Trite auricoma (Urquhart): 67 mature females — throughout.

Trite planiceps (Simon): 42 mature females — throughout.

Family DESIDAE

Matachia livor (Urquhart): 48 mature females — Maitai, Nelson (NN); Kaikoura (KA); Christchurch (MC); Geraldine (SC); Oamaru (DN).

Notomatachia cantuaria Forster: 31 mature females — The Brook, Nelson (NN); Hagley Park, Christchurch (MC); Peel Forest, Geraldine (SC); Oamaru (DN); Dunedin (DN).

OTHER OBSERVATIONS. Pollard (1982) recorded eggs and larvae on *Clubiona cambridgei* Koch and *Salticus* sp. I have unconfirmed reports of many other species of host spider identified by me in the field.

ILLUSTRATIONS

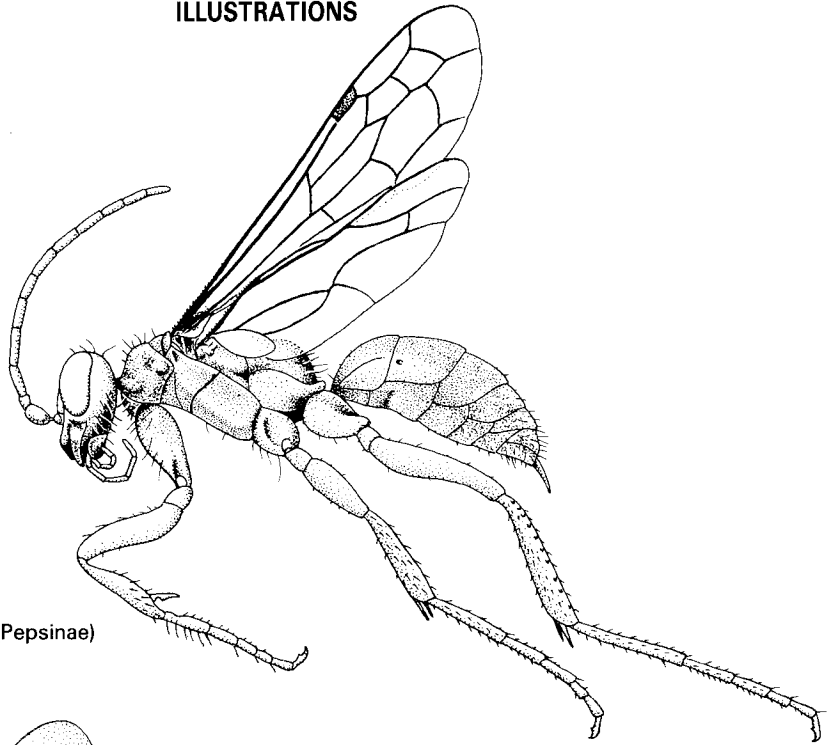

1. *Priocnemis nitidiventris*, ♀ (Pepsinae)

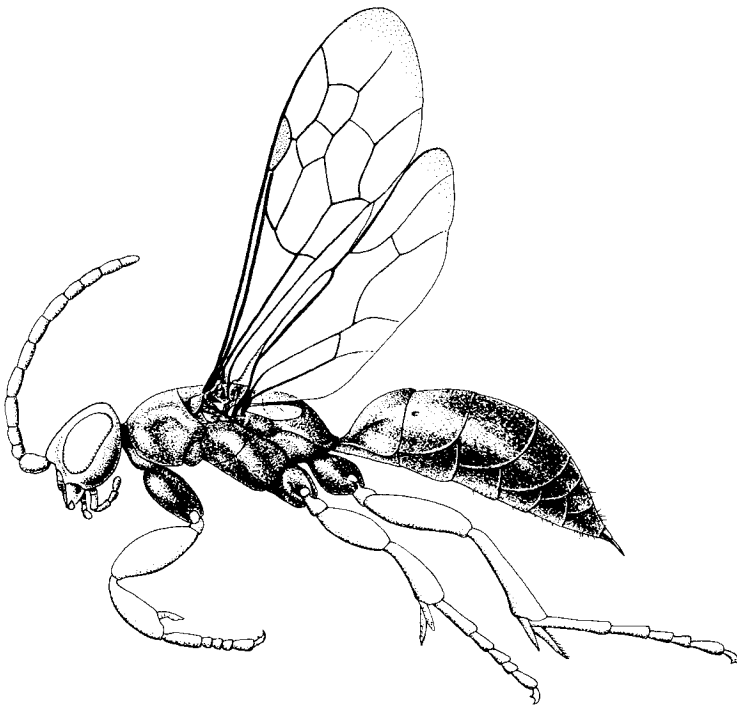

2. *Epipompilus insularis*, ♀ (Pompilinae)

Figures 1 and 2 Habitus drawings, in lateral view, of species representing the subfamilies of New Zealand Pompilidae.

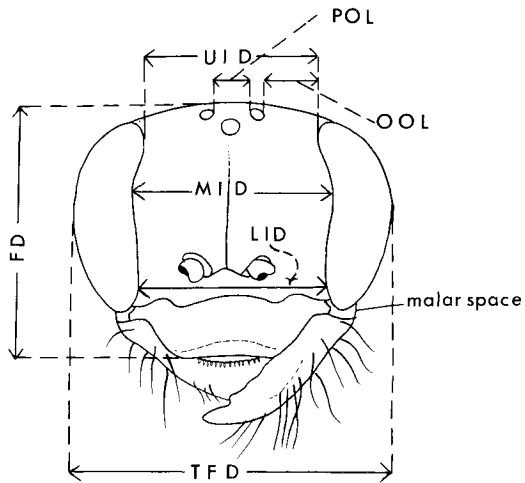

3. Head ratios (*P. conformis*, ♀)

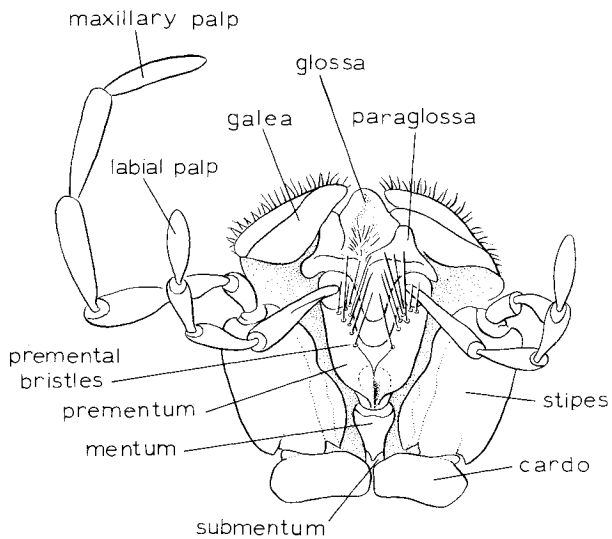

4. Labium and maxilla, ♀ (*P. carbonarius*)

Figures 3–12 Schematic diagrams of morphological features of New Zealand Pompilidae, illustrating terminology used.

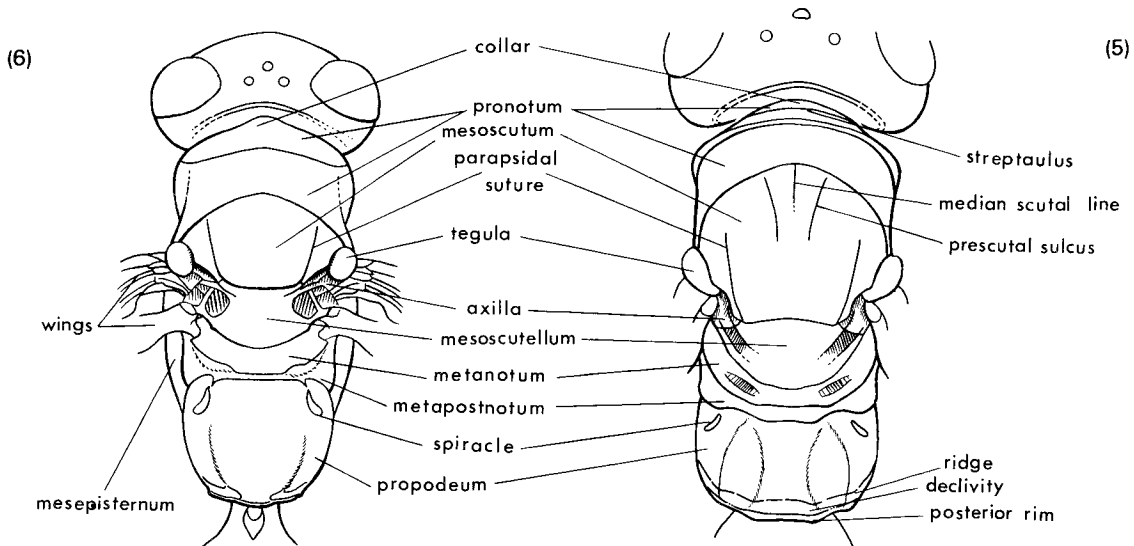

5, 6. Head and mesosoma, dorsal, ♀
(*P. conformis* and *E. insularis*)

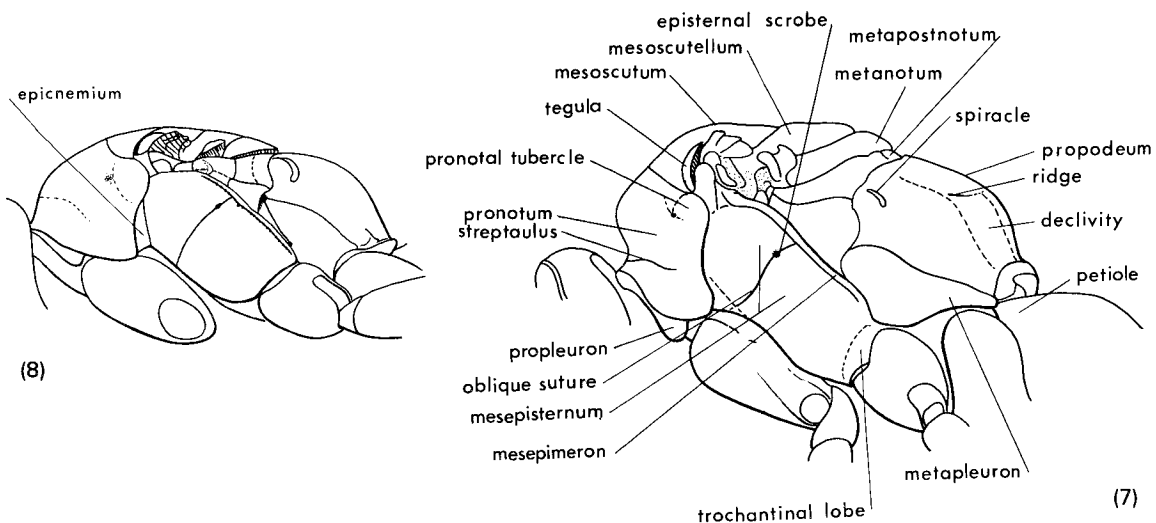

7, 8. Mesosoma, lateral, ♀
(*P. conformis* and *E. insularis*)

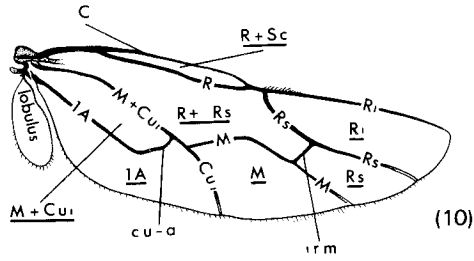
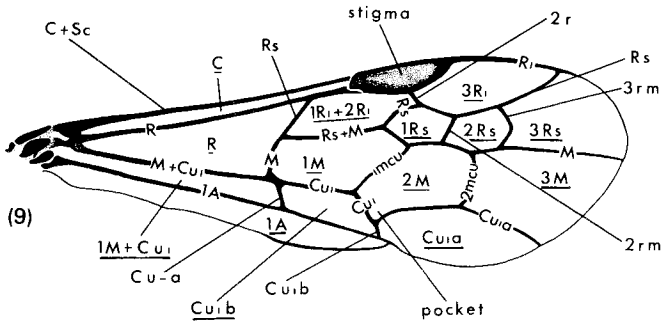

9, 10. Veins and cells in forewing and hind wing (*E. insularis*, ♂)

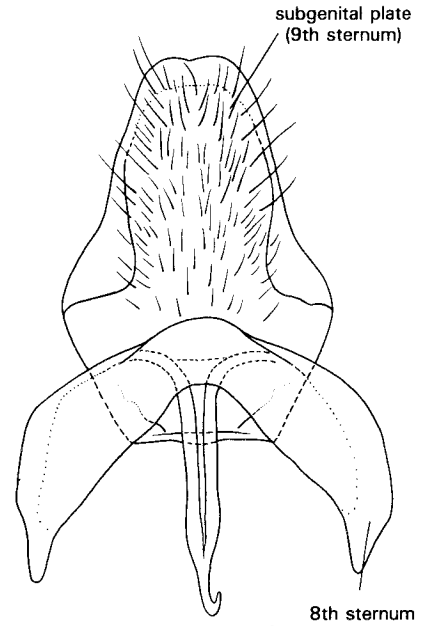

11. Subgenital plate, ♂ (*P. crawi*)

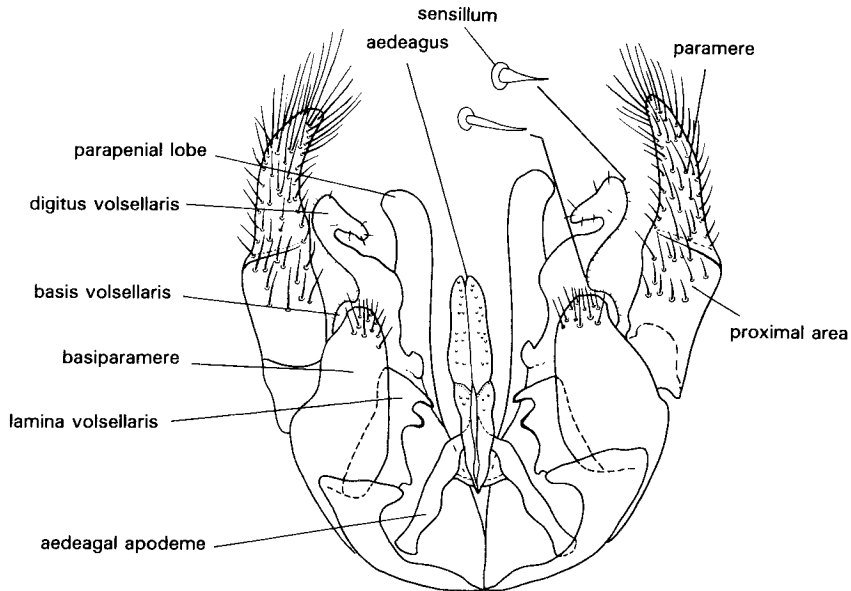

12. Genitalia, ♂ (*P. carbonarius*)

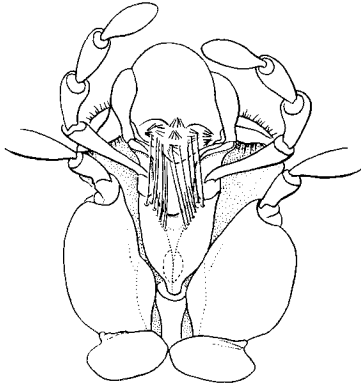

13. *P. monachus*

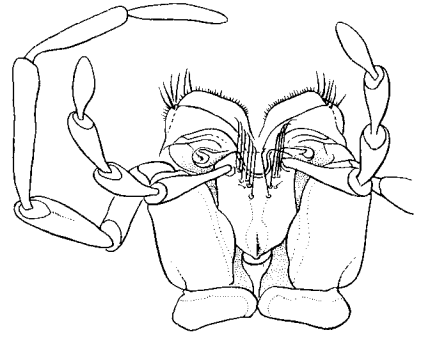

14. *P. conformis*

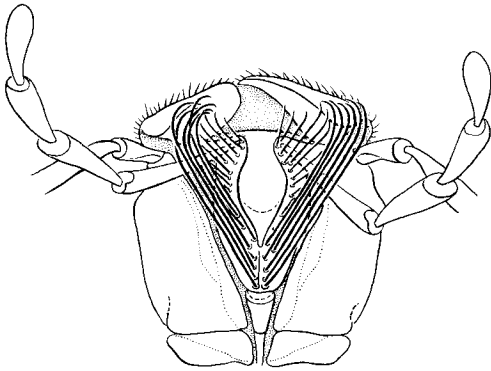

15. *S. nitidus*

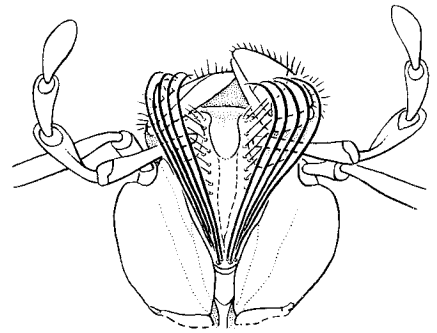

16. *S. calvus*

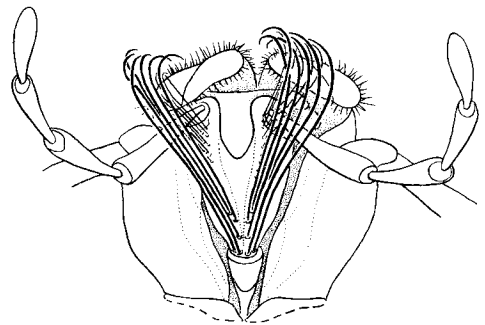

17. *S. fugax*

Figures 13–17 Labium and maxilla *in situ*, ventral view, ♀, showing particularly the difference between *Priocnemis* and *Sphictostethus* in development of premental bristles. For *P. carbonarius*, see Fig. 4.

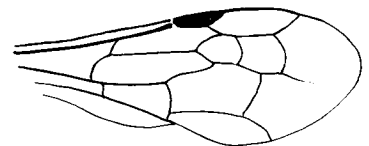
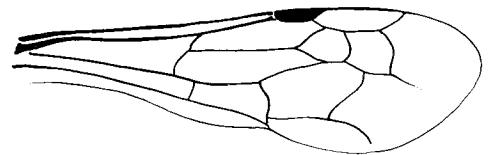
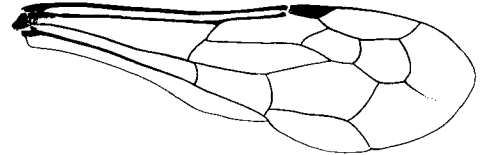
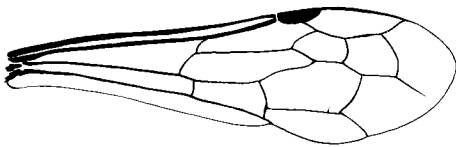
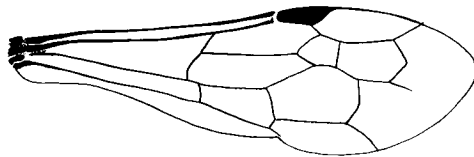
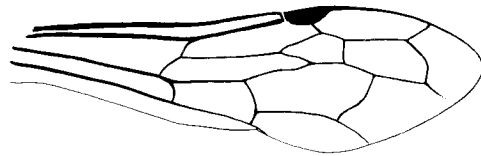
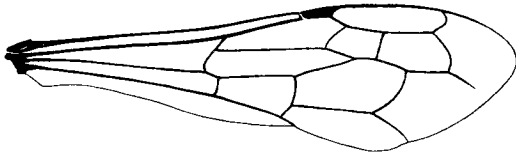
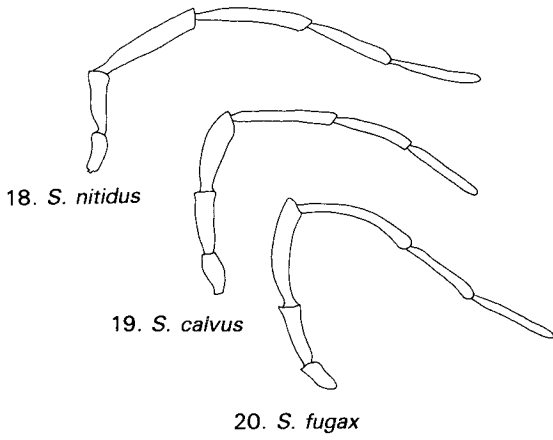

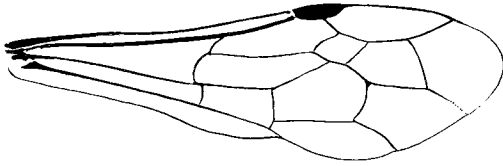

28. *S. nitidus*

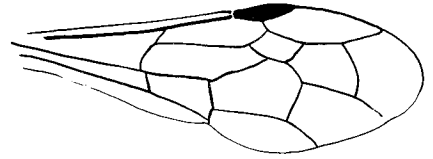

30. *S. fugax*

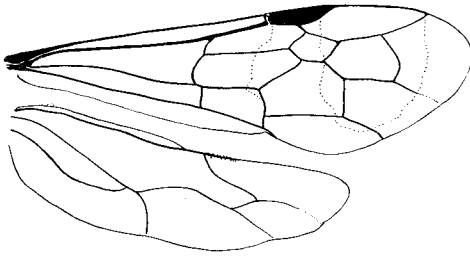

29. *S. calvus*

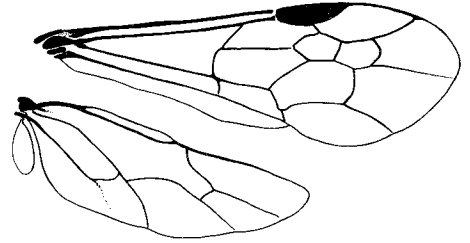

31. *E. insularis*

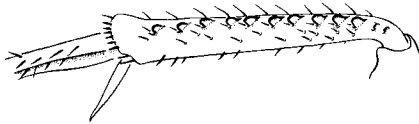

32. *P. monachus*

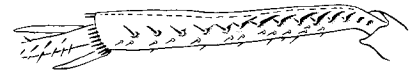

35. *S. nitidus*



33. *P. conformis*

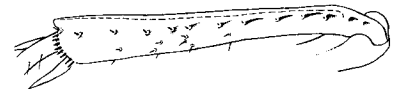

36. *S. calvus*

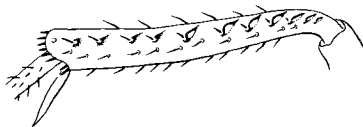

34. *P. carbonarius*



37. *S. fugax*

Figures 32-37 Hind tibia, dorsal view, ♀, showing appearance of row of scales.

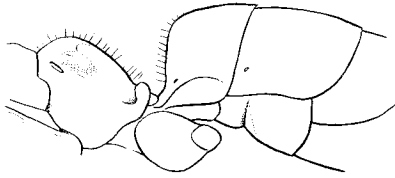

38. *P. monachus*, ♀

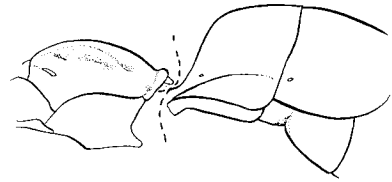

39. *P. conformis*, ♀

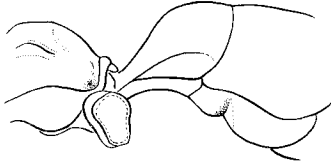

40. *S. nitidus*, ♀

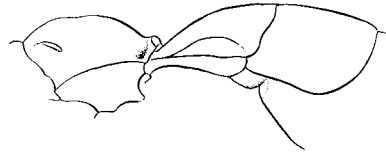

41. *S. fugax*, ♀

(42)

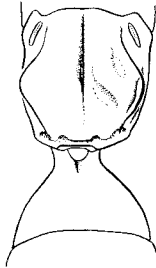

(44)



(46)

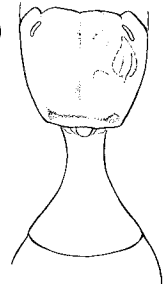

42, 43. *S. nitidus*, ♀ and ♂

44, 45. *S. calvus*, ♀ and ♂

46, 47. *S. fugax*, ♀ and ♂

(43)

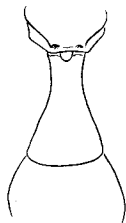

(45)

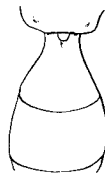

(47)

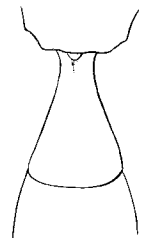

Figures 38–47 Propodeum and base of metasoma: 38–41, lateral view; 42–47, dorsal view.

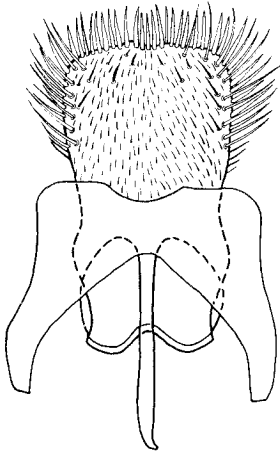

48. *C. australis*
Spirits Bay ND

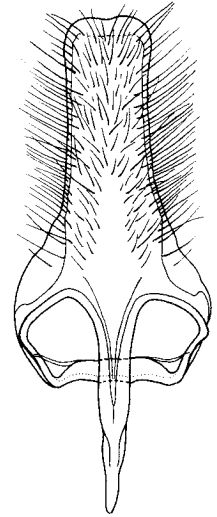

49. *P. monachus*
Renata WN

50a. *P. conformis*
Queenstown OL

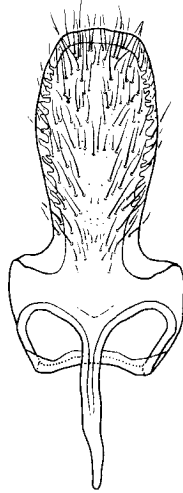

50b. *P. conformis*
Upper Maitai NN

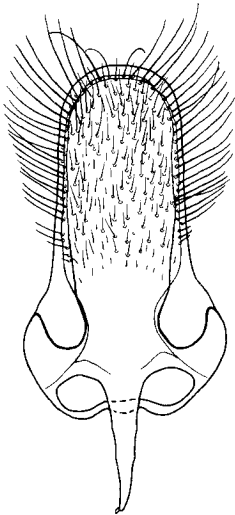
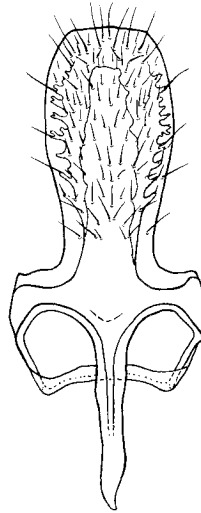

51. *P. nitidiventris*
Paekakariki Beach WN

52. *P. ordishi*
Renata WN

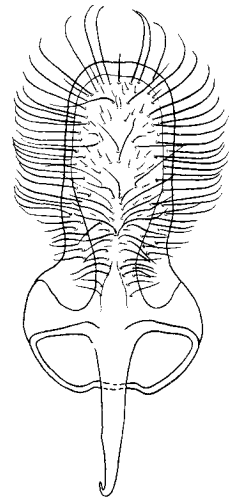

Figures 48-58 Subgenital plate, ♂.

53. *P. carbonarius*
Dun Mountain NN

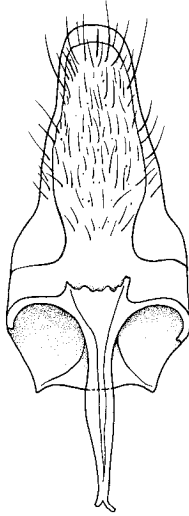

54a. *P. crawi*
Greymouth BR

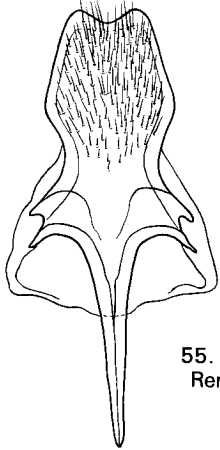
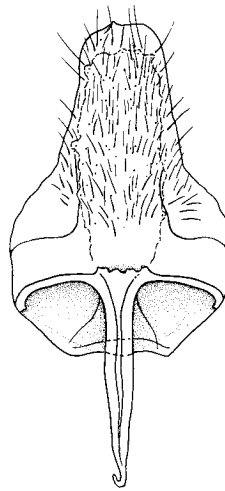

55. *S. nitidus*
Renata WN

54b. *P. crawi*
Rock and Pillar Range CO

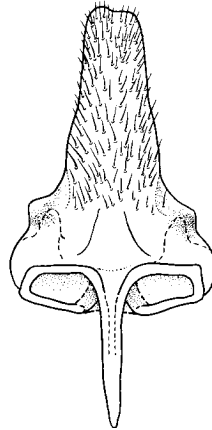
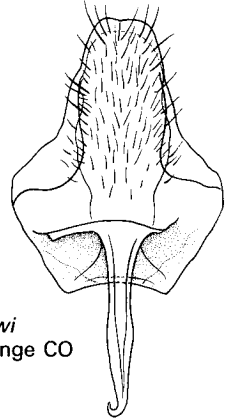

56a. *S. calvus*
Leith Saddle DN

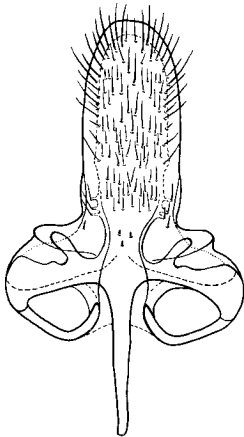

57. *S. fugax*
Wellington WN

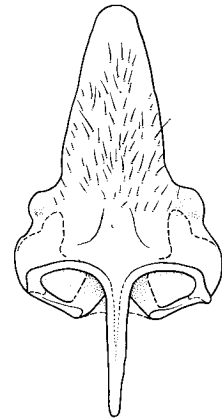

56b. *S. calvus*
Christchurch MC

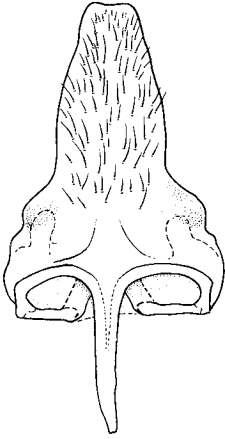

56c. *S. calvus*
St Arnaud Range BR-MB

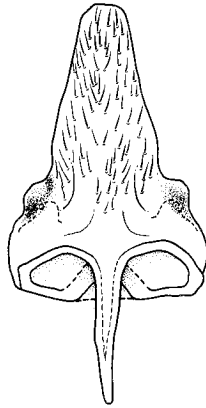

56d. *S. calvus*
Akatarawa WN

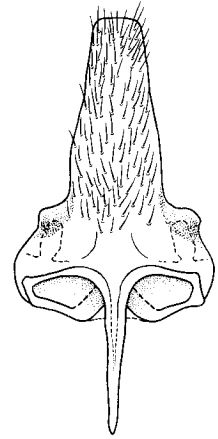

56e. *S. calvus*
Okaihau ND

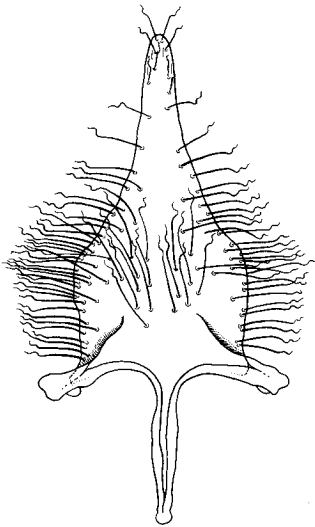

58a. *E. insularis*
Christchurch MC

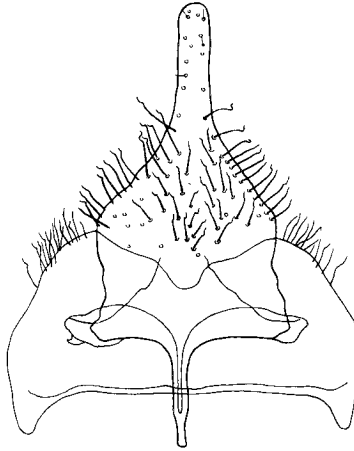

58b. *E. insularis*
Dun Mountain NN

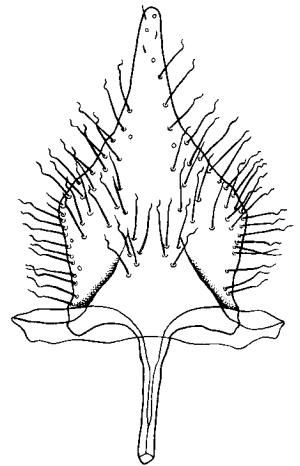

58c. *E. insularis*
Kaikoura KA

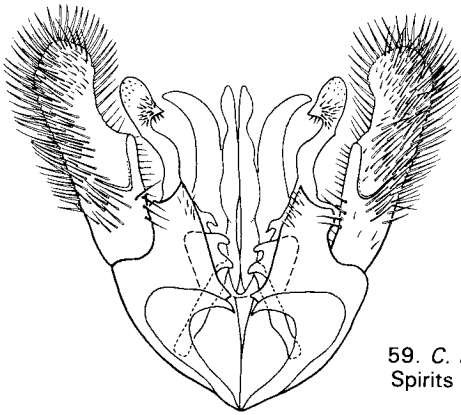

59. *C. australis*
Spirits Bay ND

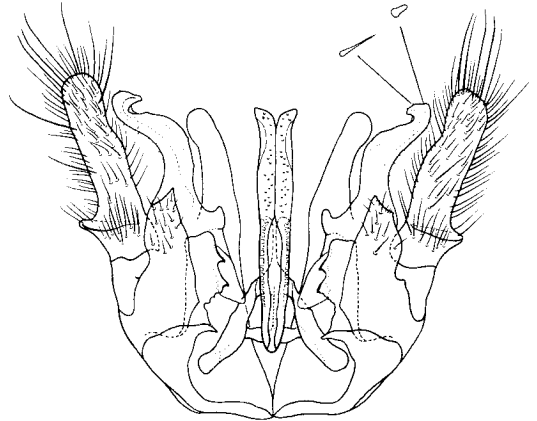

60. *P. monachus*
Maitai Reserve NN

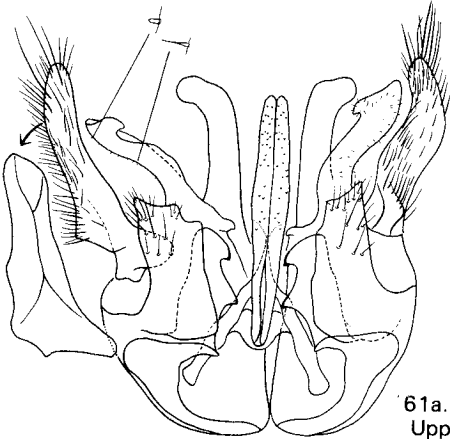

61a. *P. conformis*
Upper Maitai NN

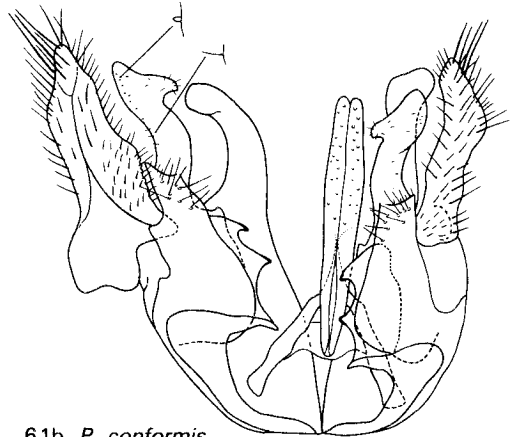

61b. *P. conformis*
The Remarkables OL

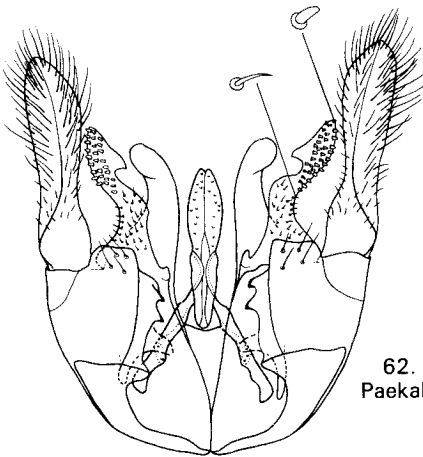

62. *P. nitdiventris*
Paekakariki Beach WN

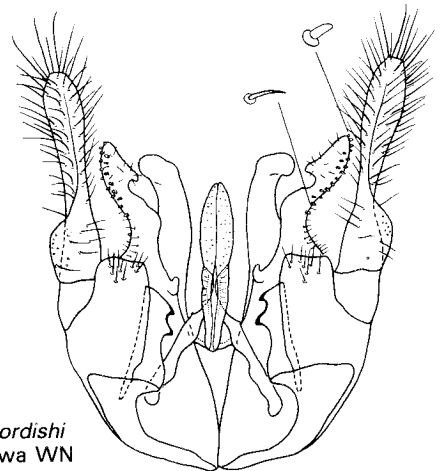

63. *P. ordishi*
Akatarawa WN

Figures 59–67 Genitalia, ♂.

12. (see also p. 118) *P. carbonarius*, Dun
 Mountain NN; *P. crawi* differs in lateral
 view only (see Key-fig. 10, p. 31)

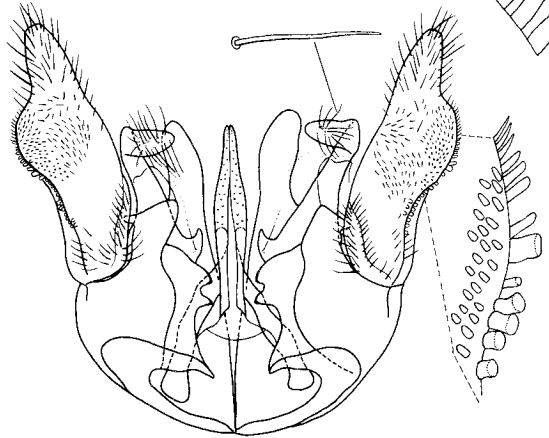
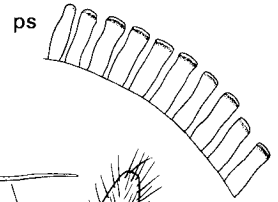
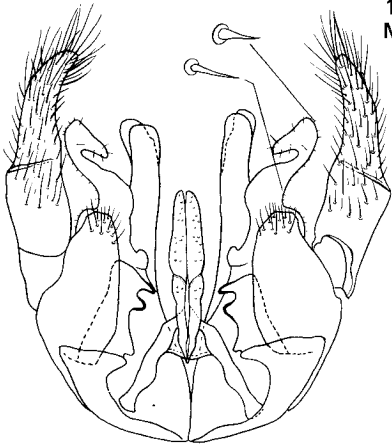

66. *S. fugax*
 Upper Maitai NN
 ps: peg setae from paramere



64. *S. nitidus*
 Akatarawa WN

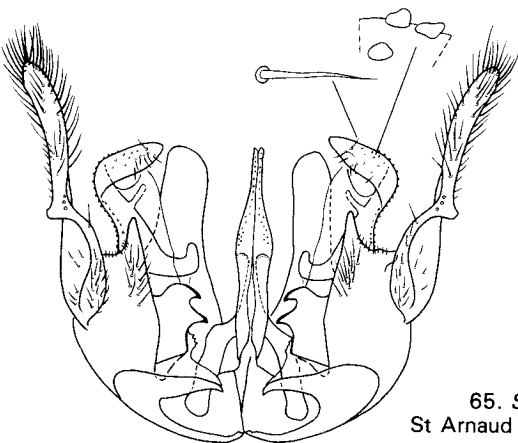

65. *S. calvus*
 St Arnaud Range BR-MB

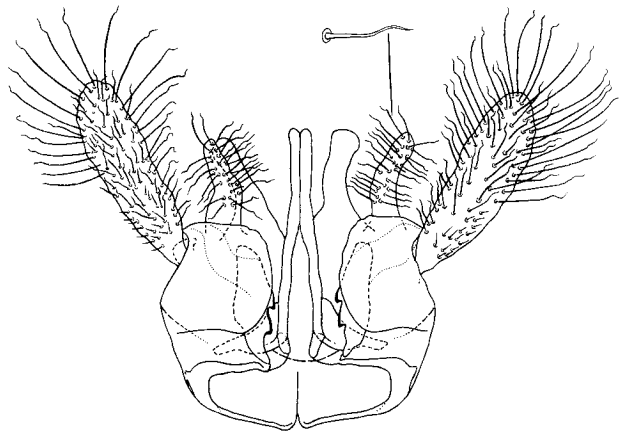

67. *E. insularis*
 The Brook NN

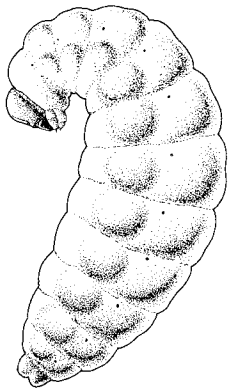

68. *C. australis*

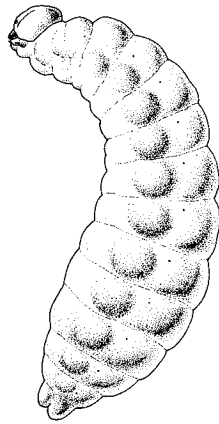

69. *P. monachus*

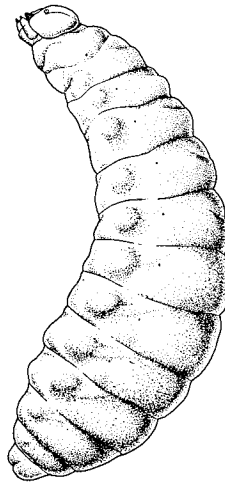

70. *P. conformis*

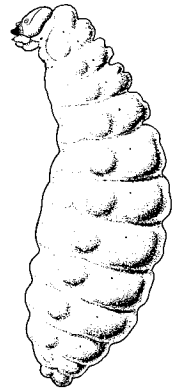

71. *P. nitidiventris*

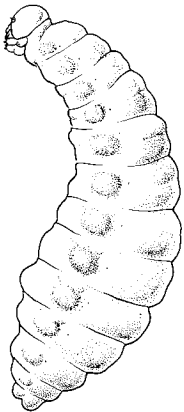

72. *P. carbonarius*

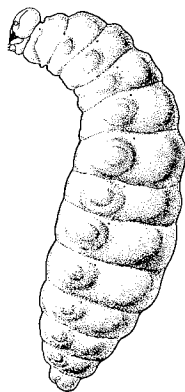

73. *S. nitidus*

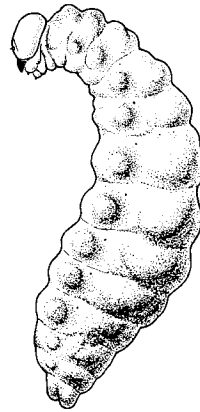

74. *S. fugax*

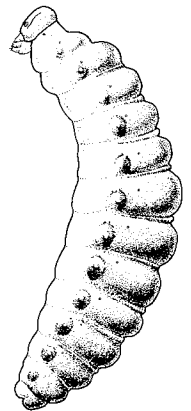

75. *E. insularis*

Figures 68–75 Habitus drawings, in lateral view, of final-instar larvae of some New Zealand Pompilidae.

(76)

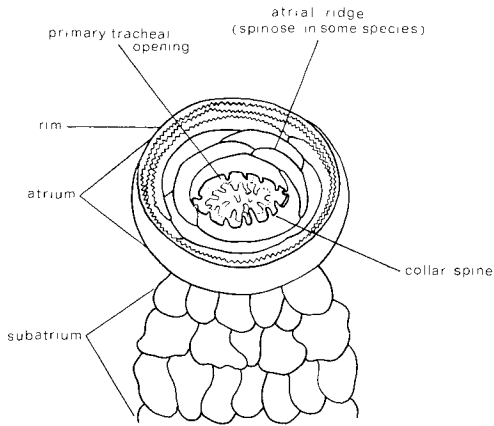

76, 77. First thoracic spiracle:
(76) whole mount; (77) LS.

(77)

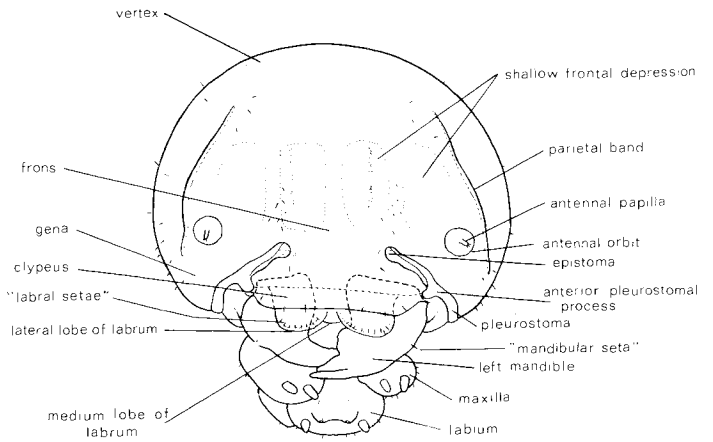
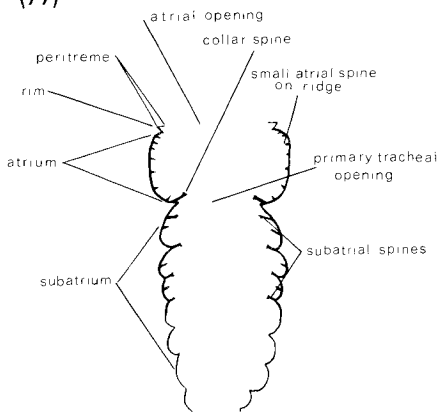

78. Head, facial view

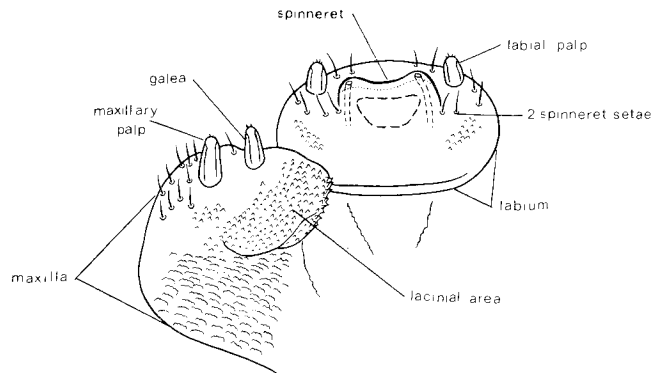

79. Labium and maxilla,
mature larva.

Figures 76-79 Schematic diagrams of morphological features, illustrating terminology used.

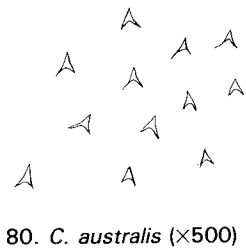

80. *C. australis* (×500)

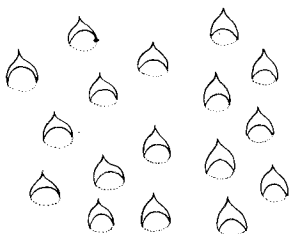

81. *P. conformis* (×440)

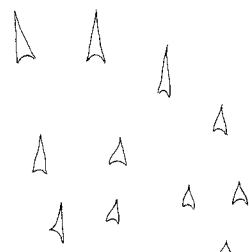

82. *P. nitidiventris* (×700)

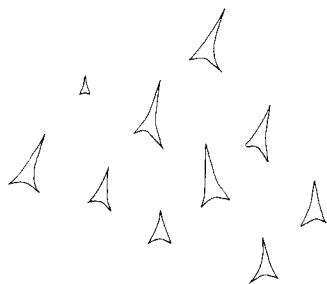

83. *P. ordishi* (×2000)

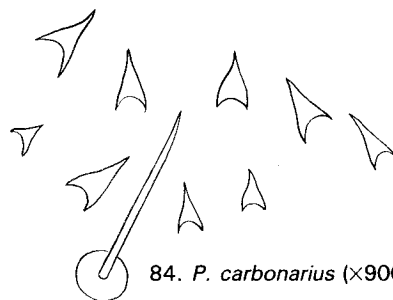

84. *P. carbonarius* (×900)

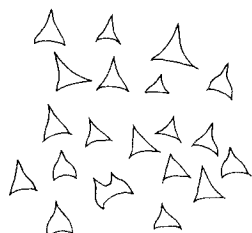

86. *S. calvus* (×1800)

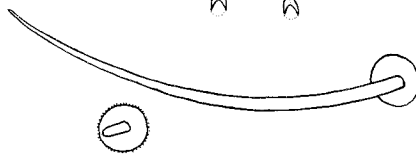

85. *S. nitidus* (×2250)

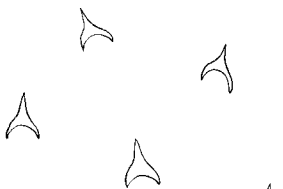

87b. *S. fugax* (×1150)

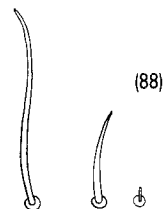

(88)

88, 89. *E. insularis*: (88) setae, dorsal (×230); (89) spicules, sternopleural (×2000)

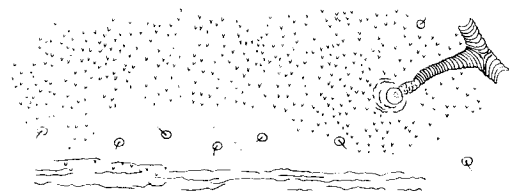

87a. *S. fugax* (×60)

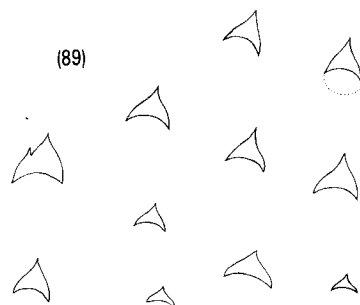

(89)

Figures 80–89 Spicules and setae in prothoracic sternopleural integument.

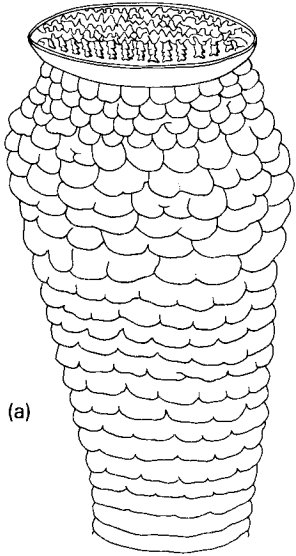

(a)

90a,b. *C. australis*

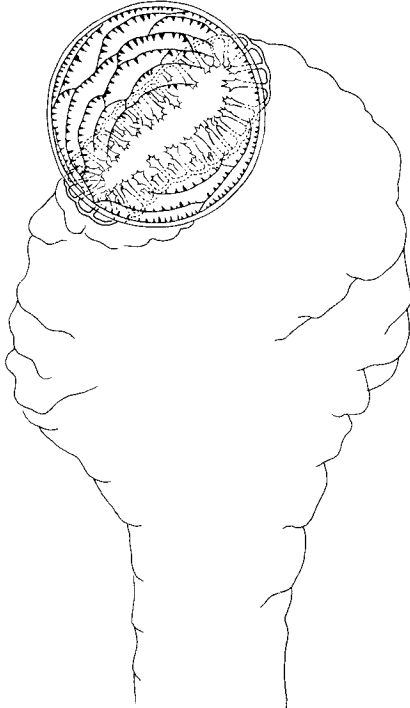

91. *P. monachus*

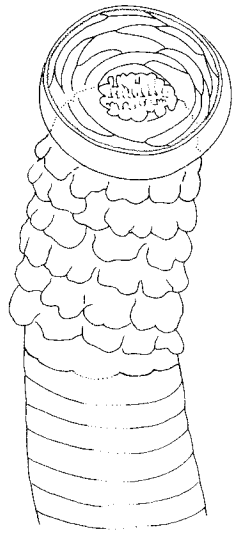

93. *P. nitidiventris*

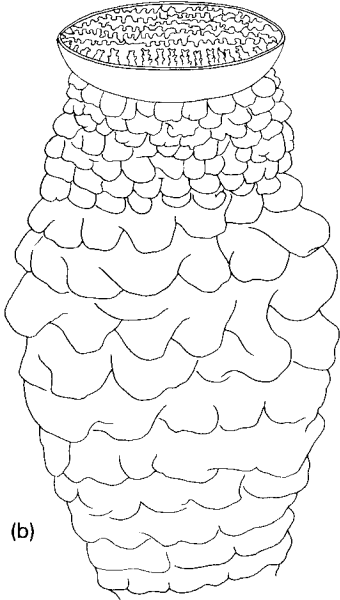

(b)

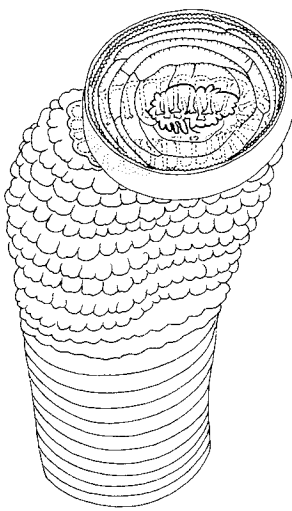

92. *P. conformis*

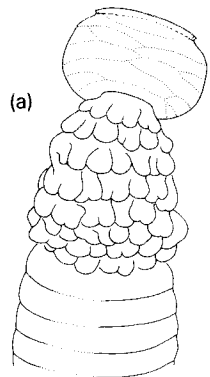

(a)

94a,b. *P. ordishi*

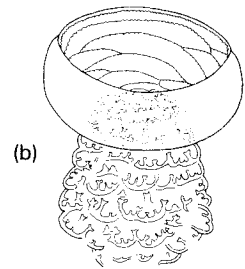

(b)

Figures 90-100 First thoracic spiracle.

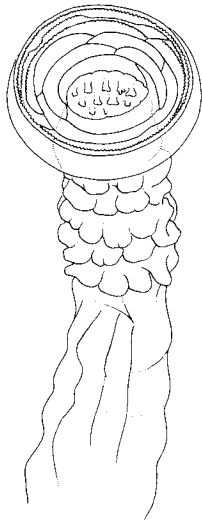

95. *P. carbonarius*

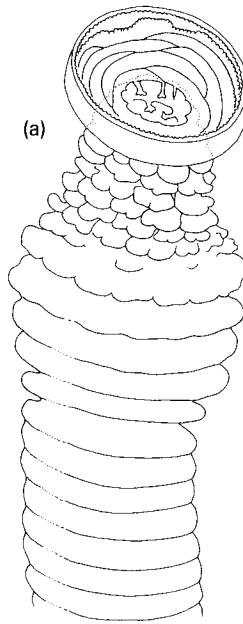

(a)



(b)

96a,b. *P. crawi*

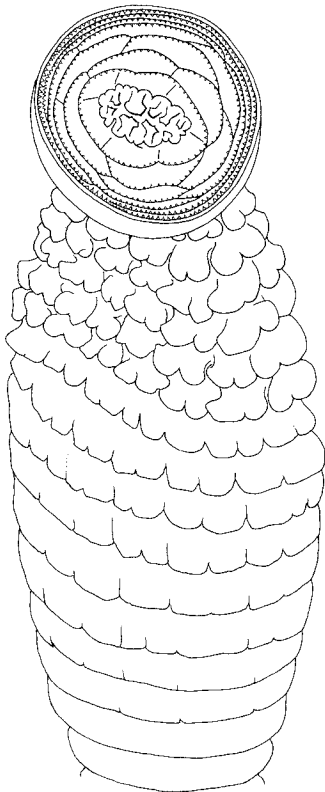

98. *S. calvus*

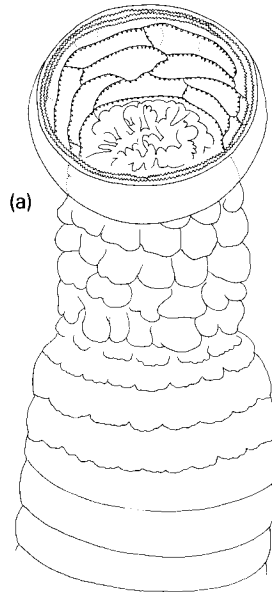

(a)

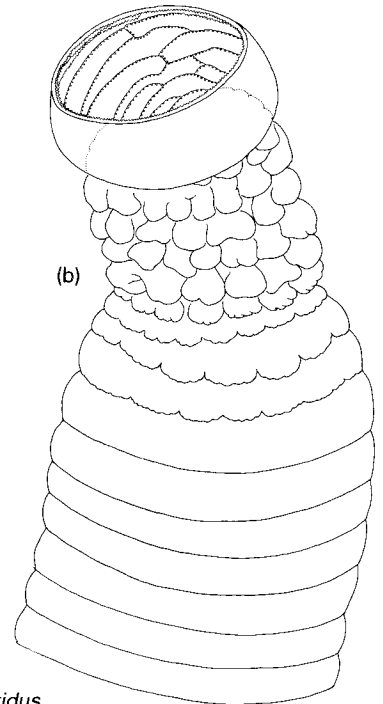

(b)

97a,b. *S. nitidus*

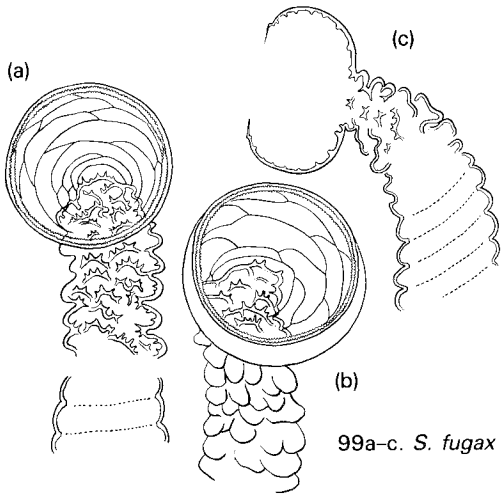

99a-c. *S. fugax*

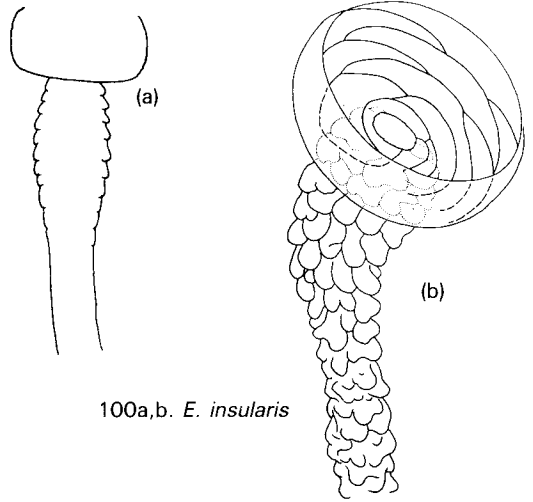

100a,b. *E. insularis*

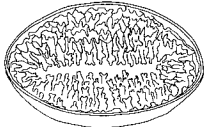

101. *C. australis*, atrium,
1st thoracic



(a)

102. *P. monachus*: (a) atrium, 1st tho-
racic; (b) distal subatrium, TS



103. *P. conformis*, atrium,
1st thoracic

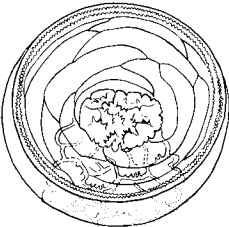

106. *S. fugax*, atrium,
1st thoracic

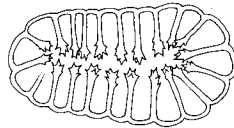

(b)

105. *S. calvus*, atrium,
1st thoracic

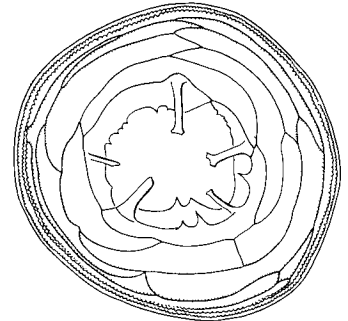
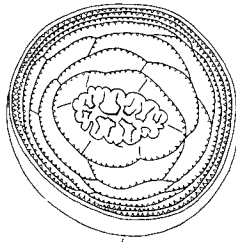

104. *P. nitidiventris*, atrium,
1st thoracic

Figures 101–109 Details of spiracular structure.



107. *P. monachus*, 2nd thoracic

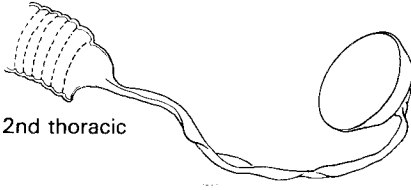

108. *S. fugax*, 2nd thoracic

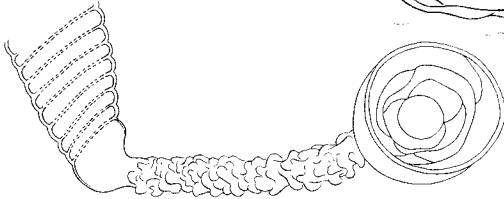

109. *E. insularis*, 2nd thoracic

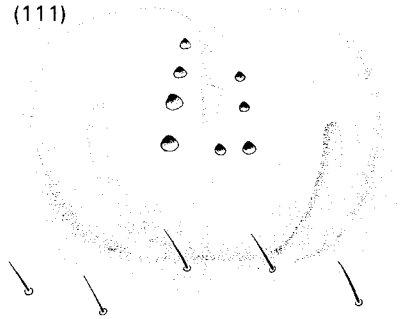
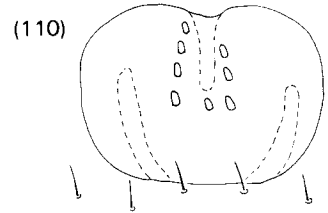
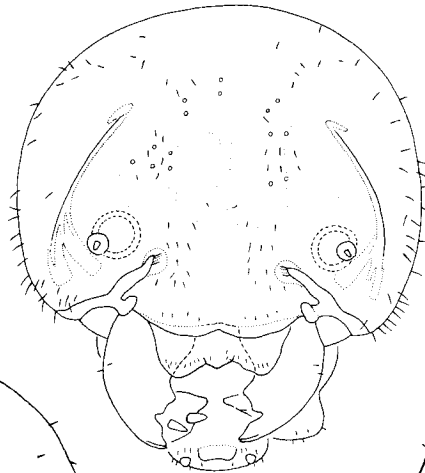
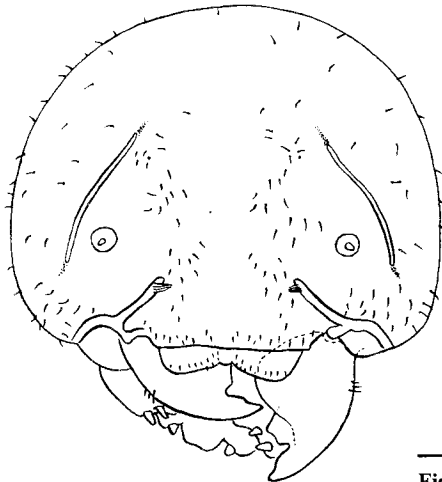

Figure 110 Dorsal thoracic shield, *Epipompilus insularis*, by reflected light. **111** same, but by transmitted light (different specimen).



113. *P. monachus*



112. *C. australis*

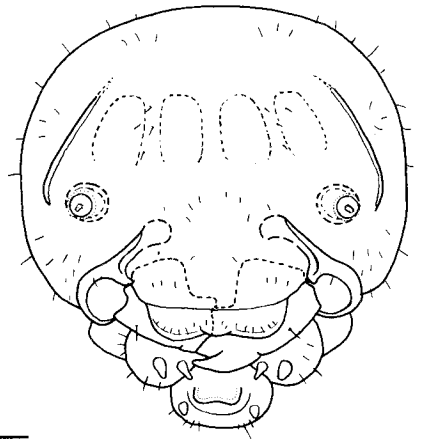

114. *P. conformis*

Figures 112–122 Head, facial view.

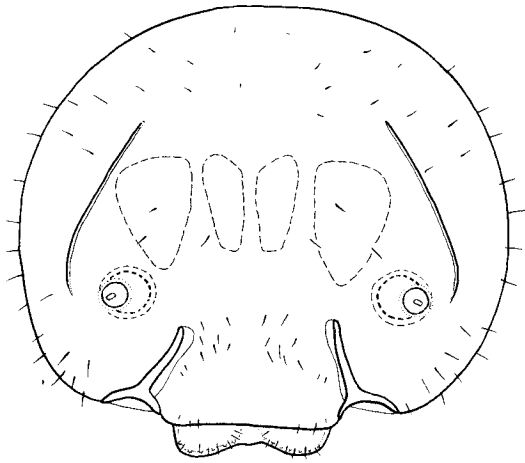

115. *P. nitidiventris*

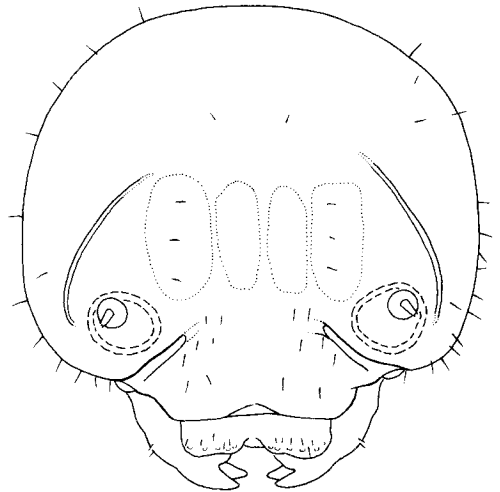

116. *P. ordishi*

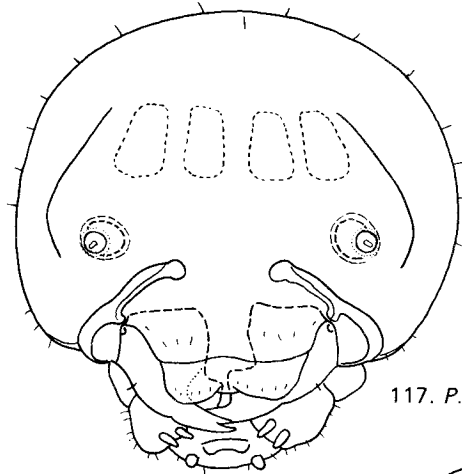

117. *P. carbonarius*

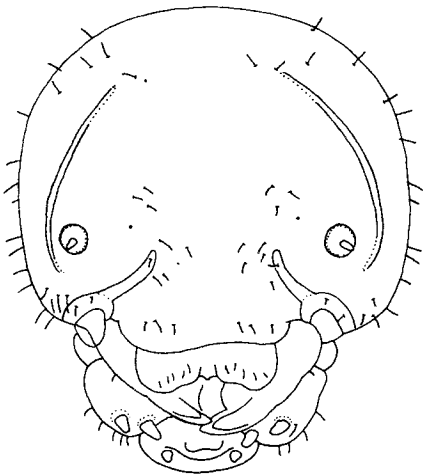

118. *P. crawi*

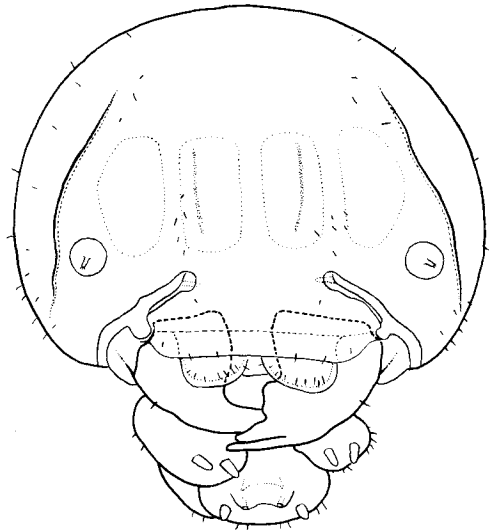

119. *S. nitidus*

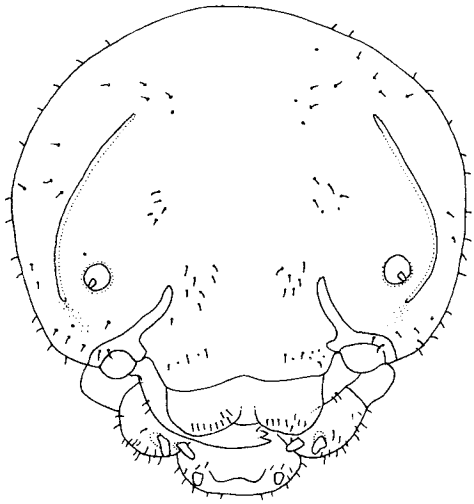

120. *S. calvus*

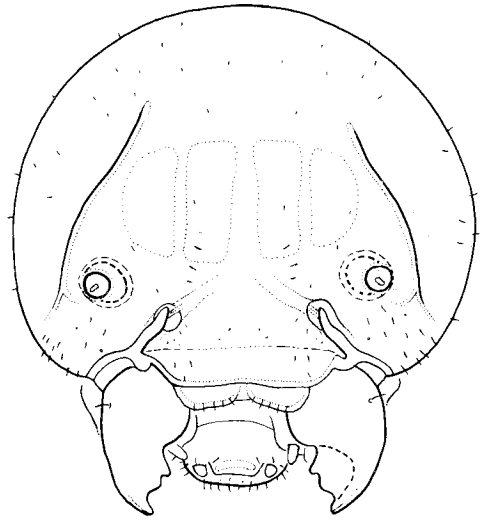

121. *S. fugax*

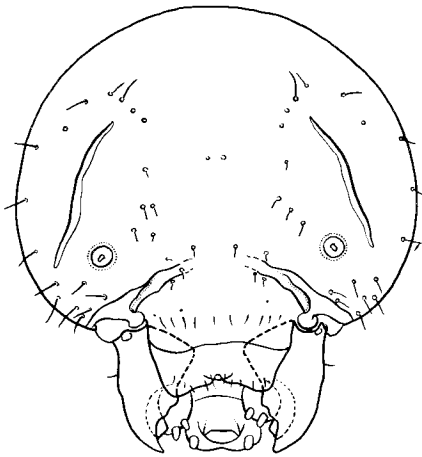

122. *E. insularis*

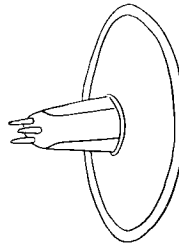

123. *C. australis*

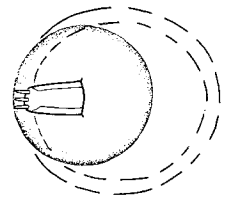

124. *P. conformis*

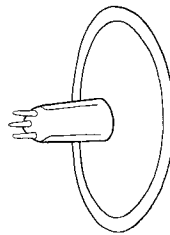

125. *P. nitidiventris*

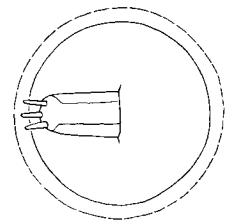

126. *P. carbonarius*

Figures 123–129 Antennal papilla.

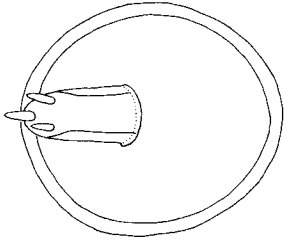

127. *P. crawi*

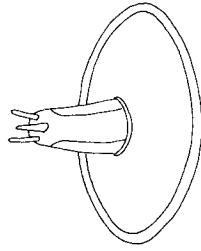

128. *S. calvus*

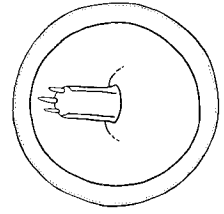

129. *E. insularis*

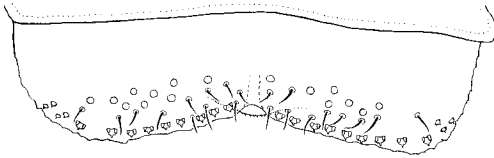

130. *C. australis*

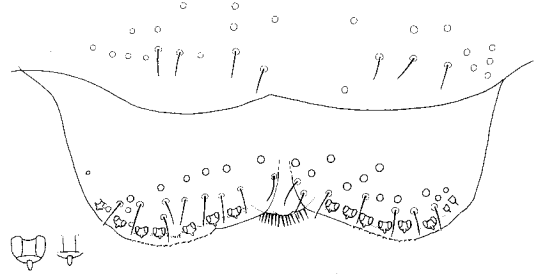

131. *P. monachus*

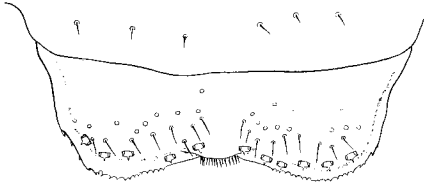

132. *P. conformis*

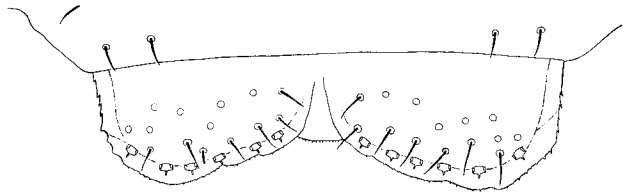

133. *P. nitdiventris*

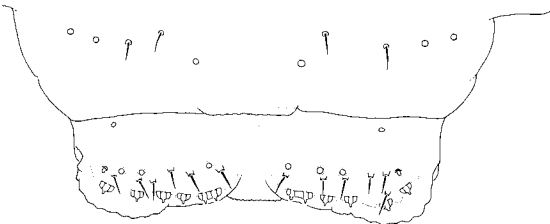

134. *P. ordishi*

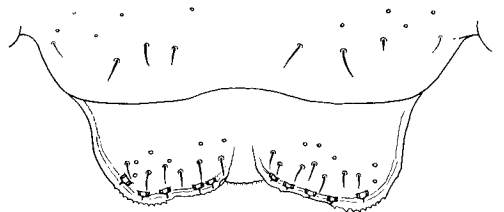

135. *P. carbonarius*

Figures 130-140 Labrum.

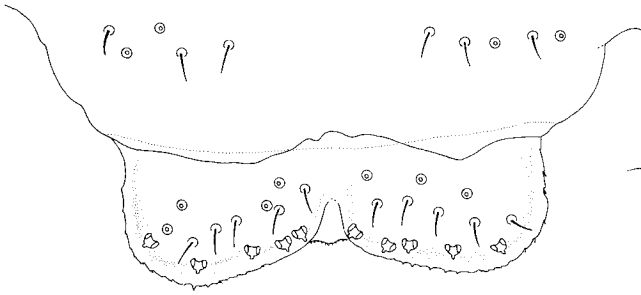

136. *P. crawi*

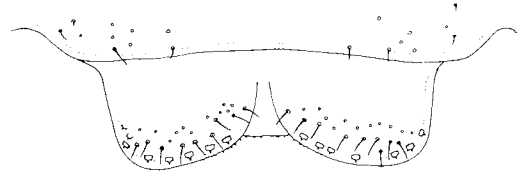

137. *S. nitidus*

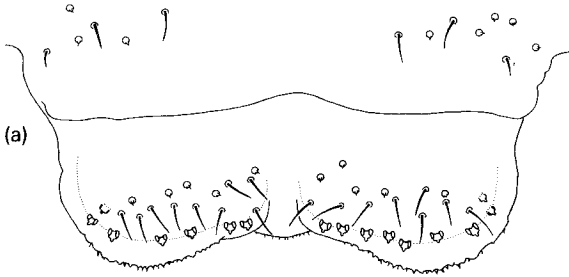

(a)

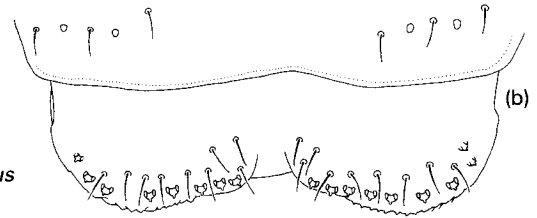

(b)

138a,b. *S. calvus*

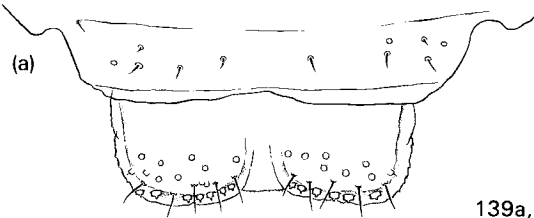

(a)

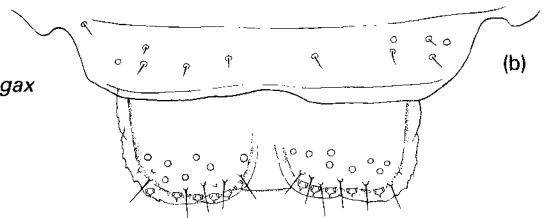

(b)

139a,b. *S. fugax*

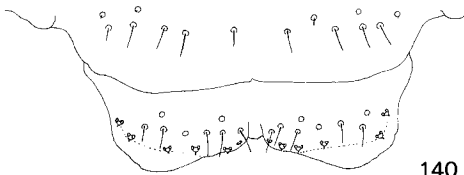

140. *E. insularis*

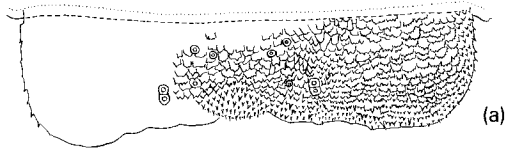

(a)

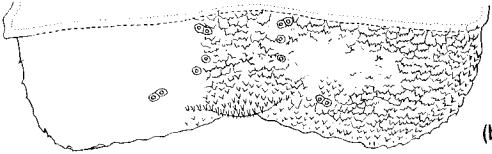

(b)

141a,b. *C. australis*

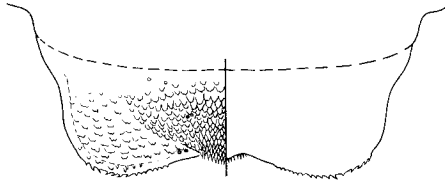

143. *P. conformis*

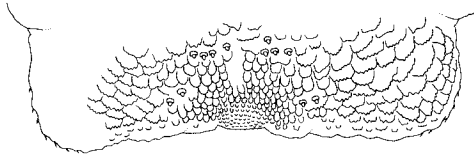

145. *P. ordishi*

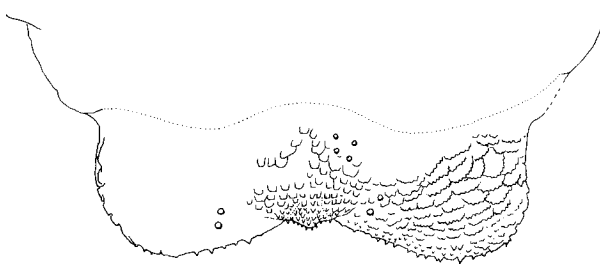

147. *P. crawi*

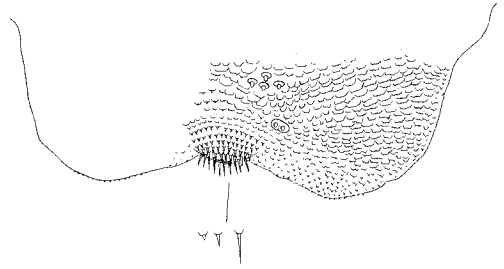

142. *P. monachus*

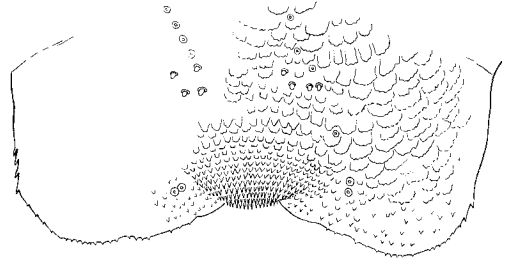

144. *P. nitidiventris*

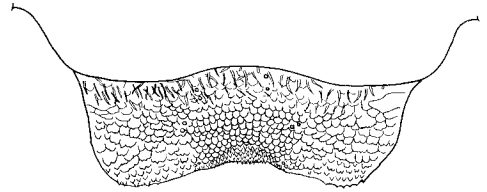

146. *P. carbonarius*

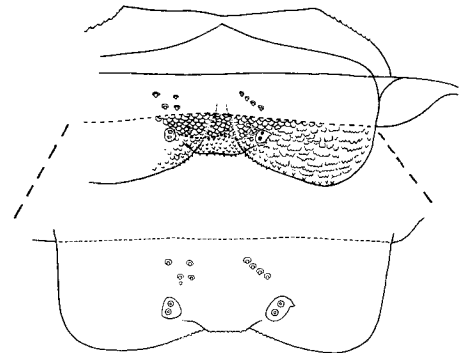

148. *S. nitidus* (projection: arrangement of large sense organs)

Figures 141–151 Epipharynx.

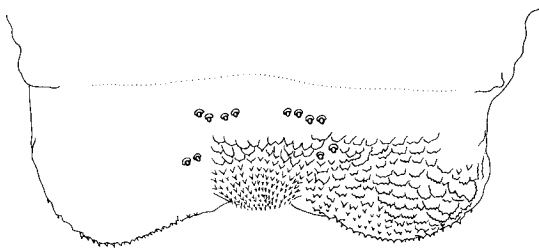

149. *S. calvus*

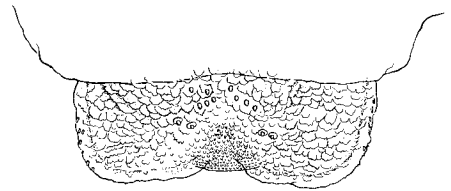

150. *S. fugax*

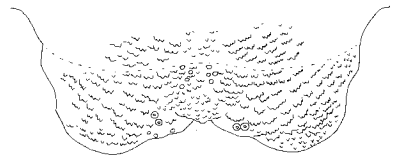

151. *E. insularis*

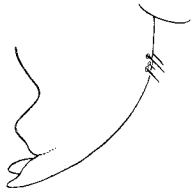

152. *C. australis*

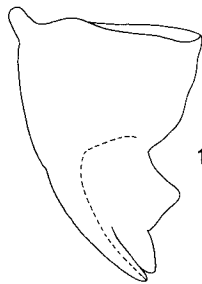

153. *P. conformis*

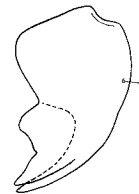

157. *S. fugax*

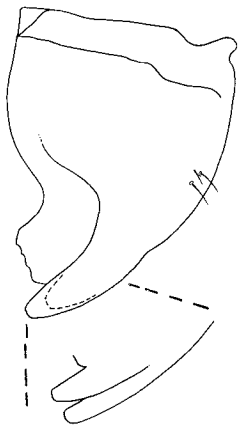

154. *P. nitidiventris* (projection:
apex, rotated 90°)

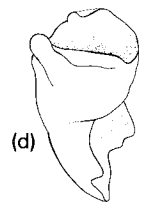
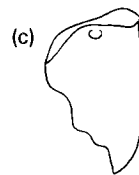
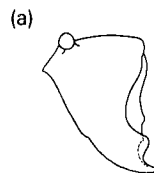

158a-d. *E. insularis*



155. *P. carbonarius*

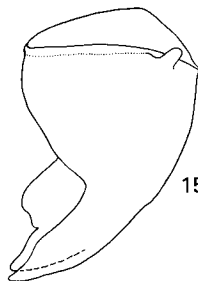

156. *S. nitidus*

Figures 152-158 Mandibles.

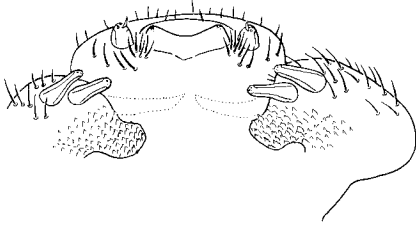

159. *C. australis*

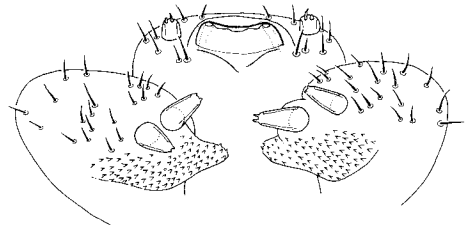

160. *P. monachus*

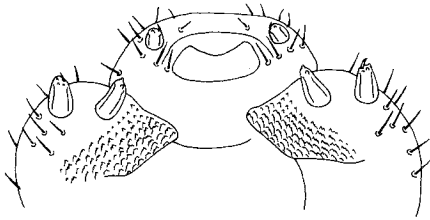

161. *P. conformis*

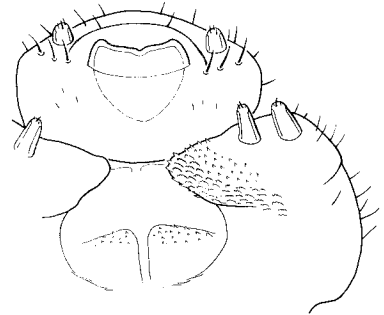

162. *P. nitdiventris*

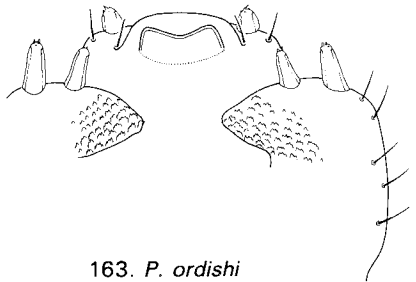

163. *P. ordishi*



164. *P. carbonarius*

Figures 159–169 Maxilla and labium, adoral aspect.

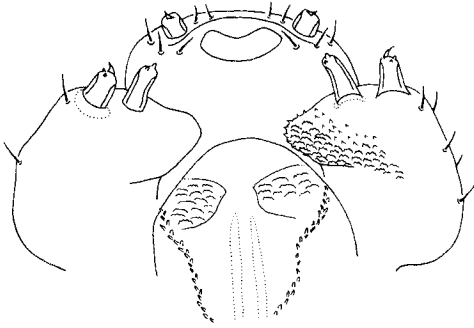

165. *P. crawi*

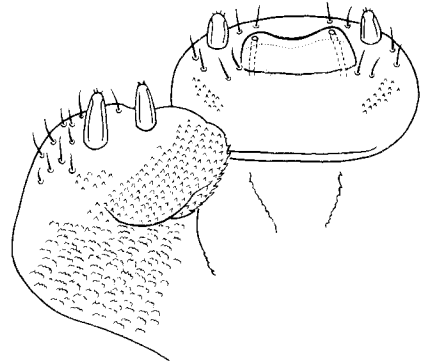

166. *S. nitidus*

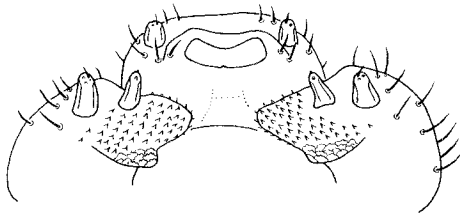

167. *S. calvus*

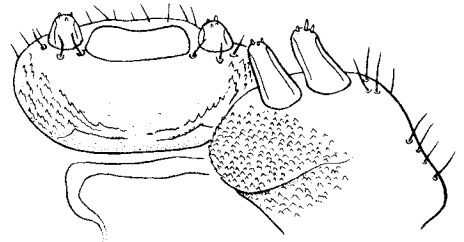

168. *S. fugax*

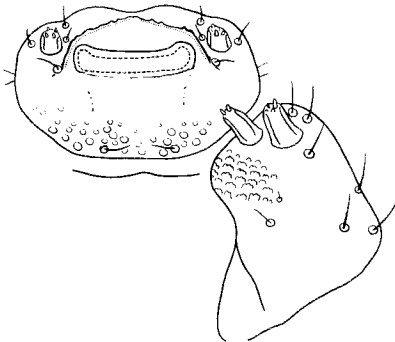

169. *E. insularis*

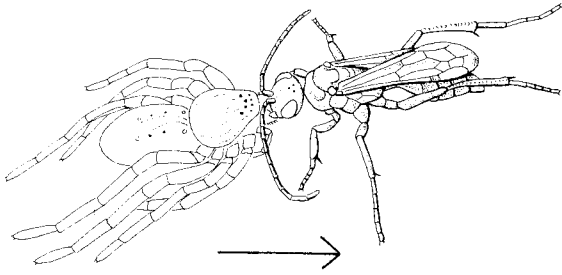

170. *C. australis* dragging *Dolomedes* sp.

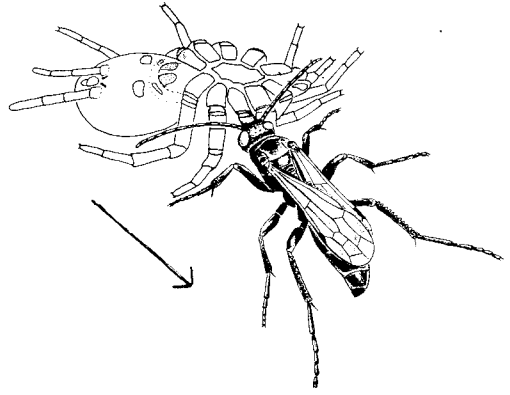

171. *P. monachus* dragging immature *Porrothele antipodiana*

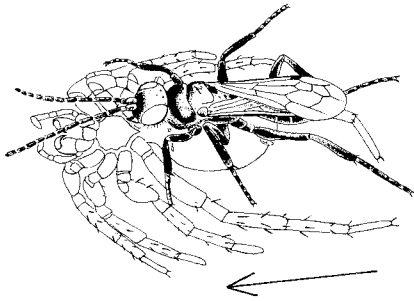

172. *P. nitidiventris* pushing large sand lycosid

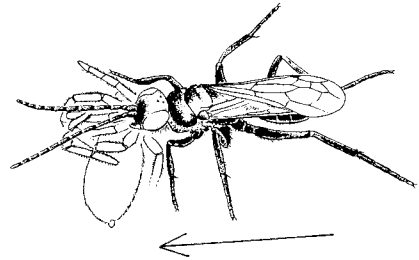

173. *P. ordishi* pushing prey

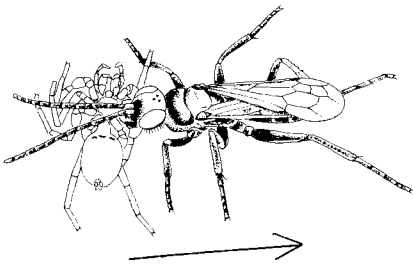

174. *P. carbonarius* dragging prey

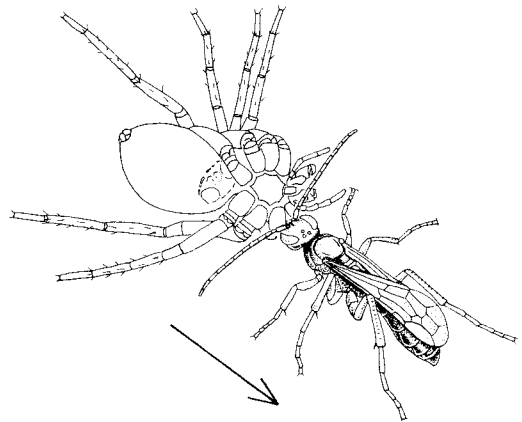

175. *S. nitidus* dragging *Miturga* sp.

Figures 170–175 Prey carriage; arrows indicate direction of movement.

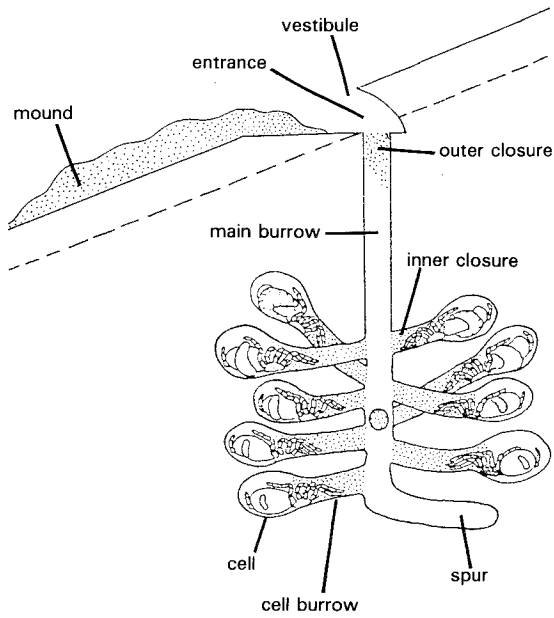
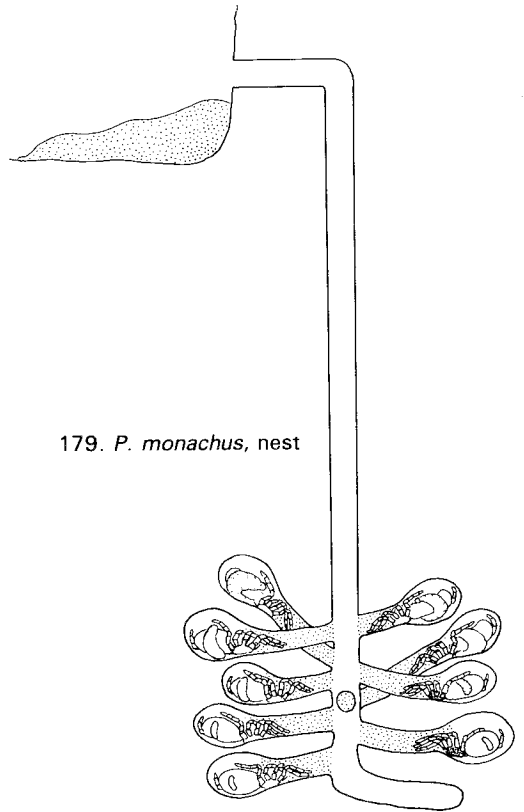
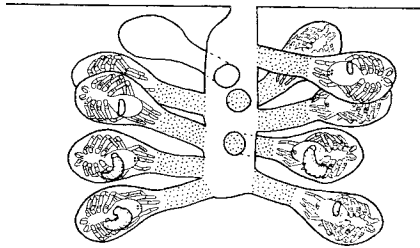

Figure 176 Schematic diagram of generalised nest, showing terminology used.



179. *P. monachus*, nest



177. *C. australis*, nest

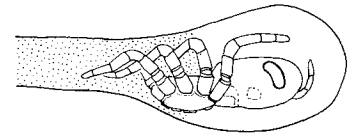

180. *P. monachus*, cell, prey, egg

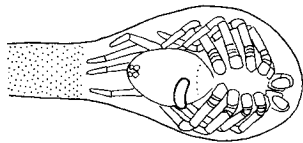

178. *C. australis*, cell, prey, egg



181. *P. conformis*, nest
(M, mat of spider web)

Figures 177–202 Nest structure, and position of egg on host spider.



182. *P. conformis*, burrow entrances
(1 true, 4 false)

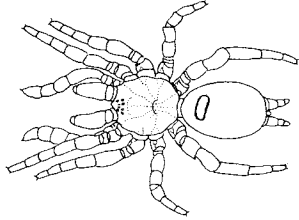

183. *P. conformis*, prey, egg

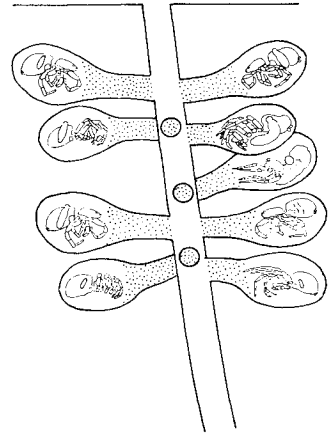

189. *P. carbonarius*, nest in upper part of
Leioproctus monticola burrow

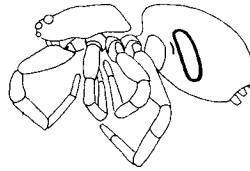

190. *P. carbonarius*, prey, egg

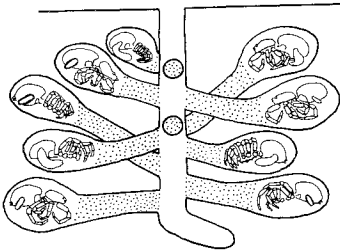

187. *P. ordishi*, nest

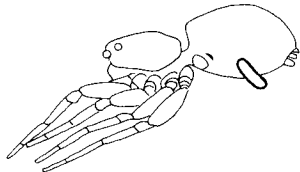

188. *P. ordishi*, host, egg



185. *P. nitidiventris*, nest entrance

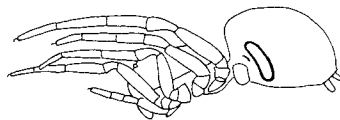

186. *P. nitidiventris*, prey, egg

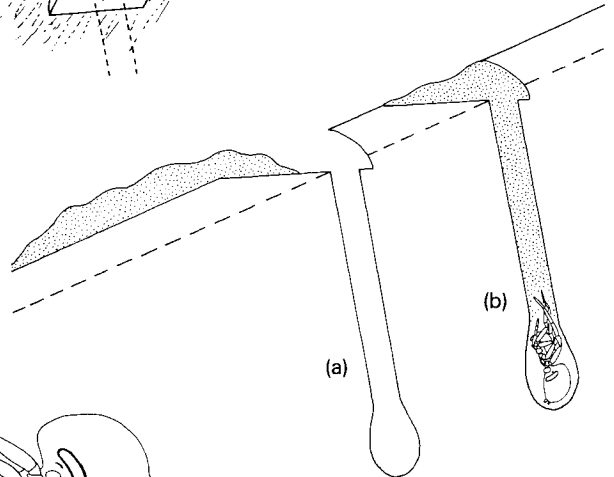

184. *P. nitidiventris*, nest: (a) newly excavated; (b) completed (pecked line — upper limit of moist sand)

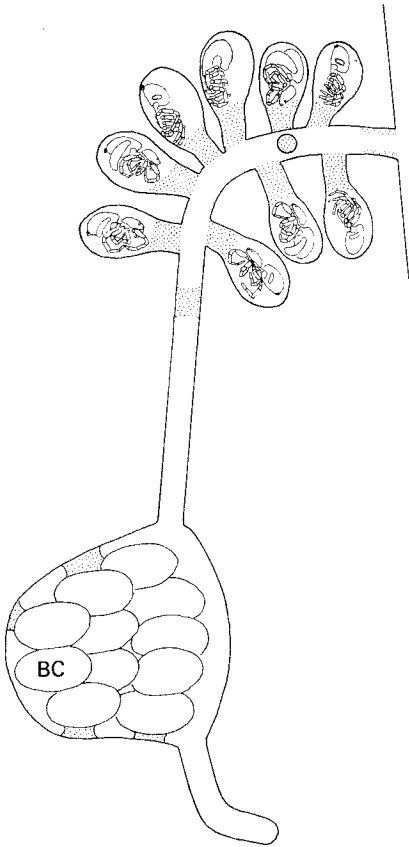

192. *P. crawi*, nest in upper part of *Lasioglossum sordidum* burrow (BC, bee cell)

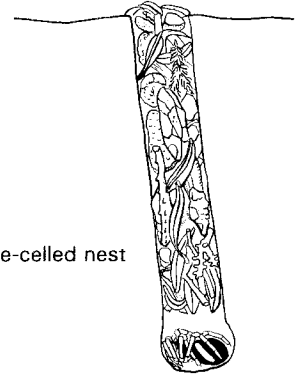

191. *P. crawi*, single-celled nest

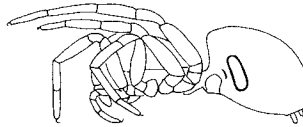

193. *P. crawi*, prey, egg

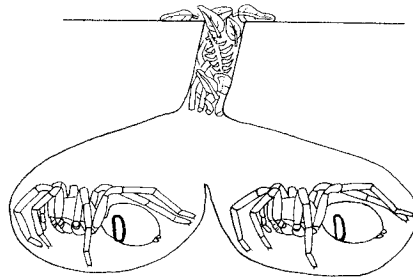

195. *S. nitidus*, 2-celled nest, prey, eggs

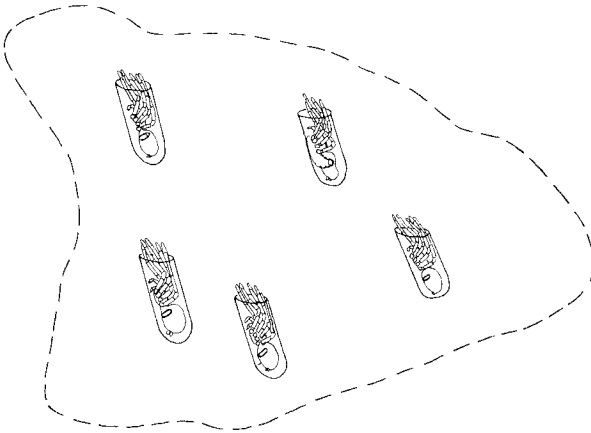

194. *S. nitidus*, 5-celled nest under stone (outlined)

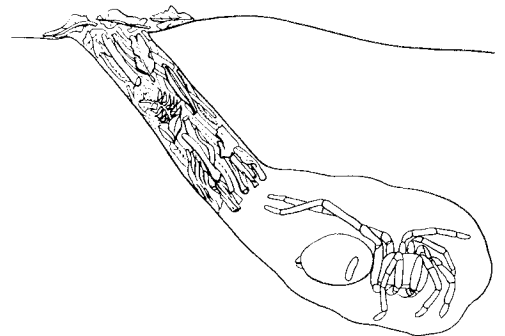

196. *S. nitidus*, single-celled nest

197. *S. calvus*, nest in rotting log,
prey, egg

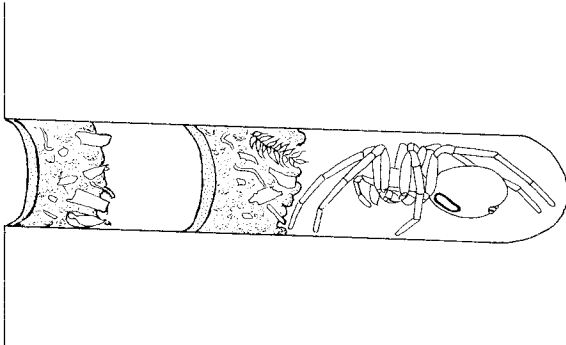
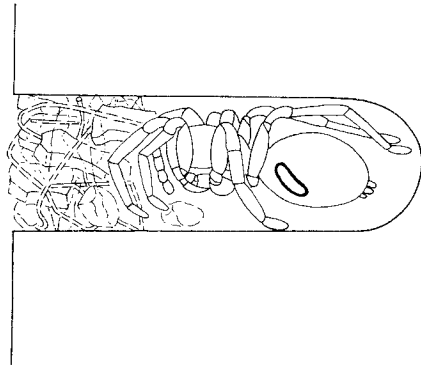

198. *S. fugax*, single-celled nest,
prey, egg

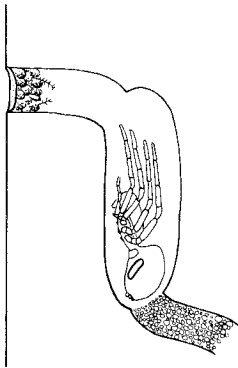

199. *S. fugax*, nest in empty
Psepholax sp. pupal chamber

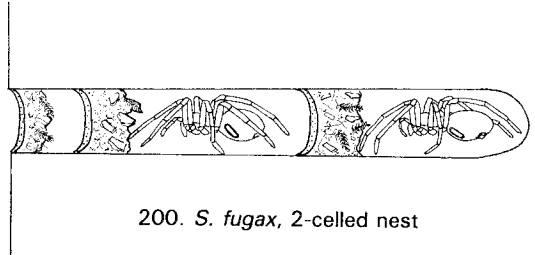

200. *S. fugax*, 2-celled nest

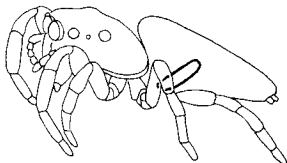

201. *E. insularis*, prey
(*Trite auricoma*), egg

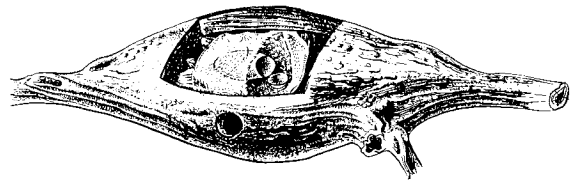

202. *E. insularis*, cocoon in cocoon
of *Clubiona huttoni*

Figures 203–213 Cocoons (scale 2× life-size): (203) *Cryptocheilus australis*; (204) *Priocnemis monachus*; (205) *P. conformis*; (206) *P. nitidiventris*; (207) *P. ordishi*; (208) *P. carbonarius*; (209) *P. crawi*; (210) *Sphictostethus nitidus*; (211) *S. calvus*; (212) *S. fugax*; (213) *Epipompilus insularis*. **214–217** Cocoon walls, transverse section: (214) *P. monachus*; (215) *S. nitidus*; (216) *S. fugax*; (217) *E. insularis* (all to same scale). **218** Pupa, *C. australis*: (a) dorsal view; (b) ventral. **219** Pupa, *E. insularis*, lateral.

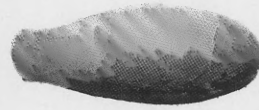

(203)

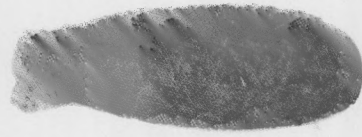

(204)

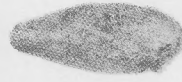

(205)



(206)

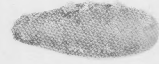

(207)



(208)



(209)



(210)

(a)

(b)



(211)



(212)



(213)

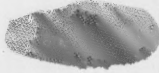

(214)

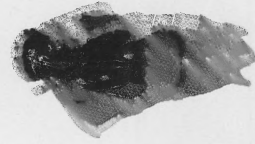

(215)

(a)

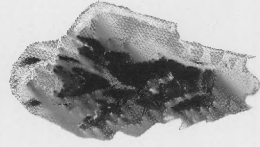

(b)

(216)

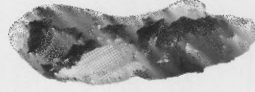

(217)

(217)

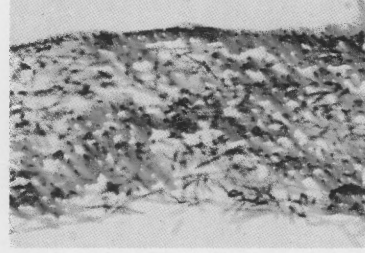
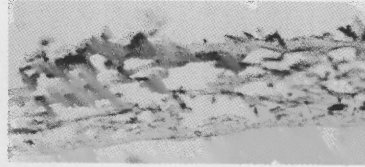
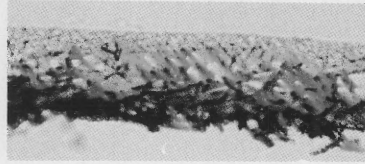



(220)

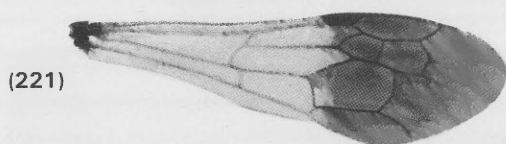

(221)



(222)

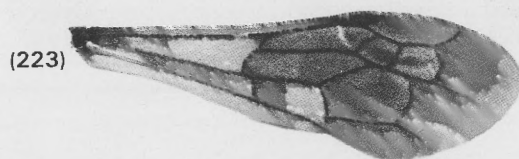

(223)

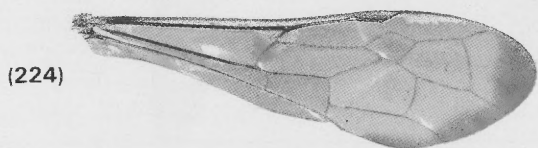

(224)



(225)

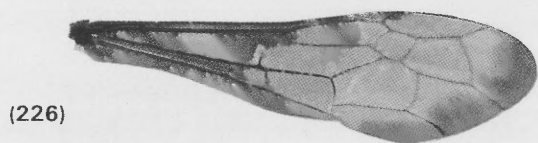

(226)

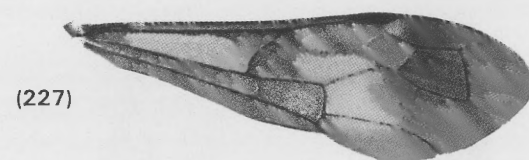

(227)

Figures 220–236 Forewings of colour-variable species, to show characteristic patterns of banding and darkening. 220–223 *Priocnemis conformis* (220, ♀, Mt Unuwhao ND; 221–223, ♀, ♂, ♂, Lee Bay SI). 224–227 *Sphictostethus nitidus* (224, ♀, Northland form, Kawakawa ND; 225, ♀, central and southern North I. form, Wellington WN; 226, ♀, South I. form, Waimate SC; 227, ♂, central and southern North I. form, Wellington WN). 228–230 *S. calvus* (228, ♀, typical form, Dunedin DN; 229, ♀, abbreviated fascia, Christchurch MC; 230, ♂, typical form, Dunedin DN). 231–234 *S. fugax* (231, ♀, Kawakawa ND; 232, ♀, Wellington WN; 233, ♀, Trotters Gorge DN; 234, ♂, typical form, Lee Bay SI). 235, 236 *Epipompilus insularis* (235, ♀, Mt Unuwhao ND; 236, ♀, Dunedin DN).

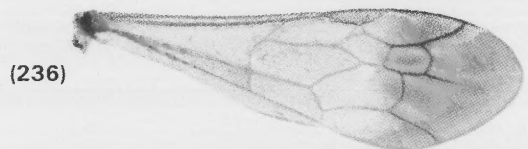
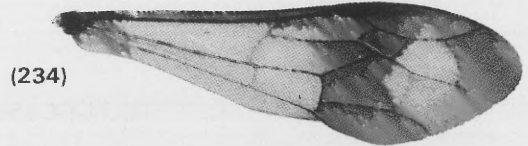
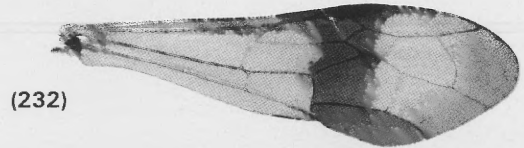
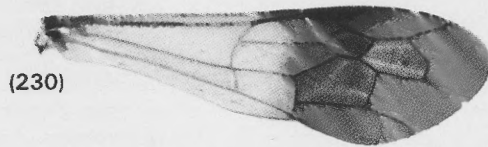
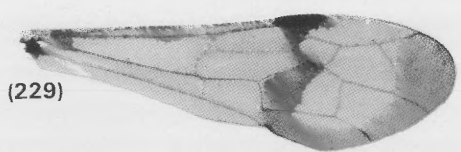

TAXONOMIC INDEX

- Achaearana* sp. 112
affinis, *Cryptocheilus* 29
Agenia 93
albopilosus, *Chirodamus* 30
aliciae, *Calopompilus* 64
 Sphictostethus 17, 64
allani, *Cantuaria* 112
Allaporus 94
Amphinecta sp. 113
Anapriocnemis 63
annulata, *Sphex* 25
antipodiana, *Cambridgea* 113, 114
 Porrhothele 35, 74, 112, 113
antipodus, *Saropogon* 15
apicalis, *Benhamyia* 15
apogona, *Haploneura* 63
apogonum, *Haploneurion* 64
Aporini 94
Aporus 94
aquaticus, *Dolomedes* 112, 113
arboricola, *Cambridgea* 113, 114
Aulocostethus 94, 95
Auplopodini 19, 64
Auplopus 18, 64
auricoma, *Trite* 102, 112–114
australis, *Cryptocheilus* 10, 17, 18, 24k, 25, 37,
 70, 112
 Pompilus 25

barbifrons, *Psepholax* 79
Batozonellus 16
bicolor, *Salius* 25, 29
 Sphex 25
bifuscatus, *Aulocostethus* 95
brouni, *Agenia* 93
 Salius 84, 93
brownii, *Agenia* 10, 84, 90, 93
 Pseudagenia 84
bushi, *Epipompilus* 17, 95

cada, *Clubiona* 114
calvus, *Sphictostethus* 13–16, 19, 24k, 39, 64, 65k,
 66k, 67, 76, 85, 87, 88, 93, 108, 109, 111, 113
Cambridgea spp. 114
cambridgei, *Clubiona* 114
cantuaria, *Notomatachia* 114
Cantuaria spp. 35, 44, 112
carbonarius, *Pompilus* 46, 55
 Priocnemis 13, 15, 17, 20, 21, 24k,
 30–33k, 50, 54, 55, 60–63, 75,
 108–110, 113
 Salius 46, 55
carbonarius group 54
centralis, *Toxopsiella* 113
 CEROPALINAE 24

Chelaporus 94
Chirodamus 29, 30, 64
Chrysocurgus 63, 64
Clubiona spp. 102, 113, 114
comparatus, *Pompilus* 25
conformis, *Priocnemis* 10, 13–17, 20, 24k, 28, 29,
 30–33k, 35, 37, 38, 50, 51, 58, 66, 71, 75, 108–
 110, 112
 Salius 38
consensa, *Clubiona* 113, 114
conspirator, *Aucklandella* 15
contrita, *Clubiona* 114
convoluta, *Clubiona* 114
crawi, *Priocnemis* 13, 15, 17, 20, 21, 24k, 30, 32k,
 33k, 54–56, 58, 59, 108–110, 113
cristatus, *Hybolasius* 92
Cryptocheilus 22k, 25
cupreapercara, *Gynoplistia* 15
Cycloctenus sp. 114

dalmasi, *Ixeuticus* 114
 Neolanus 114
dauidi, *Degithina* 15
decemmaculata, *Amphinecta* 113
decepta, *Degithina* 15, 16
decoratoria, *Levansa* 15
diligens, *Priocnemis* 14, 27, 38, 43, 48
 Salius 38
Dipogon 18, 19, 64
Dolomedes spp. 112, 113
Dromochares 94

Epicostethus 95
Epipompilini 17, 22k, 94
Epipompiloides 95
epipompilus, *Pompilus* 95
Epipompilus 17, 18, 22k, 94, 95
Episyron 17
erebus, *Taieria* 114
exaltata, *Priocnemis* 20, 30
 Sphex 29
exhilarata, *Degithina* 15
extenuatus, *Saropogon* 15

fasciata, *Cambridgea* 114
Ferreola 94
Ferreoloides 94
flaviceps, *Pompilus* 64
flavipes, *Pompilus* 63, 64
foliata, *Cambridgea* 112, 113
frenata, *Miturga* 74, 114
fugax, *Cryptocheilus* 84
 Cycloctenus 114
 Pompilus 66, 84
 Priocnemis 71, 72, 84
 Salius 66, 84
 Sphex 66, 84

- Sphictostethus* 13–17, 19, 21, 24k, 28, 39,
63, 64, 66k, 61k, 67, 76, 77, 79, 80, 82,
83, **84**, 91, 108, 111, 114
- fujax* 84
- geiri*, *Aucklandella* 15
- Gonaporus* 94
- gravesii*, *Pompilus* 63
- Sphictostethus* 19, 64
- Haploneura* 63
- Haploneurion* 63, 64
- hersilia*, *Degithina* 15
- Hexathele* spp. 35
- hilaris*, *Lycosa* 59, 112, 113
- Holoplatys* sp. 000
- Homonotus* 94
- huttoni*, *Agenia* 46, 49
- Cantuaria* 112
- Clubiona* 112, 113
- Pseudagenia* 46
- Priocnemis* 84, 90, 93
- Salius* 84
- huttonii*, *Degithina* 84, 91, 93
- Ichneumon* 84, 90
- Idopompilus* 94
- ignea*, *Phymatophaea* 15
- insularis*, *Epipompiloides* 95
- Epipompilus* 10, 13–18, 21, 24k, 43–45,
51, 94, **95**, 108–110, 112
- Ixeuticus* spp. 83
- janus*, *Neoramia* 114
- lateritus*, *Exeirus* 29
- Leioproctus* (*Nesocolletes*) sp. 59
- leodacus*, *Levansa* 15
- lineicollis*, *Sphaenelater* 15
- livor*, *Matachia* 114
- lotatorius*, *Pterocormus* 93
- Lycosa* spp. 52, 112, 113
- Macromerini 19, 64
- maculipennis*, *Priocnemis* 84, 90, 93
- Proctotrupes* 15, 16
- mamoea*, *Neoramia* 113
- maoricus*, *Hypodrassodes* 112–114
- marginatus*, *Priocnemis* 38, 43
- Salius* 38
- martius*, *Ixeuticus* 113, 114
- matua*, *Neoramia* 108
- maximiliani*, *Epipompilus* 95
- minor*, *Dolomedes* 75, 112, 113
- minus*, *Haploneurion* 64
- minuta*, *Toxopsiella* 113
- Miturga* spp. 112, 113
- monachus*, *Chirodamus* 30, 33
- Pompilus* 29, 33
- Priocnemis* 13, 15–17, 19, 20, 24k, 27,
28, 30–32k, **33**, 41, 50, 70, 75, 108–
110, 112
- Salius* 33
- Trichocurgus* 33
- monarchus*, *Pompilus* 33
- monticola*, *Leioproctus* 62
- montrouzieri*, *Priocnemis* 64
- Neoramia* spp. 83, 113, 114
- niger*, *Eresus* 94
- nigrocollis*, *Gastrosarus* 15, 16
- nitida*, *Chirodamus* 66
- Priocnemis* 66
- Sphex* 10, 30, 63, 64, 66, 71, 72
- nitidiventris*, *Priocnemis* 15, 17, 20, 24k, 30, 32k,
33k, **46**, 51–57, 75, 108–110, 112
- Salius* 46, 55
- nitidiventris* group **46**, 83
- nitidus*, *Chrysocurgus* 66
- Pompilus* 66
- Salius* 66
- Sphictostethus* 13–15, 19, 21, 24k, 63, 64,
65k, 66k, **66**, 77, 80, 82–85, 87, 90, 93,
108, 109, 111, 113
- obscurus*, *Haploneurion* 64
- omnivora*, *Liothula* 101
- ordishi*, *Priocnemis* 15, 17, 20, 24k, 29, 30, 32k,
33k, 46, 47, 50, **51**, 108–110, 113
- orientalis*, *Toxopsiella* 113
- oroua*, *Neoramia* 113
- otagoa*, *Neoramia* 113, 114
- Paraferreola* 94
- parryi*, *Neocicindela* 59
- parva*, *Miturga* 114
- pascoei*, *Priocnemis* 93
- peculiaris*, *Clubiona* 112–114
- PEPSINAE 17, 20, 22k, **25**
- Pepsini 17, 22k, **25**
- pernix*, *Pollenia* 15
- Plagioceps* 94
- planiceps*, *Trite* 102, 114
- Platyderes* 94
- plumbius*, *Pompilus* 46, 51
- Poecilopompilus* 17
- POMPILIDAE **24**
- POMPILINAE 17, 18, 20, 22k, **93**
- pretiosa*, *Priocnemis* 64
- Priocnemis* 18–21, 22k, **29**, 63, 64
- Psepholax* spp. 91, 92
- Pseudageniini 64
- Pseudoclavelia* 94
- Psorthaspis* 94

Salius 25, 93
Salticus sp. 114
sexpunctata, *Sphex* 25
sordidum, *Lasioglossum* 62
sorenseni, *Gradungula* 112
Sphictostethus 17, 19, 22k, **63**
spinolae, *Pison* 112
stewarti, *Cantuaria* 112
straznitskii, *Benhamyia* 15, 16
subfasciata, *Morova* 101

Taeniaporus 94
thaumastarius, *Salius* 64
thileniusi, *Megadictyna* 113
thoracica, *Ferreola* 94
Toxopsiella spp. 113
thyllma, *Aucklandella* 15
triangularis, *Salius* 33
Trichocurgus 18–21, **29**, 30k, 64

Trite spp. 52
tula, *Amphinecta* 113
utetes, *Aucklandella* 15
verecunda, *Huttonobasseria* 15
versicolor, *Sphex* 25
wakefieldi, *Chrysocurgus* 66
 Priocnemis 66
 Salius 66
wakefieldii, *Priocnemis* 66, 71, 72
 Salius 66, 93
williamsi, *Epicostethus* 95
xanthochrous, *Calopompilus* 64
 Sphictostethus 17, 64
xanthopus, *Agenia* 64
xenos, *Priocnemis* 84, 90, 91, 93
 Salius 84

TAXON :

This proforma data sheet may be photocopied as required; copyright is waived. Use the back for data such as host records.

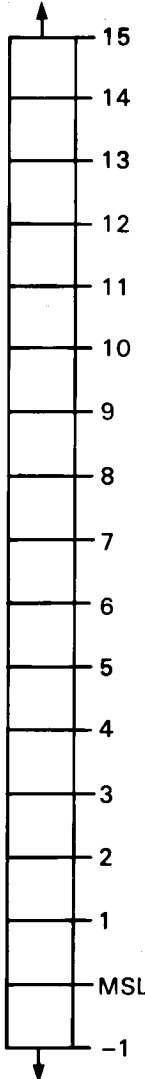

ALTITUDINAL DISTRIBUTION
 (MSL, mean sea level)
 The range of altitude for each scale division may be set according to need, but should be in metric units.

- OFFSHORE ISLANDS**
- Kermadecs
 - Three Kings
 - Chathams
 - Snares
 - Bounty
 - Antipodes
 - Aucklands
 - Campbell

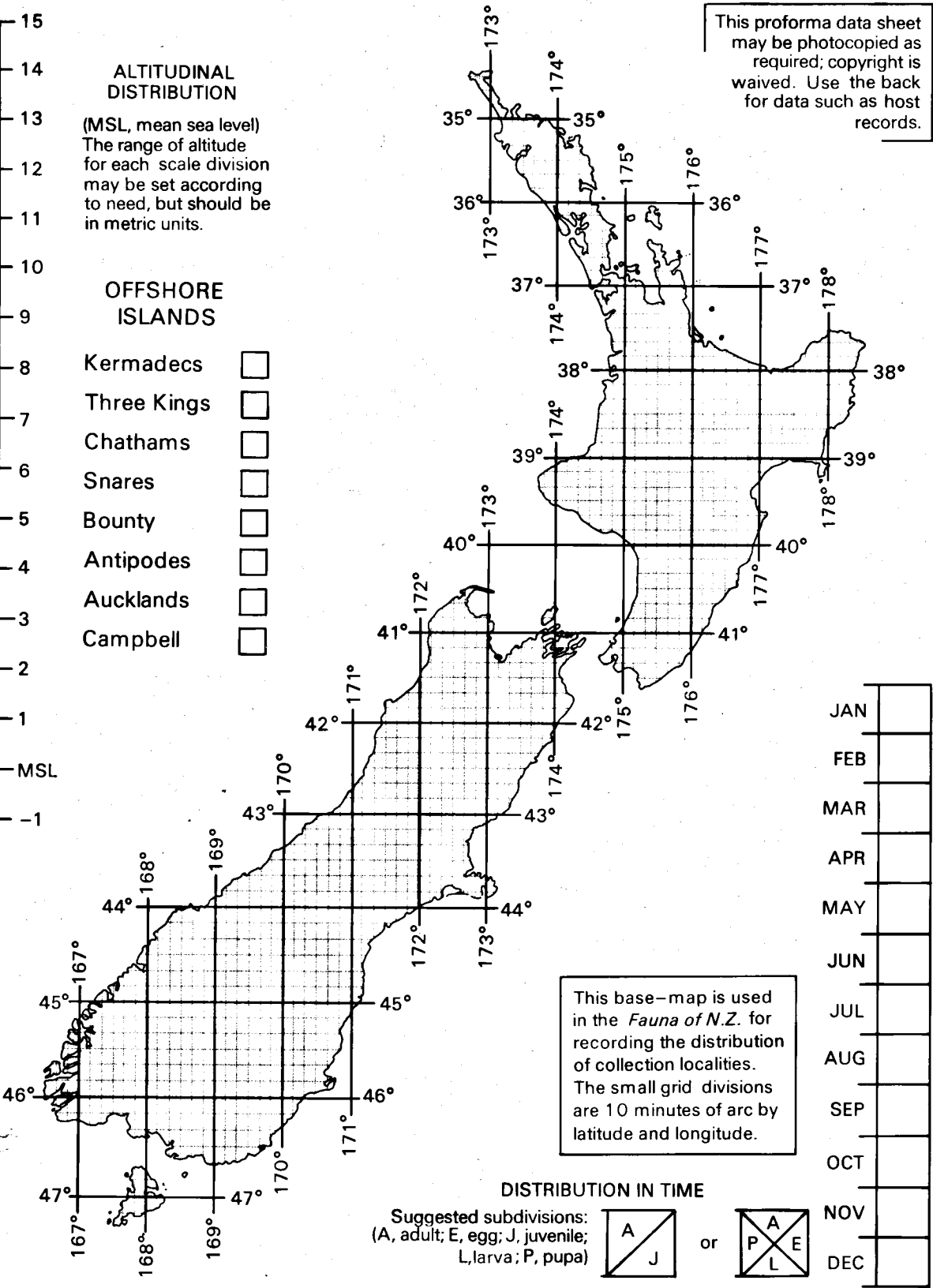

This base-map is used in the *Fauna of N.Z.* for recording the distribution of collection localities. The small grid divisions are 10 minutes of arc by latitude and longitude.

JAN	
FEB	
MAR	
APR	
MAY	
JUN	
JUL	
AUG	
SEP	
OCT	
NOV	
DEC	

DISTRIBUTION IN TIME
 Suggested subdivisions: or
 (A, adult; E, egg; J, juvenile; L, larva; P, pupa)

Fauna of New Zealand



Number 12

Pompilidae (Insecta: Hymenoptera)

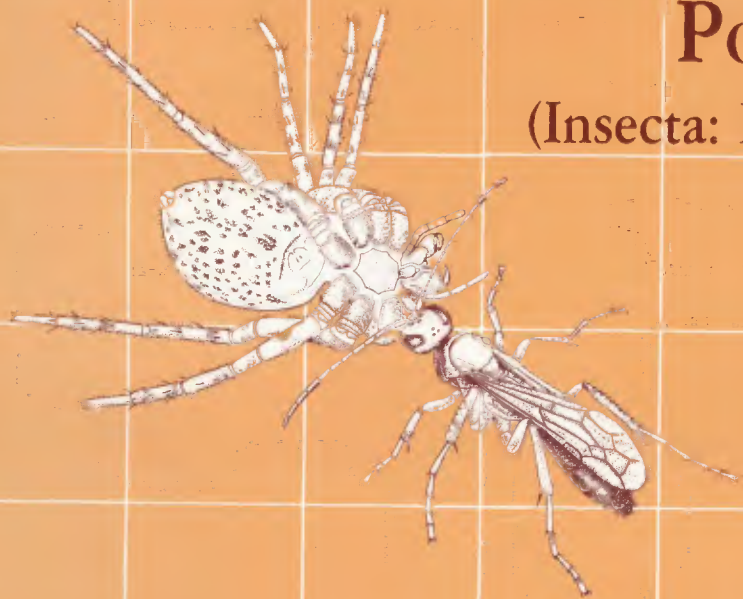

A. C. Harris

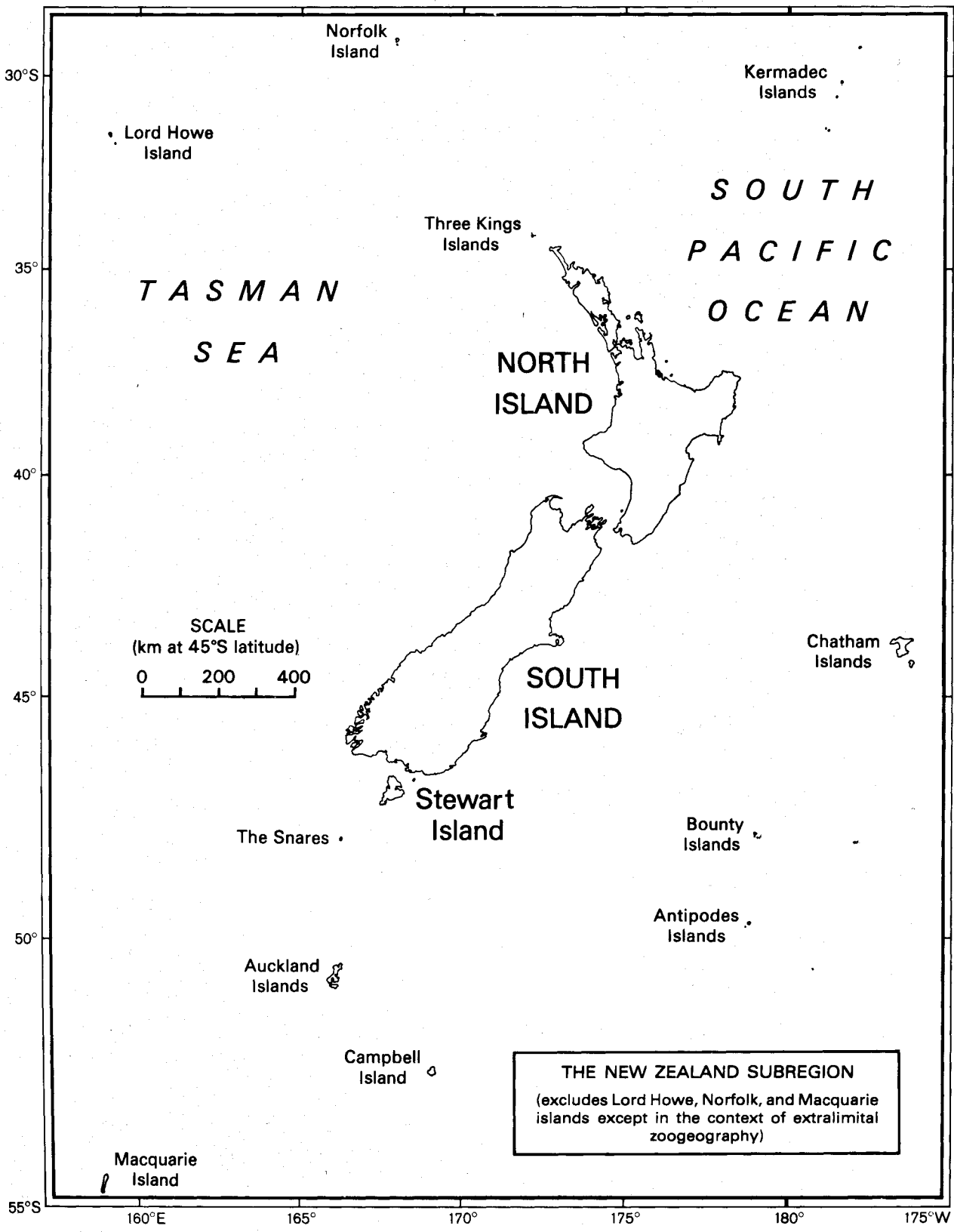

Norfolk Island

Kermadec Islands

Lord Howe Island

SOUTH
PACIFIC
OCEAN

Three Kings Islands

TASMAN
SEA

NORTH
ISLAND

Chatham Islands

SCALE
(km at 45°S latitude)
0 200 400

SOUTH
ISLAND

Stewart
Island

The Snares

Bounty
Islands

Antipodes
Islands

Auckland
Islands

Campbell
Island

THE NEW ZEALAND SUBREGION
(excludes Lord Howe, Norfolk, and Macquarie
islands except in the context of extralimital
zoogeography)

Macquarie
Island

30°S 35° 40° 45° 50° 55°S
160°E 165° 170° 175° 180° 175°W

North Island

- AK - Auckland
- BP - Bay of Plenty
- CL - Coromandel
- GB - Gisborne
- HB - Hawkes Bay
- ND - Northland
- RI - Rangitikei
- TK - Taranaki
- TO - Taupo
- WA - Wairarapa
- WI - Wanganui
- WN - Wellington
- WO - Waikato

South Island

- BR - Buller
- CO - Central Otago
- DN - Dunedin
- FD - Fiordland
- KA - Kaikoura

- MB - Marlborough
- MC - Mid Canterbury
- MK - Mackenzie
- NC - North Canterbury
- NN - Nelson
- OL - Otago Lakes
- SC - South Canterbury
- SD - Marlborough Sounds
- SL - Southland
- WD - Westland

SI - Stewart Island

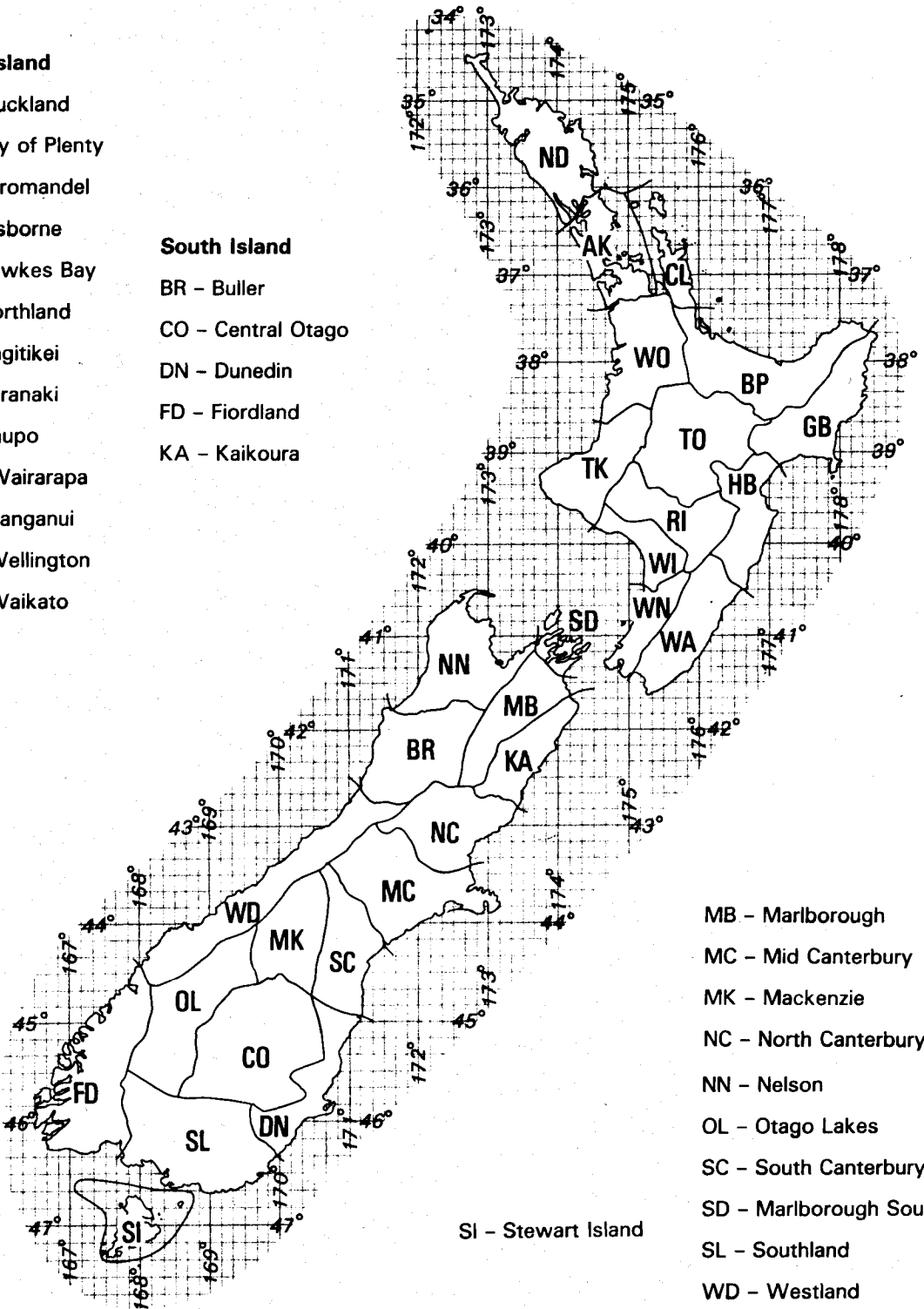

Area codes and boundaries proposed by Crosby *et al.* (1976)
for use with specimen locality data

Fauna of New Zealand

This series of refereed occasional publications has been established with two major objectives: to encourage those with expert knowledge of elements in the New Zealand fauna to publish concise yet comprehensive accounts; and to provide a means of identification accessible to the non-specialist. It will deal with non-marine invertebrates, since the vertebrates are well documented, and marine forms are covered by the series *Marine Fauna of New Zealand*.

Contributors should discuss their intentions with an appropriate member of the *Fauna* Advisory Group or with the Series Editor before commencing work (for names and addresses, see page ii). All necessary guidance will be given.

Persons wishing to receive issues of the *Fauna* should address inquiries to the Publications Officer, Science Information Publishing Centre, DSIR, P.O. Box 9741, Wellington, New Zealand, who will maintain standing orders in three categories, as follows. 'A' — an invoice will be sent for each number, as soon after publication as possible. 'B' — essentially as for 'A', but invoices will be sent only for those numbers in a nominated field of interest (e.g., beetles only, mites only). 'C' — updated catalogues and order forms will be sent from time to time. Orders should be accompanied by full payment, including postage; rates quoted are surface mail, New Zealand and overseas. New Zealand subscribers please add 10% GST to the total purchase price.

CHECKLIST OF TAXA

INTRODUCTION

KEYS TO TAXA

DESCRIPTIONS

HOST RECORDS

ILLUSTRATIONS

IN PRINT

No. 1 Terebrantia (Insecta: Thysanoptera), by Laurence A. Mound & Annette K. Walker. ISBN 0-477-06687-9. Published 23 December 1982. Price NZ\$8.50 + 0.85 (OS 2.20).

No. 2 Osoriinae (Insecta: Coleoptera: Staphylinidae), by H. Pauline McColl. ISBN 0-477-06688-7. Published 23 December 1982. Second impression May 1983. Price NZ\$8.50 + 0.85 (OS 2.20).

No. 3 Anthribidae (Insecta: Coleoptera), by B. A. Holloway. ISBN 0-477-06703-4. Published 23 December 1982. Second impression February 1985. Price NZ\$10.00 + 1.35 (OS 3.50).

No. 4 Eriophyoidea except Eriophyinae (Arachnida: Acari), by D. C. M. Manson. ISBN 0-477-06745-X. Published 12 November 1984. Price NZ\$10.50 + 0.85 (OS 2.20).

No. 5 Eriophyinae (Arachnida: Acari: Eriophyoidea), by D. C. M. Manson. ISBN 0-477-06746-8. Published 14 November 1984. Price NZ\$9.00 + 0.85 (OS 2.20).

No. 6 Hydraenidae (Insecta: Coleoptera), by R. G. Ordish. ISBN 0-477-06747-6. Published 12 November 1984. Price NZ\$7.50 + 0.85 (OS 2.20).

No. 7 Cryptostigmata (Arachnida: Acari) — a concise review, by M. Luxton. ISBN 0-477-06762-X. Published 8 December 1985. Price NZ\$14.50 + 0.85 (OS 2.20).

No. 8 Calliphoridae (Insecta: Diptera), by James P. Dear. ISBN 0-477-06764-6. Published 24 February 1986. Price NZ\$14.00 + 0.85 (OS 2.20).

No. 9 Protura (Insecta), by S. L. Tuxen. ISBN 0-477-06765-4. Published 24 February 1986. Price NZ\$12.00 + 0.55 (OS 1.20).

No. 10 Tubulifera (Insecta: Thysanoptera), by Laurence A. Mound & Annette K. Walker. ISBN 0-477-06784-0. Published 22 September 1986. Price NZ\$28.50 + 0.85 (OS 3.00).

No. 11 Pseudococcidae (Insecta: Hemiptera), by J. M. Cox. ISBN 0-477-06791-3. Published 7 April 1987. 232 p. Price NZ\$43.00 + 2.40 (OS 6.95).

No. 12 Pompilidae (Insecta: Hymenoptera), by A. C. Harris. ISBN 0-477-02501-3. 160 p. Publication date and price to be announced.

IN PREPARATION (and scheduled for early publication)

Arachnida Ixodidae, by G. W. Ramsay.

Crustacea Harpacticoida, by M. H. Lewis. Talitridae, by K. W. Duncan.

Insecta Carabid subfamilies, by P. M. Johns. Key to families of Coleoptera, by J. C. Watt. Staphylinid subfamilies, by P. M. Hammond. Pentatomidae, by C. F. Butcher. Psylloidea, by P. J. Dale. Ambositrinae, by I. Naumann. Apoidea, by B. J. Donovan. Chalcidoidea (part), by J. S. Noyes & E. W. Valentine. Pompilidae, by A. C. Harris. Catalogue of Lepidoptera types, by J. S. Dugdale. Nepticulidae, by C. Wilkinson & H. Donner. Neuroptera, by K. A. J. Wise.

Mollusca Introduced Pulmonata, by G. M. Barker. Punctidae, by F. M. Climo. Onychophora, by H. Ruhberg.

This is a PDF facsimile of the printed publication, and is fully searchable. It is supplied for individual use only and is not to be posted on websites (links should be made to the page from which it was downloaded).

No part of this work covered by copyright may be reproduced or copied in any form or by any means (graphic, electronic, or mechanical, including photocopying, recording, taping, information retrieval systems, or otherwise) without the written permission of the publisher.

Fauna of New Zealand website copy 2008,
www.LandcareResearch.co.nz

Harris, A. C. 1987. Pompilidae (Insecta: Hymenoptera). *Fauna of New Zealand* 12, 160 pp

Date of publication: 13 November 1987
Fauna of New Zealand, ISSN 0111-5383; 12
ISBN 0-477-02501-3

New Zealand Pompilidae. Scanned images from BUGZ project (www.bugz.org.nz) provided by Stephen Pawson for OCR. Text OCR'd and corrected for this searchable PDF by Trevor Crosby, *FNZ* series editor, 2 September 2008. Users may extract text from this PDF for their own use, but must check it against the original document for text sequence, accuracy, and formatting.